

エアラインキット / Air Line Kit
AL-H1206

取扱説明書 / OPERATION MANUAL



日本語：P1 - P9 / English：P11 - P19

OM-K0655 001

Thank you for purchasing the "AL - H1206 " Air Line Kit. This Air Line Kit designed for adjust the air supply flow and oil amount for automatic mist lubrication to Air Grinder. The Air Grinder and a Compressor are required in addition to this Air Line Kit. Read this and all the associated component Operation Manuals carefully before use. Always keep this Operation Manual in a place where a user can referred to for reference at any time.

1. CAUTIONS FOR HANDLING AND OPERATION

- Read these warnings and cautions carefully and only use in the manner intended.
- These warnings and cautions are intended to avoid potential hazards that could result in personal injury to the operator or damage to the device. These are classified as follows in accordance with the seriousness of the risk.

Class	Degree of Risk
 WARNING	A safety hazard could result in bodily injury or damage to the device if the safety instructions are not properly followed.
 CAUTION	A hazard that could result in light or moderate bodily injury or damage to the device if the safety instructions are not followed.

WARNING

- ① **Handling**
Connection to the Air Line Kit should be performed by a person with experience with compressed air and air compressors.
- ② **Air Pressure**
Compressed air is required. Do not exceed an air pressure of 1.0MPa (145psi) at primary side and 0.85MPa (123.3psi) at secondary side of the Air Line Kit.
- ③ **Use of Clean Air**
Do not use compressed air contaminated with chemicals, oil compounds, organic solvents, salinity or corrosive gasses in order to avoid damage to the device.
- ④ **Connection of connection hose and supply air / oil hose**
Connect the input connection hose and supply air / oil hose securely to avoid accidental disconnection during use. Input air pressure should never exceed 1.0MPa (145psi). Pressure exceeding 1.0MPa (145psi) may cause the connection hose and supply air / oil hose to rupture.
- ⑤ **Inlet and Outlet Connections**
Do not hit, impact or cause shock to the Inlet or Outlet Connector Connections. Never put undo stress or load on the Inlet or Outlet Connector Connections. Any damage to these components can cause air leakage and the inability of the inlet or outlet quick disconnect to adequately secure the connection hose and supply air / oil hose.
- ⑥ **Mounting the Air Line Kit**
When installing the Air Line Kit, securely install the Air Line Kit by mounting it on a flat, level surface. If the Air Line Kit is dropped, damage to the Air Line Kit and injury to the operator is possible.
- ⑦ **Filter Regulator Bowl**
 - The bowl is made of a polycarbonate.
Do not use the Air Line Kit in conditions where chemicals or organic solvents are present in the atmosphere.
 - Do not remove the bowl guard. Using the Air Line Kit without the bowl guard may cause injury to the operator should the bowl burst.
 - When removing the bowl from the regulator, remove all pressure from the Input and Outlet sides of the Air Line Kit.

⚠ CAUTION

① Use of dry air

Using compressed air containing excessive moisture could result in malfunction or failure of the Grinder and motor. If excessive moisture or condensation are found in Filter Regulator Bowl, it will be necessary to install a dryer and larger Air Filter on the primary side of the Air Line Kit to prevent and remove excessive moisture.

② Draining

Be sure to drain moisture and condensation from Filter Regulator Bowl regularly to avoid moisture being carried to the Grinder and motor.

③ Installation Location

Place this Air Line Kit on a flat and level surface.

If mounting on a wall, check if the wall is flat, and securely mount the Air Line Kit in a horizontal direction.

④ Handling

When removing the Bowl or Oil Reservoir for cleaning, carefully remove them as not to cause damage to them.

⚠ CAUTIONS for STORAGE, INSTALLATION and OPERATION

① Do not use the Air Line Kit where corrosive gasses, chemicals, seawater, water, oils or steam exist.

② Do not place in direct sunlight.

③ Do not use where the Air Line Kit is subject to vibration or repetitive shock.

④ Do not use where a heat source or radiated heat exist.





⑤ To conform to " STORAGE, INSTALLATION and OPERATION " (Refer to " 6. SPECIFICATIONS ").

2. BASIC PACKAGE

When opening the package, check if it includes all items listed in " Table. 1 Packing List Contents ".

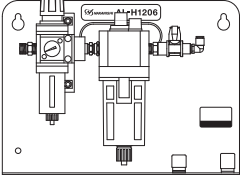
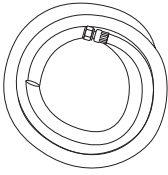
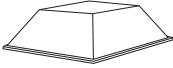
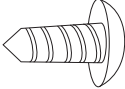
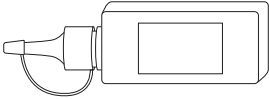
In the event of any shortage, please contact either NAKANISHI (see the " 4. CONTACT US " section) or your local dealer.

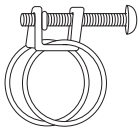
Table. 1 Packing List Contents

<p>Air Line Kit • • 1pc.</p> 	<p>Connection Hose (2m) • • 1pc.</p> 	<p>Rubber Pads • • 4pcs.</p> 
<p>Mounting Screws (Cross-Recessed Truss Tapping Screw : M6 x 20) • • 4pcs.</p> 	<p>Lubricating Oil (K - 211) 70cc • • 1pc.</p> 	<p>Washers • • 4pcs.</p> 
<p>Hose Band • • 1pc.</p> 	<p>CKD Instruction Manual • • 1set</p> 	<p>Operation Manual • • 1set</p> 

3. WARRANTY

We provide a limited warranty for our products. We will repair or replace the products if the cause of failure is due to the following manufactures defects. Please contact us or your local distributor for details.

- ① Defect in manufacturing.
- ② Any shortage of components in the package.
- ③ Where damaged components are found when initially opening the package.
(This shall not apply if the damage was caused by the negligence of a customer)

4. CONTACT US

For your safety and convenience when purchasing our products, we welcome your questions. If you have any questions about operation, maintenance and repair of the product, please contact us.

Contact Us

● For U.S. Market

Company Name : **NSK America Corp**
Industrial Div.
Business Hours : 8:30am to 17:00pm (CST)
(closed Saturday, Sunday and Public Holidays)
U.S. Toll Free No. : 800-585-4675
Telephone No. : 847-843-7664
Fax No. : 847-843-7622
Web Address : www.nskamericacorp.com

● For Other Markets

Company Name : **NAKANISHI INC.** 
Business Hours : 8:00am to 17:00pm
(closed Saturday, Sunday and Public Holidays)
Telephone No. : +81 (0) 289-64-3520
e-mail Address : webmaster-ie@nsk-nakanishi.co.jp

5. FEATURES

- ① The Filter Regulator traps small amounts of water and impure substances from the input air supply. This Air Line Kit is not intended to be used or replace an Air Dryer.
- ② Air pressure can be easily adjusted.
- ③ The oil mist supplied from lubricator to the Air Tool will prolong their service life due to lubrication and the reduction of heat and friction.
- ④ This Air Line Kit is wall mountable.
- ⑤ Attachable Tool Holder.

6. SPECIFICATIONS

Model	AL - H1206	
Primary air pressure	Less than 1.0MPa (145psi)	
Secondary air pressure	Less than 0.85MPa (123.3psi)	
Maximum Operation Pressure	1.0MPa (145psi)	
Maximum Peak Pressure	Less than 1.5MPa (217.6psi)	
Maximum Peak Pressure at Hose Connection	Less than 1.0MPa (145psi)	
Filtration of the Air Filter	5µm	
Maximum Air Volume Allowed	500Nℓ / min	Primary Side Air Pressure : 0.7MPa (101.5psi) Air Pressure Drop : 0.08MPa (11.6psi)
Drain Reservoir Capacity	12cm ³	
Safe Pressure Regulator Operating Range	0.05 - 0.85MPa (7.3 - 123.3psi)	
Pressure Relief	Automatic Relief Valve	
Applied lubricating oil	ISO VG15, Liquid Paraffin, or equivalent	
Oil Reservoir Capacity	85cm ³	
Dimensions	W300mm x D120mm x H228mm	
Weight	2.2Kg	
Operation Environment	Temperature	0 - 40°C
	Humidity	MAX.75% (No condensation)
	Atmospheric pressure	800 - 1,060hPa
Transportation and Storage Environment	Temperature	-10 - 50°C
	Humidity	10 - 85%
	Atmospheric pressure	500 - 1,060hPa

< Option >

Lubricating Oil

Use ISO VG15 Liquid Paraffin (Shell Ondina Oil #15) in the Air Line Kit lubricator bowl (For U.S.A. specification, use Chevron Superla #9).

Model
• Lubricating Oil (K - 211) 70cc
• Lubricating Oil (K - 202) 1 ℓ

7. PARTS NAME

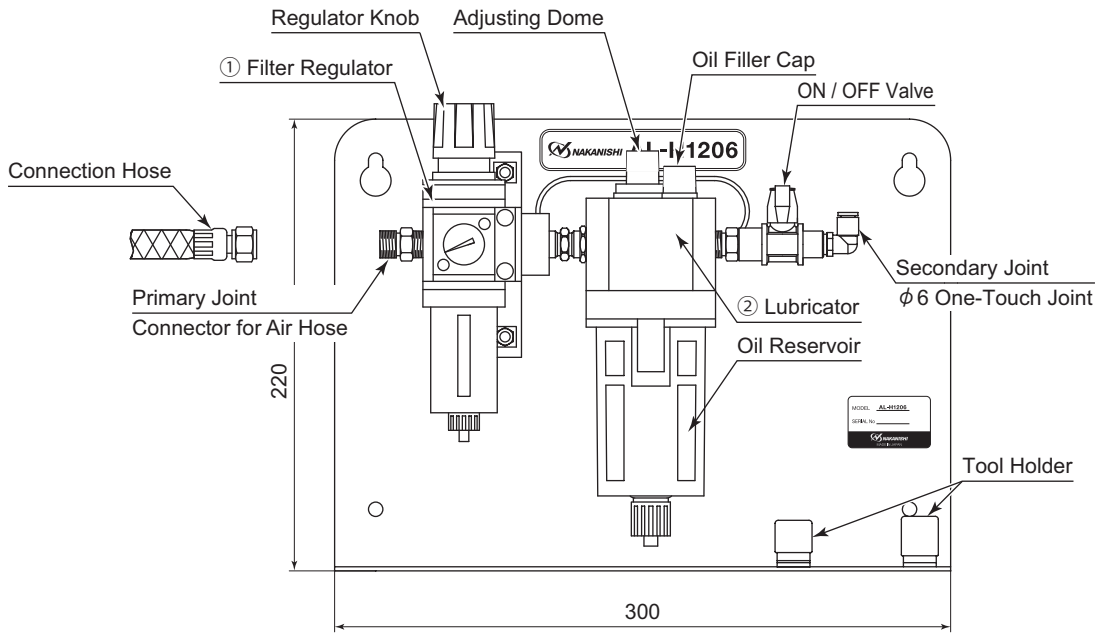

Fig. 1

If the Filter Regulator or Lubricator are damaged, all components are replaceable by the end-user (Refer to Table. 2 and Table. 3).

Table. 2

	Name	Model	Manufacturer
①	Filter Regulator	W1000 - 8 - W	CKD
②	Lubricator	L3000 - 8 - W - C	

Table. 3 Filter Regulator Replacing Option.

Name	Model	Manufacturer
Filter Regulator Consumable Parts Kit (This set includes the Diaphragm Assy, Valve Assy, Bottom spring, Louver, Element, Baffle and Bowl O-Ring.)	W1000 - KIT	CKD
Lubricator Bowl Assy (This set includes the Bowl and Bowl O-Ring.)	F3000 - W - BOWL	

8. OPERATION

8 - 1 Filter Regulator (Fig. 2)

(1) Regulator Section

< Lock and Release of the Regulator Knob >

Regulator Knob is equipped with Lock mechanism.

Release : Pull the Regulator Knob OUT to unlock.

Lock : Push the Regulator Knob IN to the Lock position.

< Adjusting Air Pressure >

Turn the Regulator Knob while watching Pressure Gauge increase or decrease.

H direction : Air pressure is increased.

L direction : Air pressure is decreased.

(2) Filter Section

The water, dirt and debris are separated from the compressed air.

The separated debris is collected in the Bowl.

< Draining >

Opening and closing the Drain Valve.

O direction : Draining.

S direction : Stop draining.

< To divert the drain to another location >

Connect a hose with a $\phi 6\text{mm}$ I.D. (Not included / provided by the end-user.) to the Drain Output Port and divert to another location.

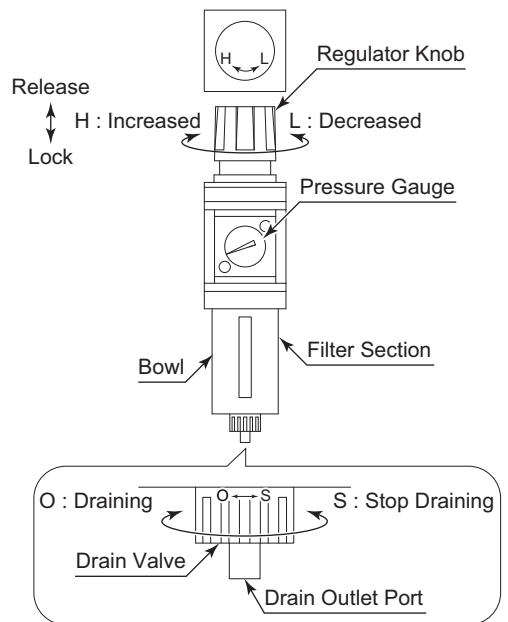

Fig. 2

8 - 2 Lubricator (Fig. 3)

CAUTION

- Make sure to turn the compressed air supply to the Air Line Kit is OFF, before replacing the Lubricating Oil or draining the water in Lubricating Oil.
- Check the Lubricating Oil level everyday and before use. If Lubricating Oil level is low, Fill the oil bowl with Lubricating Oil up to the Upper Oil Limit on the bowl.
- If collected water in the lubricator taints Lubricating Oil, replace the Lubricating Oil immediately.

(1) Oil Amount (Fig. 3)

Check the Oil Amount in the Window.

If the Lubricating Oil level is low, add additional oil.

(Supply Lubricating Oil to Upper Oil Level Limit of Fig. 3.)

(2) Replacing the Lubricating Oil and draining the water in the Lubricating Oil (Fig. 3)

Opening and closing the Hand Operating Knob.

O direction : Draining.

S direction : Stop draining.

< To divert the Lubricating Oil and drain the water to another location >

Connect a hose with a $\phi 6\text{mm}$ I.D. (Not included / provided by the end-user.) to the Oil Outlet Port and divert to another location.

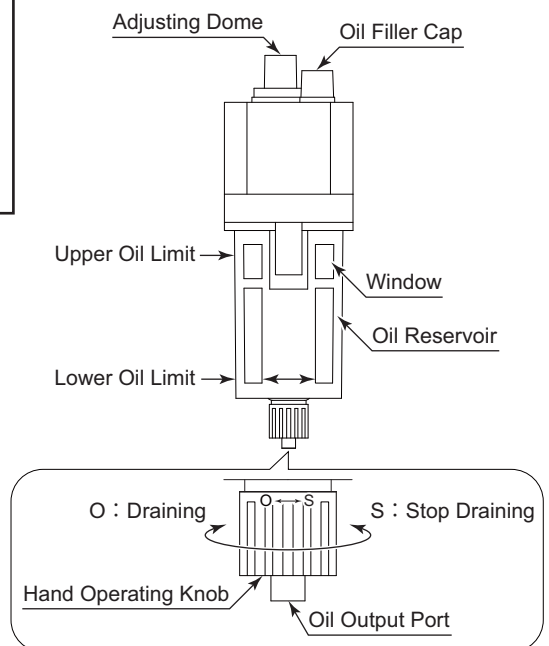

Fig. 3

(3) Adjustment of Oil Drip Rate (Fig. 4)

- ① Set the air pressure to the motors recommended maximum air pressure.
- ② Adjust the Oil Drip Rate to the recommended volume which is 1 to 3 drops / min.
O direction : Increase.
S direction : Decrease.

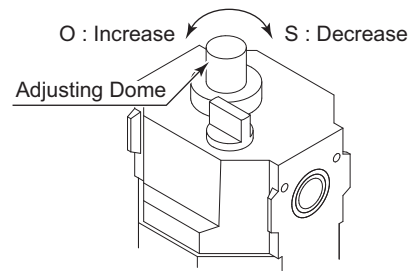

Fig. 4

8 - 3 ON / OFF Valve (Fig. 5)

Turn the ON / OFF Lever located on the valve 90-Degrees to turn the air output ON (Open) or OFF (Close).

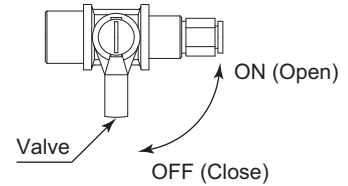

Fig. 5

8 - 4 Tool Holder (Fig. 6)

When not use the Air Tool can be stored.

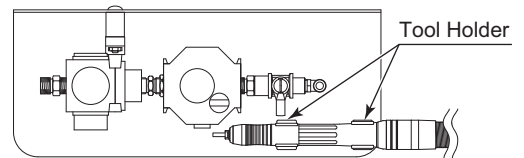

Fig. 6

9. INSTALLATION AND CONNECTION OF THE AIR LINE KIT

⚠ CAUTION

The Air Line Kit install to the horizontal. If " Rear Mounting ", install the Air Line Kit to the horizontally on a vertical wall.

9 - 1 Installation of the Air Line Kit

(1) Horizontal Installation

When the Air Line Kit is mounted from the bottom in a horizontal position Affix the Rubber Pads (Standard Accessories : 4pcs.) to the bottom of the Air Line Kit.

(2) Rear Mounting or Bottom Mounting

Attach the Air Line Kit by the Mounting Screws (Cross-Recessed Truss Tapping Screw : M6 x 20) (Standard Accessories : 4pcs) or M6 screw (not included / provided by the end-user) (Fig . 7).

* When Rear Mounting, attach using the Washers (Standard Accessories) between mounting surface and rear surface of the Base Plate with on horizontal attitude.

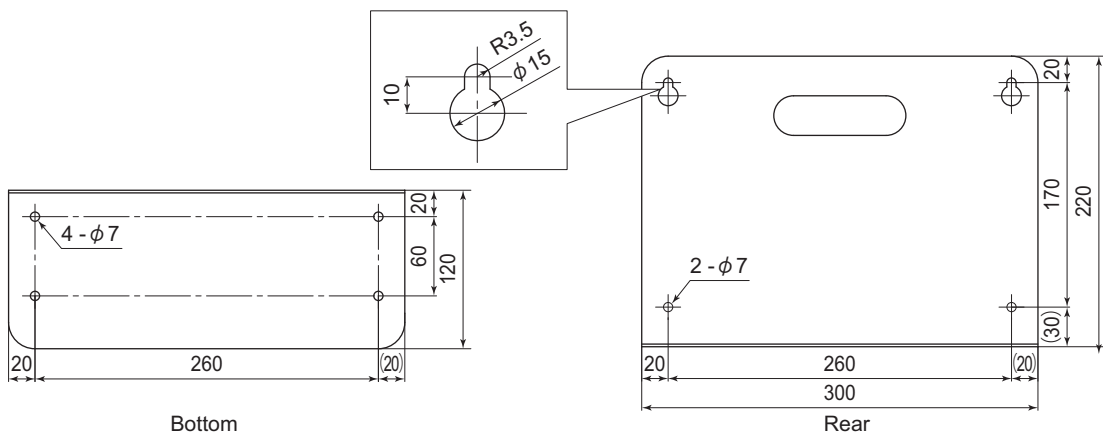

Fig. 7

9 - 2 Connection of the Air Line Kit

- (1) Connect the Connection Hose (Standard Accessory) to the Primary Joint of the Air Line Kit.
- (2) Connect the Filter Joint of the air motor to the Secondary Joint ($\phi 6$ One - Touch Joint) on the Air Line Kit.
- (3) Place " Exhaust Air Silencer / Oil Hose " into an empty container (Exhaust outlet air and oil from the Silencer).

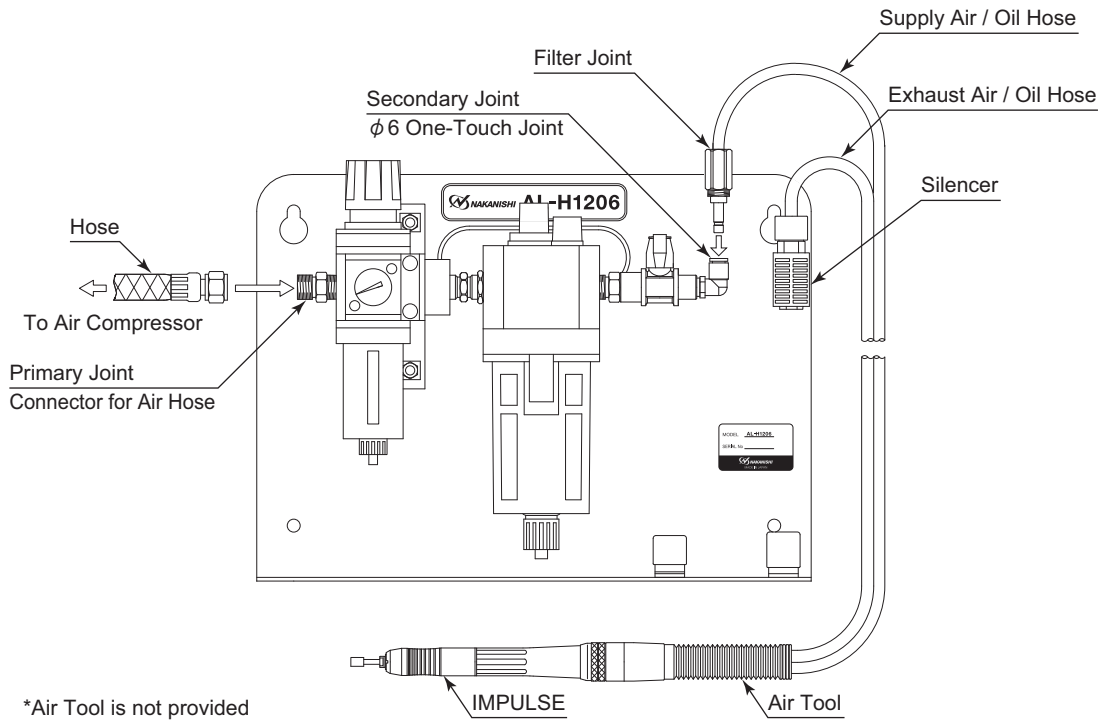

Fig. 8

10. TROUBLESHOOTING

If a problem or concern occur, please check the following items prior to consulting your dealer.

Trouble	Inspection / Corrective Active
Broken connection hose and supply air / oil hose.	Replace the connection hose and supply air / oil hose.
No air flow.	Check the compressor power supply and the air compressor output.
	Check if connection hose and supply air / oil hose is broken, bent or disconnected.
	Check the Filter Regulator and set to the correct air pressure. Check all connection hose and supply air / oil hose connections.
	ON / OFF valve is OFF position. Turn the ON / OFF valve set to ON position.
Air leakage.	Check all threaded joints and re-tighten if necessary.
Low air pressure.	Check the Compressor, Air Circuit, and Filter Regulator.
Low Lubricating Oil or no Lubricating Oil.	<ul style="list-style-type: none"> • Check lubricator for proper Lubricating oil level. Set Lubricating oil drip rate from 1 to 3 drops /min. • Removing the air / oil hose from the Secondary Joint ($\phi 6$ One-Touch Joint), supply a small amount of oil directly into the air / oil hose if bowl is completely empty.
Insufficient number of oil drops.	Air Tool and Reducer internal components will be deprived of oil and the longevity will be dramatically shortened. Set the Oil Drip Rate from 1 to 3 drops / min.
Water in Lubricating Oil Reservoir.	Drain water from Lubricating Oil reservoir and replace with clean Lubricating Oil.
Water, dirt and debris are collected in the Filter Regulator.	Drain water, dirt and debris from the Filter Regulator bowl.

11. DISPOSAL OF THE AIR LINE KIT

When disposal of an Air Line Kit is necessary, follow the instructions from your local government agency for proper disposal of industrial components.

株式会社 **ナカニシ** www.nakanishi-inc.com

本社・工場 〒322-8666 栃木県鹿沼市下日向 700
TEL : 0289(64)3380 FAX : 0289(62)5636

東京事務所 〒110-0015 東京都台東区東上野 4-8-1 TIXTOWER UENO 9F
TEL : 03(5828)7740 FAX : 03(5828)0064

本書の内容は、改善のため予告無しに変更することがあります。

NAKANISHI INC.  www.nakanishi-inc.com

700 Shimohinata, Kanuma, Tochigi 322-8666, Japan

NSK America Corp www.nskamericacorp.com

1800 Global Parkway, Hoffman Estates, IL 60192, USA

Contents are subject to change without notice.