

Spindle

AMH-301

OPERATION MANUAL

OM-K0045E 001

Thank you for purchasing Spindle " AMH - 301 ". This Spindle is developed for the purpose of mainly grinding the deep ribbed holes as the attachment for air motor AM - 300. The E2530 Control Unit, Brushless Motor or Air Motor and Air Line Kit combination are required to drive this Spindle. Read this and all the associated component Operation Manuals carefully before use. Always keep this Operation Manual in a place where a user can referred to for reference at any time.

1. CAUTIONS FOR HANDLING AND OPERATION

- Read these warnings and cautions carefully and only use in the manner intended.
- These warnings and cautions are intended to avoid potential hazards that could result in personal injury to the operator or damage to the device. These are classified as follows in accordance with the seriousness of the risk.

Class	Degree of Risk
⚠ WARNING	A safety hazard could result in bodily injury or damage to the device if the safety instructions are not properly followed.
⚠ CAUTION	A hazard that could result in light or moderate bodily injury or damage to the device if the safety instructions are not followed.

⚠ **WARNING**

- ① This Spindle is not a hand tool. It is designed to be used on CNC machines or special purpose machines.
- ② Do not touch the cutting tool while it is running. It is very dangerous.
- ③ Wear safety glasses, dust mask, and use a protective cover around the Spindle whenever the Spindle is rotating.
- ④ Never connect, disconnect or touch the Power Cord Plug or Motor Cord Plug with wet hands. This may cause an electric shock.
- ⑤ Never operate or handle the Spindle and motor until you have thoroughly read the Operation Manuals and safe operation has been confirmed.
 - 1) To prevent injuries / damages, check the Spindle, motor and cutting tool for proper installation, before operating the Spindle and motor.
 - 2) Before disconnecting the Spindle and motor, always turn the control power off and turn the compressed air supply to the Control Unit off. Then it is safe to remove the Spindle and motor.
- ⑥ When installing a Spindle to a fixed base, make sure the fixed base is grounded in order to avoid the risk of an electric shock.
- ⑦ When installing a tool, tighten the collet correctly and check again the collet before use. Do not over-tighten the collet. This may cause damage to the Spindle.
- ⑧ Do not use bent, broken, chipped, out of round or sub-standard tools, as this may cause them to shatter or explode. Tools with fractures or a bent shank will cause injury to the operator. When using a new tool, rotate it in a low speed and increase speed gradually for safety.
- ⑨ Do not exceed the maximum recommended allowable tool speed. For your safety, use speeds below the maximum allowable speed.
- ⑩ Do not apply excessive force. This may cause tool slippage, tool damage, injury to the operator or loss of concentricity and precision.

⚠ CAUTION



- ① Do not drop or hit this Spindle, as shock can damage to the internal components.
- ② Be sure to clean the collet, the inside of the Spindle before replacing the tool. If ground particles or metal chips stick to the inside of Spindle or the collet, damage to the collet or Spindle can occur due to the loss of precision.
- ③ When cleaning a Spindle, stop the motor and remove debris with a soft brush or a cloth. Do not blow air into the dust proof cover area (refer to section " 6 - 2 Outside View ") with compressed air as foreign particles or cutting debris may get into the ball bearing.
- ④ Always clean the tool shank before installing the tool in the Spindle.
- ⑤ When sizing the correct collet size to the tool shank diameter, a tolerance of +0 ~ - 0.01mm is strongly recommended. A tool shank within the +0 ~ - 0.1mm range is mountable, however, this may cause poor concentricity and or insufficient tool shank gripping force.
- ⑥ Select suitable products or tools for all applications. Do not exceed the capabilities of the Spindle or tools.
- ⑦ Do not stop the supply cooling air for motor during operation of the machine.
Removing the air pressure from the Spindle causes a loss of purging, allowing the Spindle to ingest coolant. This will cause damage to the Spindle.
- ⑧ Carefully direct coolant spray to the tool. Do not spray directly on the Spindle body. If large amount splay directly on the Spindle, it may cause excess load of the motor rotation with loss of durability to the Spindle.
- ⑨ Stop working immediately when abnormal rotation or unusual vibration are observed. Immediately, please check the content of section " 13. TROUBLESHOOTING ".
- ⑩ Always check if the tool, collet are damaged before and after operating.
- ⑪ If the collet show signs of wear or damage, replace it before a malfunction or additional damage occurs.
- ⑫ After installation, repair, initial operation, or long periods of non operation, please refer to section " 11. BREAK-IN PROCEDURE " detailed in Table. 2. When checking the spindle, no vibration or unusual sound should be observed during rotation.
- ⑬ Do not disassemble, modify or attempt to repair this Spindle. Additional damage will occur to the internal components. Service must be performed by NSK NAKANISHI or an authorized service center.
- ⑭ When using this Spindle for mass production, please consider the purchase of an additional Spindle to be used as a back-up in case of emergency.

2. BASIC PACKAGE

When opening the package, check if it includes all items listed in " Table. 1 Packing List Contents ".

In the event of any shortage, please contact either NAKANISHI (see the " 4. CONTACT US " section) or your local dealer.

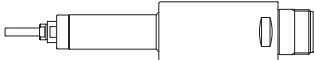
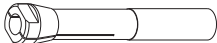
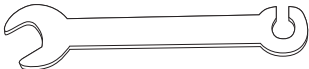
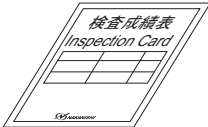
Table. 1 Packing List Contents

<p>Spindle • • 1pc.</p> 	<p>Collet ϕ 3.0mm (CHM - 3.0) or ϕ 3.175mm (CHM - 3.175) • • 1pc.* (For U.S. market ϕ 3.175mm (CHM - 3.175))</p> 	<p>Wrench (7 x 5.1), (6 x 4.5), (20 x 24) • • Each 1pc.</p> 
<p>Inspection Card • • 1pc.</p> 	<p>Operation Manual • • 1set</p> 	

* The collet is attached to the Spindle.

3. WARRANTY

We provide a limited warranty for our products. We will repair or replace the products if the cause of failure is due to the following manufactures defects. Please contact us or your local distributor for details.

- ① Defect in manufacturing.
- ② Any shortage of components in the package.
- ③ Where damaged components are found when initially opening the package.
(This shall not apply if the damage was caused by the negligence of a customer.)

4. CONTACT US

For your safety and convenience when purchasing our products, we welcome your questions. If you have any questions about operation, maintenance and repair of the product, please contact us.

Contact Us

● For U.S. Market

Company Name : **NSK America Corp**
Industrial Div.
Business Hours : 8:30am to 17:00pm (CST)
(closed Saturday, Sunday and Public Holidays)
U.S. Toll Free No. : 800-585-4675
Telephone No. : 847-843-7664
Fax No. : 847-843-7622
Web Address : www.nskamericacorp.com

● For Other Markets

Company Name : **NAKANISHI INC.** 
Business Hours : 8:00am to 17:00pm
(closed Saturday, Sunday and Public Holidays)
Telephone No. : +81 (0) 289-64-3520
e-mail Address : webmaster-ie@nsk-nakanishi.co.jp

5. FEATURES

- ① The Spindle housing is made from precision ground, hardened, stainless steel (SUS) with an outside diameter of ϕ 22.8mm.
- ② The Collet sizes is ϕ 1.0mm, ϕ 1.6mm, ϕ 2.0mm, ϕ 2.35mm, ϕ 3.0mm, ϕ 3.175mm.

6. SPECIFICATIONS AND DIMENSIONS

6 - 1 Specifications

Model	AMH - 301
Maximum Motor Rotation Speed	30,000min ⁻¹ (rpm)
Weight	171g
Noise Level at 1m distance	Less than 70dB (A)

	Temperature	Humidity	Atmospheric Pressure
Operation Environment	0 - 40°C	MAX.75% (No condensation)	700 - 1,060hPa
Transportation and Storage Environment	-10 - + 50°C	10 - 85%	500 - 1,060hPa

< Options >

Collet (CHM - □□)	ϕ 1.0mm, ϕ 1.6mm, ϕ 2.0mm, ϕ 2.35mm, ϕ 3.0mm, ϕ 3.175mm
Grindstone Axis (AGM - 01)	For grinding wheel with ID of ϕ 5mm.

6 - 2 Outside View

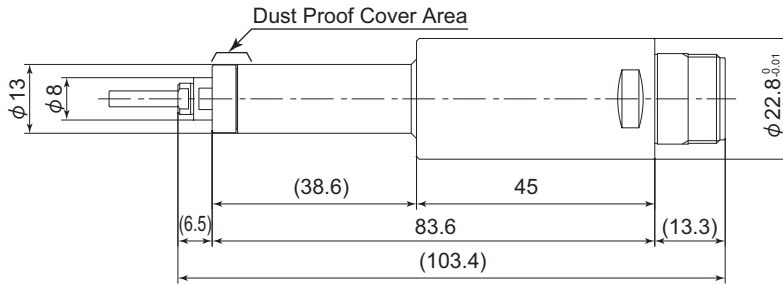

Fig. 1

7. CONNECTION OF THE SPINDLE TO THE MOTOR

⚠ CAUTION

Make sure your hands and all interlocking parts of the Spindle and motor are clean before connecting the motor to the Spindle. This is critical in preventing contaminants from entering the motor or Spindle.

Align the thread on the front end of the motor and the rear of the Spindle, and turn the Spindle clockwise. If the drive shaft of the motor does not engage properly to the drive dog on the Spindle, it may only turn approximately two threads before stopping. DO NOT FORCE THEM TOGETHER. Loosen the Spindle from the motor, rotate the spindle shaft by hand then re-try. The drive shaft and the drive dog must be fully engaged. When fully engaged, secure the motor and Spindle using the provided 20mm wrench (Fig. 2).

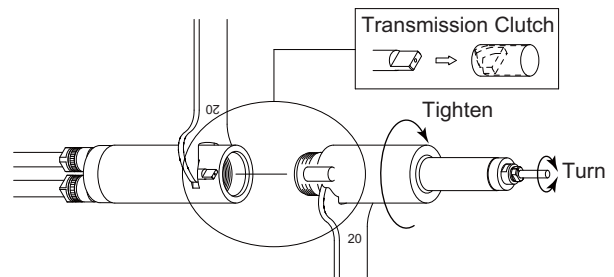

Fig. 2

8. CHANGING THE TOOL

⚠ CAUTION

Do not tighten the collet without inserting a tool or dummy bur as this will result in damage to the collet.

RECOMMENDATION

Please set the cutting tools to minimize the overhang amount. 13mm is the maximum amount of overhang to maintain high accuracy and safety.

- ① Set the provided 7mm wrench on the Spindle.
- ② Place the provided 4.5mm wrench on the collet and turn it counterclockwise to loosen the collet and remove the tool.
- ③ Clean the collet, then insert the new tool and tighten the collet by turning clockwise. Do not over-tighten.

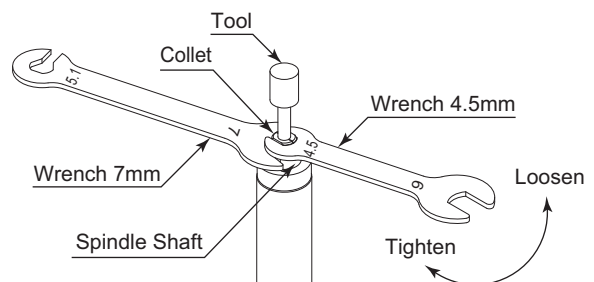

Fig. 3

9. REPLACING THE COLLET

- ① Remove the tool according to the section " 8. CHANGING THE TOOL " procedure above. (Fig. 3)
- ② Place the provided 7mm wrench on the spindle shaft, and turn the top of the collet counterclockwise to remove the collet. (Fig. 4.)
- ③ Install the new collet into the Spindle by turning it clockwise.

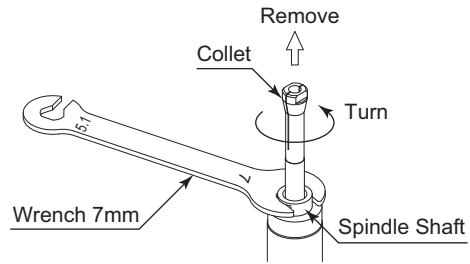

Fig. 4

10. INSTALLATION OF THE SPINDLE

⚠ WARNING

Whenever connecting a Spindle to a brushless motor, or when installing a spindle to a fixed base, ensure that the fixed base is grounded in order to avoid risk of an electric shock.

⚠ CAUTION

- When installing a Spindle, do not hit, drop or cause shock to the Spindle. This may cause damage to internal components and result in malfunctions.
- When mounting the Spindle, be sure to secure within Clamping area etched on the Spindle O.D. If the Spindle is installed incorrectly, damage to the internal components is possible.
- Cautions when tightening the securing bolts on to a Split Type Holder
Do not over-tighten the bolt. This will cause damage to Spindle's precision.
Tighten the bolt until the Spindle body can not be rotated by hand within the fixture.
Extreme tightening is not necessary or recommended.
Apply working force and check that the Spindle is tight before using.

- ① When mounting a Spindle, refer to the Clamping Area etched on the Spindle (Fig. 5).

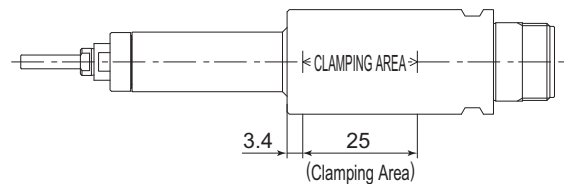

Fig. 5

- ② When installing a Spindle to the holder, recommended installation method is shown Fig 6. Refer to " ③ How to fabricate the Split Type Holder ". If this is not possible, install as shown in Fig. 7.

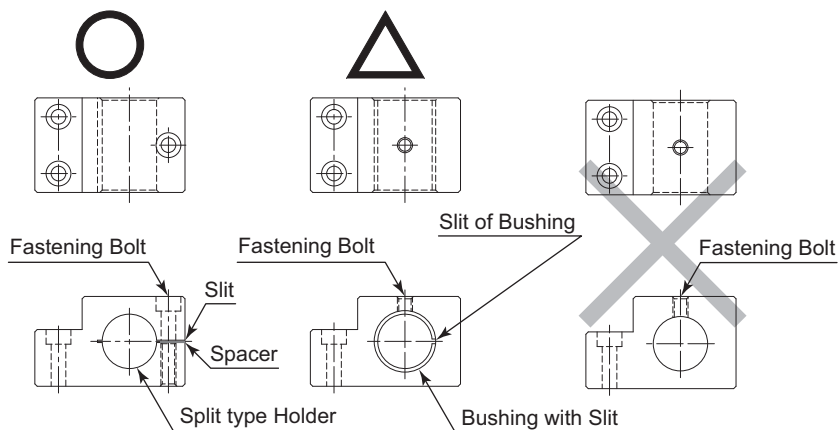

Fig. 6

Fig. 7

Fig. 8

⚠ CAUTION

Do not allow set screws to come directly in contact with the Spindle body as shown in Fig. 8, as this will result in damage to the Spindle housing and internal components.

When installing, never clamp directly over the bearings, as this will result in bearing damage. (Refer to Fig. 9.)

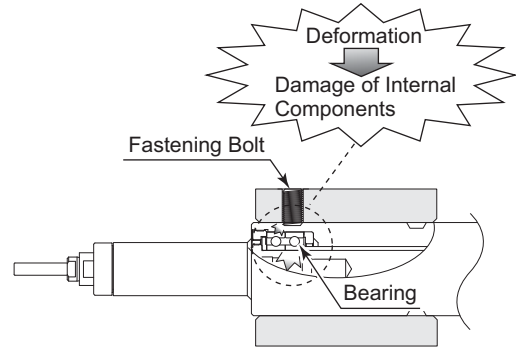

Fig. 9

- ③ How to fabricate the Split Type Holder
- (1) Rough bore the inside diameter of the Split Type Holder.
 - (2) Cut a slit. (Ex. Slit 2mm) wide.
 - (3) Tighten the Screw for Removal and Force Open the Slit Area.
 - (4) Insert a spacer (Ex. thickness = 2mm) into the Slit Area.
 - (5) Loosen the Screw for Removal, and tighten the fastening bolt with its specified torque.
 - (6) Finish the Split Type Holder so that the inside diameter of the Split Type Holder is $\phi 22.8$ with its tolerance range from -0.01mm to -0.015mm , and its roundness and cylindricity of less than $5\mu\text{m}$.
 - (7) When inserting the Spindle loosen the Fastening Bolt, and tighten the Screw for Removal, widening the Slit Area.

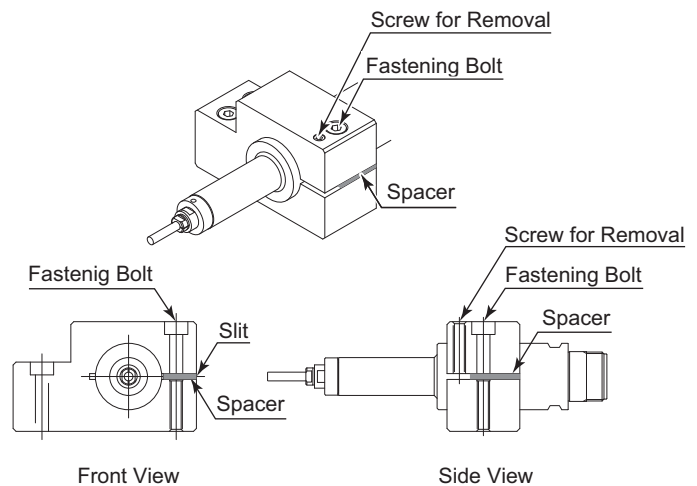

Fig. 10

⚠ CAUTION

- **How to confirm the correct tightening or clamping of the Spindles in the holder : In case of use a brushless motor**
Measure the current value of the Control Unit's power cord by the clamp meter.
Fasten the holder so that the increase in the no-load current value (during rotation at the maximum rotation speed) with the Spindle fastened is 10mA (for type 200V / 230V) or less, compared to the no-load current value (during rotation at the maximum rotation speed) without fastening the Spindle. Do not over-tighten the Fastening Bolt. It may damage Spindle's precision and shorten the life of the bearings.
- The final responsibility for ensuring holder's safety for use in a given application is left to the designer of the equipment in which NAKANISHI's Spindle is installed.
NAKANISHI offers Spindle with a wide variety of capabilities and specifications.
Please carefully check the Spindle's specifications against the requirements of your equipment and verify suitability and safety of the Holder prior to initial use.

11. BREAK-IN PROCEDURE

During transportation, storage or installation, the grease inside the bearings will settle. If the Spindle is suddenly run at high-speed, the grease will be ejected from the bearings, causing excessive heat that will cause bearing damage. After installation, repair, initial operation, or long periods of non operation, please follow the break-in procedure detailed in Table. 2.

Table. 2

< In case of connecting the air motor >

Steps		1	2	3	4	5
Air Pressure	MPa	0.1	0.2	0.3	0.4	0.5
	psi	14.5	29	43.5	58	72.5
Rotation Time (min)		15	10	10	10	15
Items to Check		No Abnormal Noises.	The Spindle housing temperature during the break-in process should not exceed 20 degrees C (36 degrees F) above ambient temperature. Should the Spindle exceed this limit, rest the Spindle for at least 20 minutes and re-start the break in procedure from the beginning. If the housing temperature rises again and exceeds 20 degrees C (36 degrees F) above ambient temperature, check the Spindle.			The Spindle housing temperature during the break-in process should not exceed 20 degrees C (36 degrees F) above ambient temperature.

< In case of connecting the brushless motor >

Steps		1	2	3	4
Rotation Speed (min ⁻¹) (rpm)		5,000	10,000	20,000	30,000
Rotation Time (min)		15	10	10	15
Items to Check		No Abnormal Noises.	The Spindle housing temperature during the break-in process should not exceed 20 degrees C (36 degrees F) above ambient temperature. Should the Spindle exceed this limit, rest the Spindle for at least 20 minutes and re-start the break in procedure from the beginning. If the housing temperature rises again and exceeds 20 degrees C (36 degrees F) above ambient temperature, check the Spindle and motor for proper installation.		The Spindle housing temperature during the break-in process should not exceed 20 degrees C (36 degrees F) above ambient temperature.

12. CAUTIONS WHEN USING GRINDSTONES AND TOOLS

⚠ CAUTION

The maximum surface speed or rpm is always specified for a grindstone. Do not exceed the maximum speed with reference to the calculating chart below. Always follow the grindstone manufacturer's recommendations.

$$\text{Surface Speed (m/s)} = \frac{3.14 \times \text{Diameter (mm)} \times \text{Rotation Speed (min}^{-1}\text{) (rpm)}}{1,000 \times 60}$$

- ① The proper surface speed for general grindstones is 10 - 30m / s.
- ② Do not exceed 13mm of overhang for mounted grindstones as shown in Fig. 11. If the overhang must exceed 13mm, reduce the motor speed in accordance with Table. 3.
- ③ Dress the grindstone prior to use.

- ④ Do not use cutting tools with bent or broken shanks, cracks or excessive run-out.
- ⑤ For grinding, the maximum depth of cut should not exceed 0.01mm radially or axially. Reciprocate the tool several times after each pass to eliminate tool pressure.
- ⑥ Always operate cutting tools within the allowable recommended speed of the cutting tools. Use of a cutting tool outside of the allowable speed of the cutting tools could cause damage to the Spindle and injury to the operator.
- ⑦ Keep the cutting tool shank and collet clean. If contaminants are left in the collet or collet nut, excessive run-out will cause damage to the cutting tool and or Spindle.
- ⑧ Do not strike or disassemble the Spindle.
- ⑨ Please set the cutting tools to minimize the overhang amount. 13mm is the maximum amount of overhang to maintain high accuracy and safety.

Table. 3 Overhang and Speed

Overhang (mm)	Max. Speed (min ⁻¹) (rpm)
20	N x 0.5
25	N x 0.3
50	N x 0.1

* N = Max. Operating Speed with 13mm overhang.

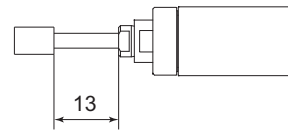

Fig. 11

13. TROUBLESHOOTING

If a problem or concern occur, please check the following items prior to consulting your dealer.

Trouble	Cause	Inspection / Corrective Action
Spindle does not rotate or rotate smoothly.	The Spindle ball bearings have been damaged.	Replace the ball bearings. (Return to NAKANISHI dealer service.)
	The motor has been damaged.	Replace the motor. (Return to NAKANISHI dealer service.)
Overheating during rotation.	Cutting debris has contaminated the ball bearings, and the ball bearings are damaged.	Replace the ball bearings. (Return to NAKANISHI dealer service.)
Abnormal vibration or noise during rotation.	The tool shank is bent.	Replace the tool.
	Cutting debris has contaminated the ball bearing.	Replace the ball bearings. (Return to NAKANISHI dealer service.)
	The Spindle ball bearings have been damaged.	Replace the ball bearings. (Return to NAKANISHI dealer service.)
Tool slippage.	Collet is not correctly installed.	Check and clean the collet. Reinstall the collet.
	The collet is worn.	Replace the collet.
High run-out.	The tool is bent.	Change the tool.
	Collet is not correctly installed.	Secure the collet correctly.
	The collet is worn.	Replace the collet.
	Inside of the spindle is worn.	Replace the spindle shaft. (Return to NAKANISHI dealer service.)
	Contaminants inside the collet or the spindle.	Clean the collet and the inside of the taper and spindle.
	The Spindle ball bearings have been damaged.	Replace the ball bearings. (Return to NAKANISHI dealer service.)

In case of using a brushless motor, refer to the brushless motor and E2530 Control Unit Operation Manuals.

In case of using an air motor, refer to the air motor and the Air Line Kit Operation Manuals.

14. DISPOSAL OF THE SPINDLE

When disposal of a Spindle is necessary, follow the instructions from your local government agency for proper disposal of industrial components.