

Reducer

ARG-011E • ARG-021E

OPERATION MANUAL

Thank you for purchasing the Reducer "ARG - 011E • ARG - 021E". This Reducer is developed for reducing the spindle rotation speed and increasing the torque. This Reducer is driven to be connected between " spindle " and " brushless motor " or " air motor ". Read this and all the associated component Operation Manuals carefully before use. Always keep this Operation Manual in a place where a user can referred to for reference at any time.

1. CAUTIONS FOR HANDLING AND OPERATION

- Read these warnings and cautions carefully and only use in the manner intended.
- These warnings and cautions are intended to avoid potential hazards that could result in personal injury to the operator or damage to the device. These are classified as follows in accordance with the seriousness of the risk.

Class	Degree of Risk
WARNING	A safety hazard could result in bodily injury or damage to the device if the safety instructions are not properly followed.
CAUTION	A hazard that could result in light or moderate bodily injury or damage to the device if the safety instructions are not followed.

WARNING

- The Reducer is not a hand tool. It is to be connected between the NSK spindle and motor and installed on a CNC machine or a special designed machine.
- Do not touch the cutting tool while it is running. It is very dangerous.
- Wear safety glasses, dust mask, and use a protective cover around the Reducer whenever the Reducer is rotating.
- Never connect, disconnect or touch the Power Cord Plug or Motor Cord Plug with wet hands. This may cause an electric shock.
- Never operate or handle the brushless motor, spindle and Reducer until you have thoroughly read the Operation Manuals and safe operation has been confirmed.
 - To prevent injuries / damages, check the brushless motor, spindle, Reducer and cutting tool for proper installation, before operating the brushless motor, spindle and Reducer.
 - Before disconnecting the Reducer from the brushless motor and spindle, always turn the control power off and turn the compressed air supply to the CONTROLLER off. Then it is safe to remove the Reducer.

CAUTION

- Do not exceed the maximum allowable motor speed of 30,000min⁻¹ (rpm).
- Do not drop or hit this Reducer, as shock can damage to the internal components.
- Before use, carefully read " CONTROLLER, motor, spindle, air line kit Operation Manual " regarding the correct connection, operation and cautions when using the CONTROLLER, motor, spindle, air line kit.
- Make sure that the transmission clutches engage firmly, when connecting to the motor and the spindle.
- Stop working immediately when abnormal rotation or unusual vibration are observed. Immediately, please check the content of section " 9. TROUBLESHOOTING ".
- After installation, repair, initial operation, or long periods of non operation, please carry out break-in as follow. Start rotating slowly and over a short period of 15 - 20minutes, increase speed gradually until allowable maximum speed.
- Do not disassemble, modify or attempt to repair this Reducer. Additional damage will occur to the internal components. Service must be performed by NSK NAKANISHI or an authorized service center.
- When using this Reducer for mass production, please consider the purchase of an additional Reducer to be used as a back-up in case of emergency.

2. BASIC PACKAGE

When opening the package, check if it includes all items listed in " Table.1 Packing List Contents ". In the event of any shortage, please contact either NAKANISHI (see the " 4. CONTACT US " section) or your local dealer.

Table 1. Packing List Contents

Reducer • • 1pc. 	Grease dispenser • • 1pc. 	Grease nipple • • 1pc.
Operation Manual • • 1set 		

3. WARRANTY

We provide a limited warranty for our products. We will repair or replace the products if the cause of failure is due to the following manufactures defects. Please contact us or your local distributor for details.

- Defect in manufacturing.
- Any shortage of components in the package.
- Where damaged components are found when initially opening the package.
(This shall not apply if the damage was caused by the negligence of a customer.)

4. CONTACT US

For your safety and convenience when purchasing our products, we welcome your questions. If you have any questions about operation, maintenance and repair of the product, please contact us.

Contact Us

- For U.S. Market

Company Name	: NSK America Corp Industrial Div.
Business Hours	: 8:30am to 17:00pm (CST) (closed Saturday, Sunday and Public Holidays)
U.S. Toll Free No.	: 800-585-4675
Telephone No.	: 847-843-7664
Fax No.	: 847-843-7622
Web Address	: www.nskamericacorp.com

- For Other Markets

Company Name	: NAKANISHI INC.
Business Hours	: 8:00am to 17:00pm (closed Saturday, Sunday and Public Holidays)
Telephone No.	: +81 (0) 289-64-3520
e-mail Address	: webmaster-ie@nsk-nakanishi.co.jp

5. FEATURES

- When the Reducer is connected between the spindle and the motor, it Reduces the spindle rotation speed and increases the torque while keeping the motor speed unchanged.
- The Reducer housing is made from precision ground, hardened, stainless steel (SUS) with an outside diameter of $\phi 30$ mm.
- The Reducer utilizes a planetary gear system.

6. SPECIFICATIONS AND DIMENSIONS

6 - 1 Specifications

Model		ARG - 011E	ARG - 021E
Maximum rotating speed at the cutting tool	For Air Motor	4,750min ⁻¹ (rpm)	1,187min ⁻¹ (rpm)
	For brushless motor	7,500min ⁻¹ (rpm)	1,870min ⁻¹ (rpm)
Maximun allowable Motor Speed	For Air Motor	19,000min ⁻¹ (rpm)	
	For brushless motor	30,000min ⁻¹ (rpm)	
Reduction Ratio		1 / 4	1 / 16
Weight		242g	325g

	Temperature	Humidity	Atmospheric Pressure
Operation Environment	0 - 40°C	MAX.75% (No condensation)	700 - 1,060hPa
Transportation and Storage Environment	-10 - + 50°C	10 - 85%	500 - 1,060hPa

CAUTION

Do not exceed the maximum allowable motor speed 30,000min⁻¹ (rpm) for the spindle and the Reducer.

6 - 2 Outside View

① ARG - 011E

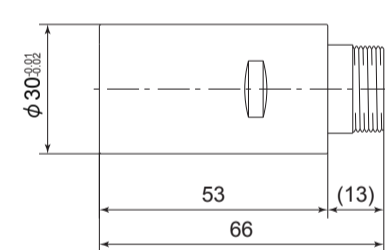

Fig. 1

② ARG - 021E

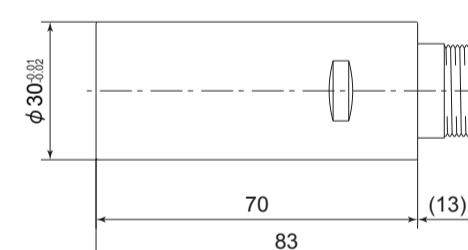

Fig. 2

7. CONNECTION OF THE REDUCER TO THE MOTOR

CAUTION

Make sure your hands and all interlocking parts of the Reducer and motor are clean before connecting the Reducer to the motor. This is critical in preventing contaminants from entering the motor or Reducer.

Align the thread on the front end of the motor and the rear of the Reducer, and turn the Reducer clockwise. If the drive shaft of the motor does not engage properly to the drive dog on the Reducer, it may only turn approximately two threads before stopping. DO NOT FORCE THEM TOGETHER. Loosen the Reducer from the motor, rotate the Reducer shaft by hand then re-try. The drive shaft and the drive dog must be fully engaged. When fully engaged, secure the motor and Reducer using the provided 27mm wrench (Fig. 3).

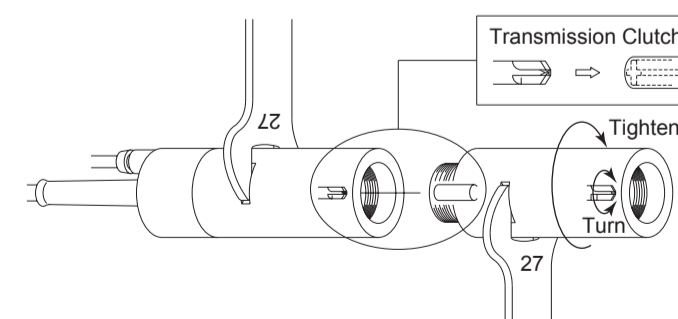

* The wrenches (2 pieces) used here are attached to the motor and spindle respectively.

Fig. 3

8. GREASE INJECTION

CAUTION

- Be sure to use our specified grease. The other type grease may cause damage to Reducer.
- When the thread on the side of the Reducer is removed, need to stop the air supply. Failure to stop the air flow will cause grease to spray out of the grease inlet.

To extend the durability of the reduction gear, inject grease at every 70 - 100 hours in the manner described below. Grease injection prevents the friction of the parts assembled inside as well as heat generation. It also prevents the degradation of grease inside. Periodic grease injection is an important part of routine maintenance.

8 - 1 Grease Injection

- Turn OFF the power switch of the CONTROLLER and stop the air supply. If air motor is used, stop the air supply to the air line kit.
- Remove the Grease Inlet Screw on the Reducer with a screw driver (Fig. 4).

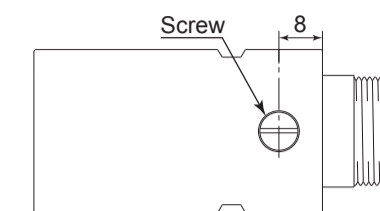

Fig. 4

- Mount the grease nipple on the top of the provided dispenser. And attach the grease nipple on the topped hole removed the thread in the step ②.

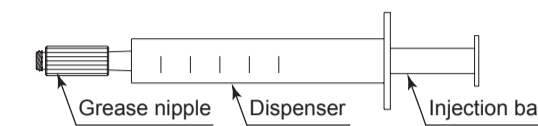

Fig. 5

- Holding the dispenser, turn on the power switch of the CONTROLLER and start the air supply. Set the motor rotation speed " 0 " at the CONTROLLER to avoid the motor rotation (If the air motor is used, hold the dispenser and supply the air to the air motor).
- Inject grease about 0.5mℓ.

CAUTION

Too much grease generates high heat, make sure to only supply the volume of grease as specified.

- Turn OFF the power switch of the CONTROLLER and remove the grease nipple. Finally tighten the screw. (If the air motor is used, remove the grease nipple after the air supply is stopped).

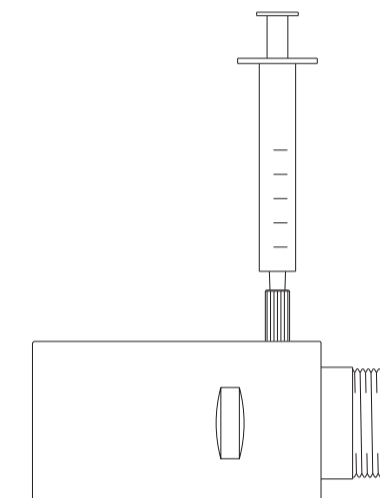

Fig. 6

8 - 2 After Grease Injection

CAUTION

After grease injection, please carry out break-in as follow. Start rotating slowly and over a short period of time, increase speed gradually until allowable maximum speed.

When air supply starts again, excess grease may come out at the spindle end side. Clean off the grease completely.

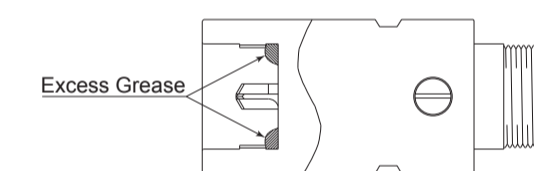

Fig. 7

- Can purchase our specified grease as standard accessories. Please purchase and use the dispenser inject with our specified grease (Table. 2).

Table. 2 Grease

Product	Description	Code No.
	(2.5mℓ)	1547
	(10mℓ)	1550
	(100mℓ)	1549

9. TROUBLESHOOTING

If a problem or concern occurs, please check the following prior to consulting your dealer.

Trouble	Cause	Inspection / Corrective Action
Spindle does not rotate or rotate smoothly.	The spindles ball bearings have been damaged.	Replace the ball bearings. (Return to NAKANISHI dealer service.)
	The reducer gears have been damaged.	Replace the inner gears. (Return to NAKANISHI dealer service.)
Overheating during rotation.	Cutting debris has contaminated the ball bearings, and the ball bearings are damaged.	Replace the ball bearings. (Return to NAKANISHI dealer service.)
Abnormal vibration or noise during rotation.	Cutting debris has contaminated the ball bearing.	
	The spindles ball bearings have been damaged.	Replace the inner gears . (Return to NAKANISHI dealer service.)
The reducer gears have been damaged.		

10. DISPOSAL OF THE REDUCER

When disposal of a Reducer is necessary, follow the instructions from your local government agency for proper disposal of industrial components.