

# E4000 CONTROLLER

## 取扱説明書 / OPERATION MANUAL

日本語 : P1 - P46 / English : P49 - P100 OM-K0596 003





# CONTENTS

---

<b>IMPORTANT INSTRUCTIONS AND WARNINGS - Electric Devices</b> .....	<b>P50</b>
<b>1. CAUTIONS FOR HANDLING AND OPERATION</b> .....	<b>P51</b>
<b>2. BASIC PACKAGE</b> .....	<b>P54</b>
<b>3. WARRANTY</b> .....	<b>P54</b>
<b>4. CONTACT US</b> .....	<b>P55</b>
<b>5. FEATURES</b> .....	<b>P56</b>
<b>6. SPECIFICATIONS AND DIMENSIONS</b> .....	<b>P56</b>
<b>7. SYSTEM CHART</b> .....	<b>P58</b>
<b>8. TORQUE CHARACTERISTICS</b> .....	<b>P59</b>
<b>9. PARTS NAMES</b> .....	<b>P60</b>
<b>10. BRACKET AND RUBBER PAD INSTALLATION</b> .....	<b>P63</b>
<b>11. POWER CORD CONNECTION</b> .....	<b>P65</b>
<b>12. MOTOR CORD CONNECTION</b> .....	<b>P66</b>
<b>13. AIR HOSE CONNECTION</b> .....	<b>P67</b>
<b>14. CHANGING THE CONTROL PANEL</b> .....	<b>P68</b>
<b>15. OPERATION PROCEDURES</b> .....	<b>P69</b>
<b>16. EXTERNAL INPUT / OUTPUT CONNECTOR</b> .....	<b>P71</b>
<b>17. PROTECT FUNCTION</b> .....	<b>P83</b>
<b>18. SETTING OF OPERATING PARAMETERS</b> .....	<b>P86</b>
<b>19. CONTROL PANEL SETTING RESUME FUNCTION</b> .....	<b>P94</b>
<b>20. BREAK IN PROCEDURE</b> .....	<b>P94</b>
<b>21. OPTIONAL DEVICES FOR CONTROLLER</b> .....	<b>P94</b>
<b>22. MAINTENANCE</b> .....	<b>P96</b>
<b>23. TROUBLESHOOTING</b> .....	<b>P99</b>
<b>24. DISPOSAL OF THE CONTROLLER</b> .....	<b>P100</b>

## **IMPORTANT INSTRUCTIONS AND WARNING - Electric Devices**

---

### **WARNING!**

When using electric tools, basic safety precautions should always be followed to reduce the risk of fire, electrical shock and personal injury.

Read all these instructions before operating this product and save these instructions.

### **A. GROUNDING INSTRUCTIONS**

1. In the event of a malfunction or breakdown, grounding provides a path of least resistance for electric current to reduce the risk of electric shock. This tool is equipped with an electric cord with a grounding conductor.
2. Improper connection of the grounding conductor can result in electric shock. The conductor with insulation having an outer surface that is green with yellow stripes is the grounding conductor. If repair or replacement of the electric cord is necessary, do not connect the grounding conductor to a live terminal.
3. Check with a qualified electrician or service person if the grounding instructions are not completely understood, or if in doubt as whether the tool is properly grounded.
4. Repair or replace damaged or worn electrical cord immediately.

### **B. OTHER WARNING INSTRUCTIONS**

1. For your own safety read instruction manual before operating this tool.
2. Replace cracked collet or collet nut immediately.
3. Do not over-tighten the collet nut.
4. Use only NAKANISHI manufactured collets and arbors for grinding and sawing applications.
5. REMOVE ADJUSTING KEYS AND WRENCHES. Always check to see that keys and adjusting wrenches are removed from tool before turning the units Main Power Switch on.
6. KEEP WORK AREA CLEAN. Cluttered areas and benches invite accidents.
7. DO NOT USE IN DANGEROUS ENVIRONMENT. Don't use power tools in damp or wet locations, or expose them to rain.
8. Keep work area well lighted.
9. There is a risk of injury due to accidental starting. Do not use in an area where children may be present.
10. DO NOT FORCE THE TOOL. Never use a tool for an application it was not designed for.
11. USE THE CORRECT TOOL. Do not force tools or attachments to do a job for which it was not designed.
12. WEAR PROPER APPAREL. Do not wear loose clothing, gloves, neck ties, rings, bracelets, or other jewelry that might get caught in moving parts. Nonslip footwear is recommended. Wear protective hair covering to contain long hair.
13. ALWAYS USE SAFETY GLASSES. Everyday eyeglasses only have impact resistant lenses, they are NOT safety glasses. Also use face or dust mask if cutting operation is dusty.
14. SECURE YOUR WORK. Use clamps or a vise to hold work securely at all times.
15. MAINTAIN TOOLS WITH CARE. Keep tools sharp and clean for best performance and to reduce the risk of injury. Follow instructions for changing accessories.
16. DISCONNECT TOOLS before servicing or when changing accessories, such as blades, cutters etc.
17. TO REDUCE THE RISK OF UNINTENTIONAL STARTING. Make sure Main Power Switch is in OFF position before connecting the Power Cord.
18. NEVER LEAVE TOOLS RUNNING UNATTENDED. TURN POWER OFF. Don't leave tool until it comes to a complete stop.
19. For recommended operating speeds for various applications, please follow recommendations of the cutting tool manufacturer.
20. To protective E4000 CONTROLLER or electric wiring from a possible short circuit, place a circuit breaker (MCCB) between the power source and the AC Power Input Terminal Block of E4000 CONTROLLER. Select the circuit breaker with a 10A current capacity.
21. When use the Safety Relay Box, connect the Safety Relay Box to the E4000 CONTROLLER. By doing this, the outer box of Safety Relay Box is grounded and the system will be protected against electric shock.

Thank you for purchasing the E4000 Ultra-Precision, High-Speed spindle system.

The E4000 system was designed for use on CNC lathes and mills, robots, NC lathes and special purpose machines. This system utilizes air to cool the motor and purge the spindle.



Please use an NAKANISHI Air Line Kit to ensure clean, dry, properly regulated air is supplied to the motor and spindle. The E4000 system is capable of being used with coolants and cutting lubricants.

Please read this Operation Manual carefully before use. Also read <Brushless Motor>, <Spindle> and <Air Line Kit> Operation Manuals.

Always keep this Operation Manual in a place where a user can referred to for reference at any time.

## 1. CAUTIONS FOR HANDLING AND OPERATION

- Read these warnings and cautions carefully and only use in the manner intended.
- These warnings and cautions are intended to avoid potential hazards that could result in personal injury to the operator or damage to the device. These are classified as follows in accordance with the seriousness of the risk.

Class	Degree of Risk
 <b>DANGER</b>	<b>Existence of a hazard that could result in personal death or serious injury, if the safety precautions are not followed.</b>
 <b>WARNING</b>	<b>A safety hazard could result in bodily injury or damage to the device if the safety instructions are not properly followed.</b>
 <b>CAUTION</b>	<b>A hazard that could result in light or moderate bodily injury or damage to the device if the safety instructions are not followed.</b>

### **DANGER**

- ① NAKANISHI warns all end-users not to remove the Power Cord, Motor Cord, Protective Covers A and B or Options while the Control Power is ON, or if there is power to the main power cord. Disconnect the main power from its power source before removing the Power Cord, Motor Cord, Protective Covers A and B or Options. Not following these instructions may lead to serious injury or death due to electric shock.
- ② Attach the Protective Covers A and B before use. Touching a power terminal connection by mistake may cause risk that leads to death or serious injury by electric shock.
- ③ Make sure the input power supply is OFF before wiring. If the incoming power supply is ON, it may cause risk that leads to death or serious injury by electric shock
- ④ Be sure to connect the ground wire to the earth ground. Insufficient grounding could cause an electric shock or malfunction.
- ⑤ Be sure to connect the ground wire of the Power cord to the AC Input Power Terminal Block (Earth Mark). Insufficient grounding could cause an electric shock or fire and malfunction.

### **WARNING**

- ① The CONTROLLER is not a hand tool. It is designed to be used on a CNC lathe or special purpose machines.
- ② Do not touch the cutting tool while the spindle and tool are rotating. It is very dangerous.
- ③ Wear safety glasses, dust mask, and use a protective cover around the spindle whenever the spindle is rotating.
- ④ Never connect, disconnect or touch the Power Cord and Motor Cord Plug with wet hands. This may cause an electric shock.
- ⑤ Never operate or handle the CONTROLLER and motor or spindle until you have thoroughly read the owner's manual for each component, and safe operation has been confirmed.
  - 1) To prevent injuries / damages, check the CONTROLLER, motor, spindle and cutting tool for proper installation, then operate the CONTROLLER, motor and spindle.
  - 2) Before disconnecting the CONTROLLER, motor or spindle, always turn the control power OFF and turn the compressed air supply to the CONTROLLER OFF. Then it is safe to remove the CONTROLLER, motor and spindle.

## **WARNING**

- ⑥ Do not use in dangerous environments. Protect the CONTROLLER from moisture and other contaminants. Failure to protect CONTROLLER can result in damage to internal components and injury to the operator.
- ⑦ To protective CONTROLLER or electric wiring from a possible short circuit, place a circuit breaker (MCCB) between the power source and the AC Power Input Terminal Block of the CONTROLLER. Select the circuit breaker with a 10A current capacity.
- ⑧ Check to ensure that the supply voltage is the same as the CONTROLLER rated voltage.
- ⑨ When you use the E4000 Safety Relay Box, connect the E4000 Safety Relay Box to the E4000 CONTROLLER. By doing this, the outer box of E4000 Safety Relay Box is grounded and the system will be protected against electric shock.
- ⑩ When installing a tool, tighten the collet correctly and check again the collet and collet nut before use. Do not over-tighten the collet. This may cause damage to the spindle.
- ⑪ Do not use bent, broken, chipped, out of round or sub-standard tools as they may cause tools to shatter or explode. Tool with fractures or a bent shank will cause injury to the operator. When using a new tool, rotate it at a low speed and increase speed gradually for safety.
- ⑫ Do not exceed the maximum recommended allowable tool speed. For your safety, use speeds below the maximum allowable speed.
- ⑬ Do not apply excessive force. This may cause tool slippage, tool damage, injury to the operator or loss of concentricity and precision.
- ⑭ When installing the motor and the spindle, make sure the Main Power Switch of the CONTROLLER turned OFF before installing.
- ⑮ When installing a motor spindle to a fixed base, make sure the fixed base is grounded in order to avoid the risk of an electric shock.

## **CAUTION**

- ① A motor cooling and spindle purge air is required to operate the system correctly.
- ② The input air line must be connected to the air input joint on the front of the CONTROLLER. Air pressure between 0.2 - 0.35MPa (29.0 - 50.8psi) must be supplied.
- ③ The brushless motor and spindle require air for cooling and purging. Ensure that this air supply is clean and dry. Introduction of dust, moisture and other contaminants into the CONTROLLER, motor and spindle will cause damage to the internal components.
- ④ If water or oil is allowed to enter the CONTROLLER, failure of the CONTROLLER may result.
- ⑤ Do not hit, drop or subject the motor, spindle or CONTROLLER to any type of shock. This will cause damage to internal components and result in a malfunction.
- ⑥ Do not disassemble, modify or attempt to repair the CONTROLLER, motor or spindle as it will damage internal components. There are no user serviceable parts available.
- ⑦ Motor will make a sudden stop when error LED lights or error output signal is generated. Check and correct the cause of the malfunction before continuing use. Failure to correct the problem will result in damage to the CONTROLLER, motor and spindle.
- ⑧ When the warning LED on the CONTROLLER blinks, conditions exist that could result in dangerous operation. Check operating conditions and continue to use only after correcting the problem.
- ⑨ When using CONTROLLER continuously, refer to continuous area on torque Characteristics Graph and check Load Monitor LED for a maximum output of (3 Green LEDs).
- ⑩ Do not install the CONTROLLER next to RF noise sources, as malfunctions can occur.
- ⑪ If smoke, noise or strange odors emanate from the CONTROLLER or motor spindle, immediately turn OFF the Main Power Switch.
- ⑫ Do not place anything on top of the CONTROLLER.
- ⑬ When installing the CONTROLLER, never place them in areas where vibration and shock are present or possible. This may cause a malfunction to occur.
- ⑭ Do not place the CONTROLLER near any source of heat. The temperature inside the CONTROLLER will rise, resulting in a CONTROLLER failure.



## CAUTION





- ⑮ Connect the round terminal lugs of the Power Cord to the AC Power Input Terminal Block of the CONTROLLER securely firmly.
- ⑯ When using in a place where the power conditions are poor, take measures to enable a supplied input power within the specified voltage fluctuation.
- ⑰ Attach the provided Connector Cover for safety and dust proofing when not using Input / Output Connector A, B or EMG Connector.
- ⑱ Do not press the switches on the Control Panel of the CONTROLLER with a sharp-pointed tool.
- ⑲ When disposal of a CONTROLLER is necessary, follow the instructions from your local government agency and dispose as an industrial waste.
- ⑳ Be sure to clean the collet and collet nut, the inside of the spindle before replacing the tool. If ground particles or metal chips stick to the inside of spindle or the collet, damage to the collet or spindle can occur due to the loss of precision.
- ㉑ Always clean the tool shank and the machine spindle taper before installing the tool in the machine.
- ㉒ When sizing the correct collet size to the tool shank diameter, a tolerance of  $+0 \sim -0.01\text{mm}$  is strongly recommended. A tool shank within the  $+0 \sim -0.1\text{mm}$  range is mountable, however, this may cause poor concentricity and or insufficient tool shank gripping force.
- ㉓ Select suitable products or tools for all applications. Do not exceed the capabilities of the spindle or tools.
- ㉔ Carefully direct coolant spray to the tool. Do not spray directly on the motor and spindle body.
- ㉕ Stop working immediately when abnormal rotation or unusual vibrations are observed. If vibrations occur, please check the contents of page number P99 " 23. TROUBLESHOOTING ".
- ㉖ Always check if the tool, collet or collet nut are damaged before and after operating.
- ㉗ After installation, repair, initial operation, or long periods of non operation, please refer to Operation Manual of the spindle / motor spindle detailed in " BREAK-IN PROCEDURE ". When checking the spindle, no vibration or unusual sound should be observed during rotation.

## 2. BASIC PACKAGE

When opening the package, check if it includes all items listed in " Table 1. Packing List Contents ".

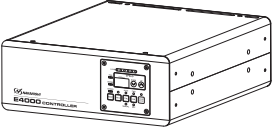
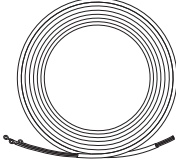
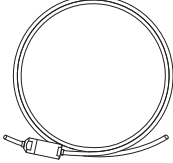
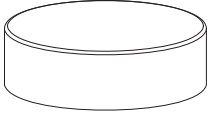
In the event of any shortage, please contact either NAKANISHI (see the " 4. CONTACT US " section) or your local dealer.

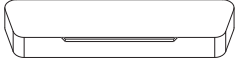
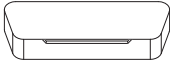
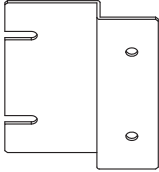
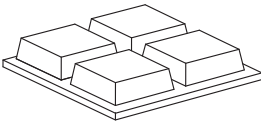
Table 1. Packing List Contents

<p>E4000 CONTROLLER Main Body • • 1pc.</p> 	<p>Power Cord (4m) • • 1pc.</p> 	<p>φ6mm Air Hose with Filter (2m) • • 1pc.</p> 
<p>Connector Cap A • • 1pc.</p> 	<p>Connector Cap B • • 1pc.</p> 	<p>Connector Cap EMG • • 1pc.</p> 
<p>Connector Cover A • • 1pc.</p> 	<p>Connector Cover B • • 1pc.</p> 	<p>Brackets • • 4pcs.</p> 
<p>Rubber Pads (4pcs) • • 1set.</p> 	<p>Operation Manual • • 1set</p> 	<p>WARNING / Error Code Label • • 1set</p> 

\* The Connector Cap A / B, Connector Cap EMG and Connector Cover A / B are attached to the CONTROLLER.

## 3. WARRANTY

We provide a limited warranty for our products. We will repair or replace the products if the cause of failure is due to the following manufacturers defects. Please contact us or your local distributor for details.

- (1) Defect in manufacturing.
- (2) Any shortage of components in the package.
- (3) Where damaged components are found when initially opening the package.  
(This shall not apply if the damage was caused by the negligence of a customer)



## 4. CONTACT US

---

For safe use / purchase of our products, we welcome your questions.

If you have any questions about operation, maintenance and repair of the product, please contact us.

### Contact Us

- For U.S. Market

Company Name : **NSK America Corp**  
Industrial Div.  
Business Hours : 8:30am to 17:00pm (CST)  
(closed Saturday, Sunday and Public Holidays)  
U.S. Toll Free No. : 800-585-4675  
Telephone No. : 847-843-7664  
Fax No. : 847-843-7622  
Web Address : [www.nskamericacorp.com](http://www.nskamericacorp.com)

- For Other Markets

Company Name : **NAKANISHI INC.**   
Business Hours : 8:00am to 17:00pm  
(closed Saturday, Sunday and Public Holidays)  
Telephone No. : +81 (0) 289-64-3520  
e-mail Address : [webmaster-ie@nsk-nakanishi.co.jp](mailto:webmaster-ie@nsk-nakanishi.co.jp)

## 5. FEATURES

- ① Although it is a compact unit with a motor / spindle diameter of 40mm, the E4000 system is capable of outputting high power with a maximum 1,200W, and high torque with a maximum 1.0N·m onto the motor shaft.
- ② The E4000 features a high speed type with a maximum speed of 40,000min<sup>-1</sup> (rpm) and a high torque type with a maximum speed of 20,000min<sup>-1</sup> (rpm) depending on cutting conditions.
- ③ Speed control and protection functions are incorporated in the high performance microprocessor.
- ④ A wide speed range, 1,000 - 40,000 min<sup>-1</sup> (rpm) (20,000 min<sup>-1</sup> (rpm)) and settable speed increment of 100min<sup>-1</sup> (rpm) make high precision machining possible.
- ⑤ Use of an external mechanism such as sequence control allows the E4000 series to be controlled from A CNC / PC Control. In addition, power output can be monitored via external equipment.
- ⑥ The CONTROLLER can be placed horizontally or vertically. It can be installed at various places by using the attached mounting bracket.
- ⑦ Each operation setting can be set with parameters (memory) that match each user's preferred operating method.
- ⑧ Abnormality and malfunctioning status of the CONTROLLER can be checked by error code display by the Error Detection (warning, error) of the system.
- ⑨ An overheat detection sensor is built into the motor, and problems due to abnormal overheating of the motor is prevented before it damage occurs.
- ⑩ A straight type and right angle type electric and air connection is available to meet space limitations.
- ⑪ The motor / spindle housing is made from precision ground, hardened, stainless steel (SUS) with an outside diameter of  $\phi$  40mm.
- ⑫ The motor cord is available from 2m to 8m in increments of 2m to meet machine electrical and NSK Control distances.
- ⑬ The control panel is removable. It can be installed on the rear of the CONTROLLER, allowing for flexibility of operation.
- ⑭ The Control Panel can be installed at a distance of 4m from the CONTROLLER body by using an optional E4000 Control Panel Extension Cord.
- ⑮ In an Emergency Stop condition, the power to the motor can be securely disconnected via a relay by using the E4000 Safety Relay Box. A safety system between the E4000 CONTROLLER and the machine can be configured by utilizing auxiliary contacts.

## 6. SPECIFICATIONS AND DIMENSIONS

### 6 - 1 Specifications of CONTROLLER

Product Name	E4000 CONTROLLER		
Model	NE246		
Input Voltage	AC200 - 240V, 50 / 60Hz, 1 PHASE, 3.2A		
Output	AC48V, 0 - 0.66KHz, 3 PHASE, 7.8A		
Max.Output Power	1,200W (Machine Shaft Output)		
Max.Torque	1.0N·m (Motor : BMS - 4020 / BMS - 4020RA / EM - 4020 / EM - 4020A) 0.5N·m (Motor : BMS - 4040 / BMS - 4040RA / EM - 4040 / EM - 4040A)		
Over Voltage Category	II		
Pollution Degree	Class 2		
Speed Range	1,000 - 20,000min <sup>-1</sup> (rpm) (Motor : BMS - 4020 / BMS - 4020RA / EM - 4020 / EM - 4020A) 1,000 - 40,000min <sup>-1</sup> (rpm) (Motor : BMS - 4040 / BMS - 4040RA / EM - 4040 / EM - 4040A)		
External Control Signal	Input Signal	Photo Coupler : 9 Analog Connections : 1	
	Output Signal	MOS Relay : 8 Analog : 3	Photo Coupler 1 Relay Contact 2 (Safety Relay BOX)



## 6 - 3 Outside View of the CONTROLLER



### CAUTION

Do not stack 2 CONTROLLERS on top of each other. This will increase the heat generated inside the CONTROLLERS, leading to a premature failure.

\*Below is an outside view with the Brackets attached (Standard Accessory).

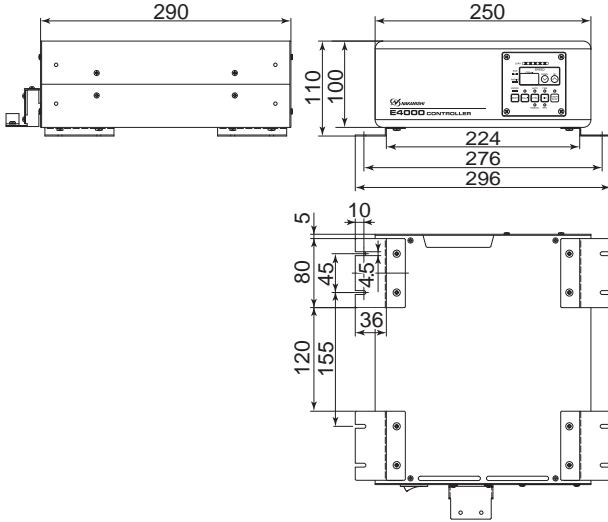

Fig. 1 Bottom Mounting

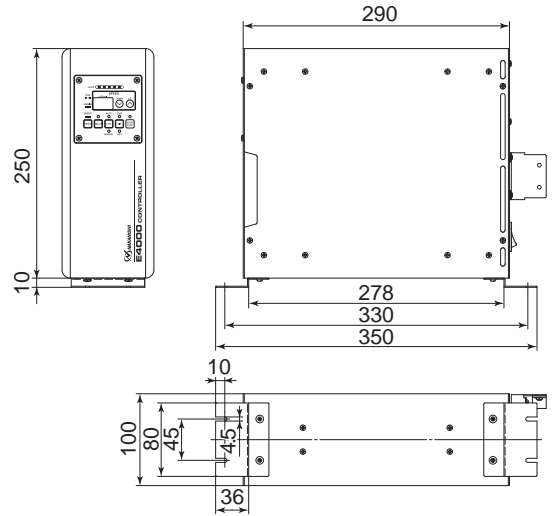

Fig. 2 Vertical Mounting

## 7. SYSTEM CHART

E4000 CONTROLLER can be used in the following the systems (Fig. 3).

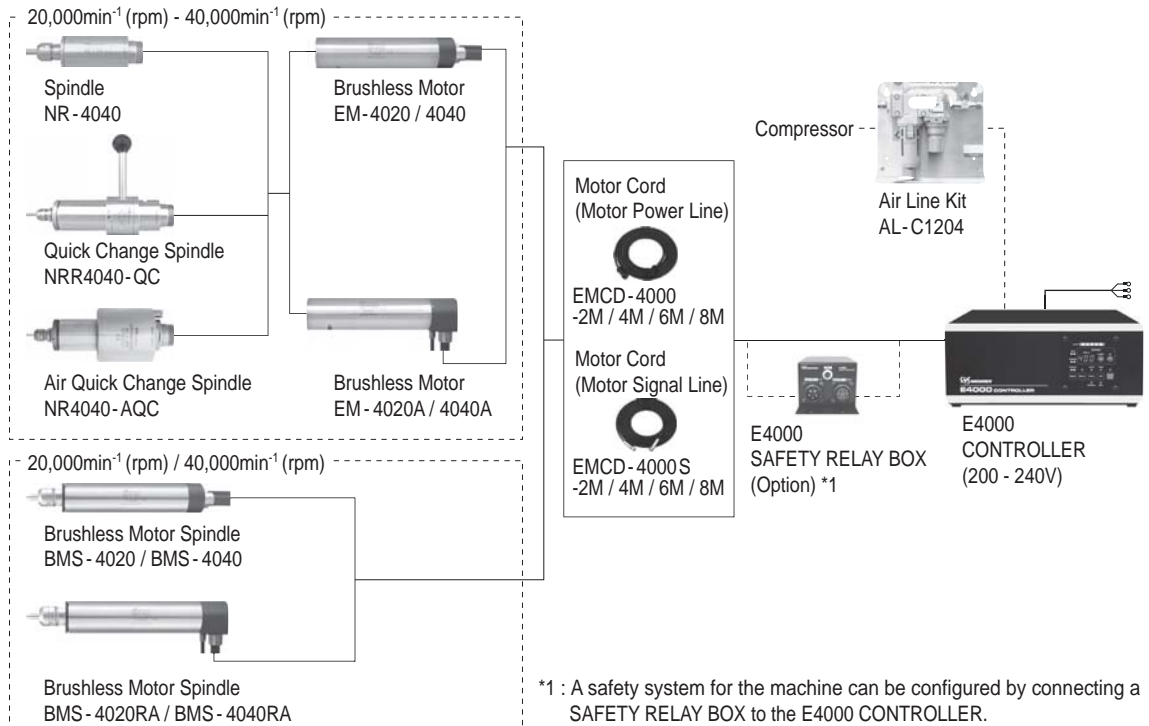

Fig. 3

## 8. TORQUE CHARACTERISTICS

(1)  $40,000\text{min}^{-1}$  (rpm) (BMS - 4040 / BMS - 4040RA / EM - 4040 / EM - 4040A)

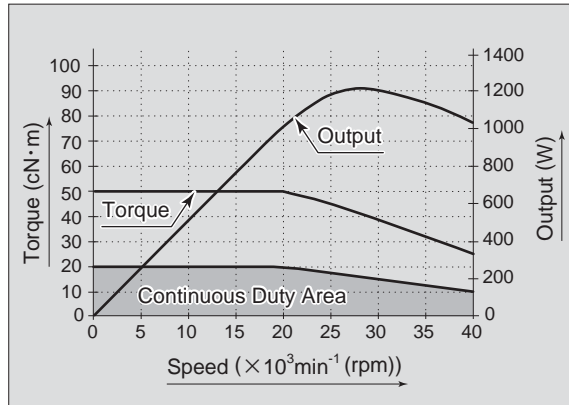

Fig. 4

(2)  $20,000\text{min}^{-1}$  (rpm) (BMS - 4020 / BMS - 4020RA / EM - 4020 / EM - 4020A)

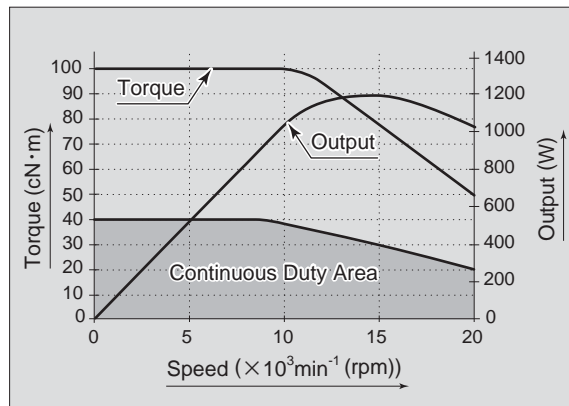

Fig. 5

## 9. PARTS NAMES

### 9 - 1 System



Fig. 6

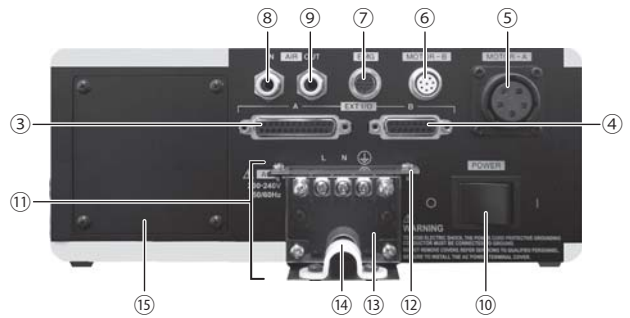

Fig. 7

- ① CONTROLLER
- ② Control Panel  
Refer to P62 " 9 - 2 Control Panel Details " section.
- ③ External Input / Output Connector A (EXT I / O - A)  
External Input / Output Connector A is for automatic control and monitoring of motor / spindle system. Refer to P71 " 16 - 1 (1) Details of External Input / Output Connector A Signals " section.  
Attach the provided Connector Cover A for safety and dust proofing, when not using External Input / Output connector A.
- ④ External Input / Output Connector B (EXT I / O - B)  
External Input / Output Connector B is for automatic monitoring of emergency conditions. P78 " 16 - 2 (1) Details of External Input / Output Connector B Signals " section.  
Attach the provided Connector Cover B for safety and dust proofing, when not using External Input / Output connector B.
- ⑤ MOTOR - A Connector (MOTOR - A) : For Motor Power Line.  
Connect the Motor Cord Plug (Motor Power Line) of the motor spindle.  
Attach the provided Connector Cap A for safety and dust proofing, when not using MOTOR - A Connector.
- ⑥ MOTOR - B Connector (MOTOR - B) : For Motor Signal Line.  
Connect the Motor Cord Plug (Motor Signal Line) of the motor spindle.  
Attach the provided Connector Cap B for safety and dust proofing, when not using MOTOR - B Connector.
- ⑦ EMG Connector (EMG) : Emergency Stop Cord Connection to the E4000 Safety Relay Box.  
Connects the Emergency Stop Cord from the CONTROLLER to the E4000 Safety Relay Box (Sold separately).  
Attach the provided Connector Cap EMG for safety and dust proofing, when not using EMG Connector.
- ⑧ Air Input Joint (AIR - IN)  
Supply clean, dry, regulated air for motor cooling. Regulate air to between 0.2 - 0.35MPa (29.0 - 50.8psi).  
When using the motor spindle for continuous use, supply the regulated air to CONTROLLER and set the air pressure to 0.35MPa (50.8psi). The air consumption is 100Nℓ / min when supplying air pressure of 0.35MPa (50.8psi). Refer to P67 " 13. AIR HOSE CONNECTION " section.

### ⚠ CAUTION

**If the air pressure is too low the CONTROLLER will not operate.**

- ⑨ Air Output Joint (AIR - OUT)  
Connect Air Hose to supply clean, dry, regulated air for motor and spindle cooling and purging. Refer to P67 " 13. AIR HOSE CONNECTION " section.
- ⑩ Main Power Switch (POWER)  
ON / OFF main power source. The designation " I " Indicates ON. The designation " O " Indicates OFF.

⑪ AC Power Input Terminal Block

The AC Power Input Terminal Block connects to the Power Cord terminals. Refer to P65 " 11. POWER CORD CONNECTION " section.

**⚠ DANGER**

- **Make sure the input power supply is OFF before wiring. If the incoming power supply is ON, it may cause risk that leads to death or serious injury by electric shock.**
- **After connecting the Power Cord, be sure to attach the Protective Covers A and B for safety, dust proofing and electric shock prevention. If the Protective Covers A and B are not attached to the CONTROLLER, it may lead to the risk of death or serious injury by electric shock.**

**⚠ WARNING**

- **Only use grounded power sources. Using a non-specified Power Cord, the risk of fire by over-heating of the cord is possible.**
- **Mis-wiring will cause damage to the CONTROLLER.**
- **Be sure to connect the ground wire to the earth ground. Insufficient grounding could cause an electric shock or malfunction.**
- **Tighten the Terminal Screw of the AC Power Input Terminal Block securely. Loose Terminal Screws to the AC Power Input Terminal Block will cause over-heating leading to damage and fire in the CONTROLLER.**

⑫ Protective Cover A / ⑬ Protective Cover B

The Protective Cover A and B attach to the AC Power Input Terminal Block, for safety dust proofing and prevention of electric shock.

**⚠ DANGER**

**Be sure to attach the Protective Covers A and B before use. Touching a power terminal connection by mistake may cause risk that leads to death or serious injury by electric shock.**

**⚠ CAUTION**

**Be sure to attach the Protective Covers A and B before use. Without the Protective Covers A and B, metal chips and other particles may stick to the AC Power Input Terminal Block causing electrical leakage and damage to the CONTROLLER.**

⑭ Securing Band

This band secures the Power Cord connected to the AC Power Input Terminal Block.

**⚠ CAUTION**

**After connecting the Power cord to the AC Power Input Terminal Block, make sure the Power Cord is secured in place by using the provided Securing Band.**

⑮ Plate

When changing the Control Panel from front to rear, remove the Plate from the rear of the CONTROLLER, and reinstall it on the front of the CONTROLLER where the Control Panel was removed from. When changing the Control Panel, refer to P68 " 14. CHANGING THE CONTROL PANEL " section.

## 9 - 2 Control Panel Details

### ⑩⑥ Digital Speed Indicator

Preset Speed, Actual Speed, Warning and Error Codes are displayed in 3 digits format.

When the motor is stopped the Preset Speed is displayed, when the motor is rotating the actual speed is displayed.

The display also displays the error codes when an error has occurred.

### ⑩⑦ Load Monitor LED (LOAD)

The motor spindle load is displayed by 6 LED's (3 Green, 2 Yellow and 1 Red). Continuous operation is possible with up to all 3 green LED's lit. If one of the yellow LED's is lit the motor spindle can only be run for a short time. Please refer to P83 " 17. PROTECT FUNCTION " section of this manual for allowable duration of high load operation. When any of the yellow or red LED's are lit the Warning LED (WARNING) will blink, if this condition is continued beyond the allowable interval the Error LED (ERROR) will light and the motor spindle will be shut down.

### ⑩⑧ Motor Speed Adjustment Button (SPEED ⬆️, ⬇️)

(Manual adjustable speed control is possible. ( ⬆️ (UP) or ⬇️ (DOWN). 1 digit is  $100\text{min}^{-1}$  (rpm).)

Speed Range

Motor Spindle : BMS - 4020 / BMS - 4020RA / EM - 4020 / EM - 4020A :  $1,000 - 20,000\text{min}^{-1}$  (rpm)

Motor Spindle : BMS - 4040 / BMS - 4040RA / EM - 4040 / EM - 4040A :  $1,000 - 40,000\text{min}^{-1}$  (rpm)

### ⑩⑨ START / STOP Button (START / STOP)

Starts and stops motor rotation.

### ⑩⑩ Rotation Direction Button (DIR)

Right hand rotation (FWD.) and left hand rotation (REV.) are as viewed with the cutting tool facing the operator. With the cutting tool facing the operator right hand rotation (FWD.) will be clockwise rotation.

### ⑩⑪ Control Button (CTRL)

This button will change the control mode to either MANUAL or AUTO.

MANUAL : Controlled by Control Panel.

AUTO : Controlled by External Input / Output Connector A from External Signal Source.

### ⑩⑫ Centering Mode Button ( $500\text{min}^{-1}$ (rpm))

$500\text{min}^{-1}$  (rpm) operation for centering.

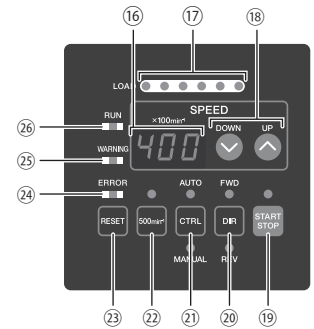

Fig. 8

## ⚠️ CAUTION

**Never attempt to cut while rotating in Centering Mode.**

### ⑩⑬ Error Reset Button (RESET)

This switch resets and allows restarting of the motor spindle after an error has been corrected.

If not Error Signal cannot be released by pressing the Error Reset Button (RESET), a situation has occurred that must be corrected before the Error Signal can be reset.

Some error codes will not allow the CONTROLLER to be reset.

### ⑩⑭ Error LED (ERROR)

When a serious problem with the system alarms is detected this LED illuminates.

The motor may shut down and the Digital Speed Indicator will displays an Error Code.

### ⑩⑮ Warning LED (WARNING)

The operating and working conditions of the system are constantly monitored and the Warning LED flashes when a hazardous condition has been detected. When a hazardous condition is detected the Warning LED flashes and the Digital Speed Indicator alternates between the Warning Code and the actual or preset speed, depending on whether or not the motor / spindle is rotating or not.

### ⑩⑯ Rotating LED (RUN)

When the motor is rotating, this LED will illuminate.



## 10. BRACKET AND RUBBER PAD INSTALLATION

### 10 - 1 Installation of the Brackets

#### ⚠ CAUTION

- If there is a possibility for the CONTROLLER from its mounting location, be sure to secure it with the Provided Brackets for safety.
- When mounting the Bracket, do not loosen any other screws other than the Mounting Screws that are meant to install the Bracket.

- Brackets are provided 4pcs.
- Bracket Mounting Screws are attached to the following locations of the CONTROLLER (Fig. 9).  
Bottom: 8pcs. Both sides: 4pcs. each side.
- The Bracket can be installed on the " (1) Bottom Mounting (Fig. 10, 11) " and " (2) Side Surface Mounting (Fig. 12, 13) " of the CONTROLLER.



Mounting Screw (8pcs.) attached to the bottom of the CONTROLLER.



Mounting Screw (each 4pcs.) attached to the side of the CONTROLLER.

Fig. 9

#### (1) Bottom Mounting

- ① Remove the Mounting Screws (8pcs.) from bottom of the CONTROLLER (Fig. 9).
- ② Install the Brackets (4pcs.) to the bottom of CONTROLLER by using removed Mounting Screws (8pcs.) (Fig. 10).
- ③ Attach the CONTROLLER (Bracket's Slotted Area) to the machine using the mounting screws (**8 pcs. not included / provided by the end-user.**) (Fig. 11).

\*Mounting screws used to attach the CONTROLLER on the machine, not included / provided by the end-user.

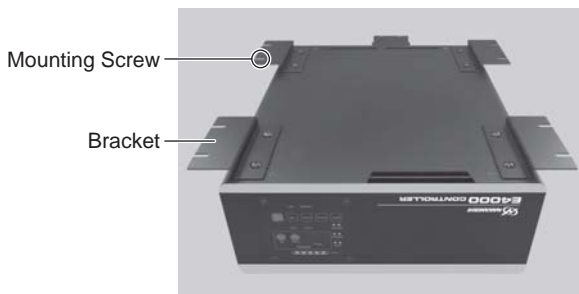

Fig. 10

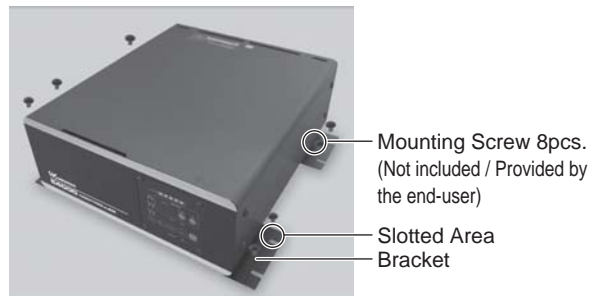

Fig. 11

## (2) Side Surface Mounting

- ① Remove the Mounting Screws (4pcs.) from side of the CONTROLLER (Fig. 9).
- ② Install the Brackets (2pcs.) to the side of CONTROLLER by using removed Mounting Screws (4pcs.) (Fig. 12).
- ③ **Attach the CONTROLLER (Bracket's Slotted Area) to the machine using the mounting screws (8 pcs. not included / provided by the end-user). (Fig. 13).**  
\*Mounting screws used to attach the CONTROLLER on the machine, not included / provided by the end-user.
- ④ If " Side Surface Mounting " of the CONTROLLER is required.  
If the CONTROLLER is installed using its side surface, the Control Panel can be rotated 90-degrees from the original position. To rotate, remove the 4 Control Panel Mounting Screw attached to Control Panel. Change position of the Control panel and re-install the 4 Control Panel Mounting Screws.

### ⚠ CAUTION

Make sure the input power supply is OFF before rotating the mounting direction of the Control Panel. If the incoming power supply is ON, electric shock or damage to the CONTROLLER may result.



Fig. 12

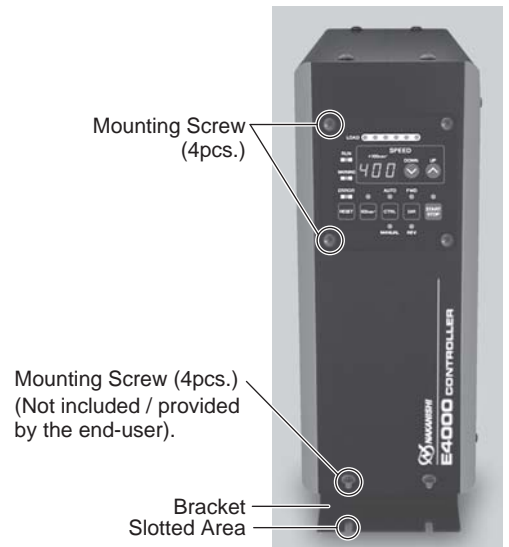

Fig. 13 Control Panel vertical position.

## 10 - 2 Installation of the Rubber Pad

If the CONTROLLER is installed in a vertical position, install the Rubber Pads to the CONTROLLER as shown in Fig. 14.



Fig. 14

## 11. POWER CORD CONNECTION

### ⚠ DANGER

- NAKANISHI warns all end-users not to remove the CONTROLLER's Protective Covers A and B while the Control Power is ON, or there is power to the main power cord. Disconnect the main power from its power source before removing the Protective Covers A and B. Not following these instructions may lead to serious injury or death due to electric shock.
- After connecting the Power Cord, be sure to attach the Protective Covers A and B safety, dust proofing and electric shock prevention. If the Protective Cover A and B are not attached to the CONTROLLER, it may lead to the risk of death or serious injury by electric shock.

### ⚠ WARNING

- Only use grounded power sources. Using a non-specified Power Cord, the risk of fire by over-heating of the cord is possible.
- Mis-wiring will cause damage to the CONTROLLER.
- Be sure to connect the ground wire to the earth ground. Insufficient grounding could cause an electric shock or malfunction.
- Tighten the Terminal Screw of the AC Power Input Terminal Block securely. Loose Terminal Screws to the AC Power Input Terminal Block will cause over-heating leading to damage and fire in the CONTROLLER.

- (1) Loosen the mounting screws located on Protective Covers A , B and the Securing Band. Remove Protective Covers A , B and the Securing Band from the rear of the CONTROLLER.
- (2) The round terminal lugs are attached to the one side of the Power Cord. Remove the Terminal Screw from the AC Power Input Terminal Block. Make sure to connect the round terminal to the AC Power Input Terminal Block securely. (Table 2, Fig. 15)
- (3) After connecting the Terminal Screw to the AC Power Input Terminal Block, be sure to securely tighten the Terminal Screws.
- (4) Re-Attach the Protective Covers A and B to the AC Power Input Terminal Block by using the original mounting screws.
- (5) Secure the Power Cord using the Securing Band and Mounting Screw.

Table. 2

Cord Color	AC Power Input Terminal Block connection position
Black	L
White	N
Green / Yellow (For Ground)	⊕

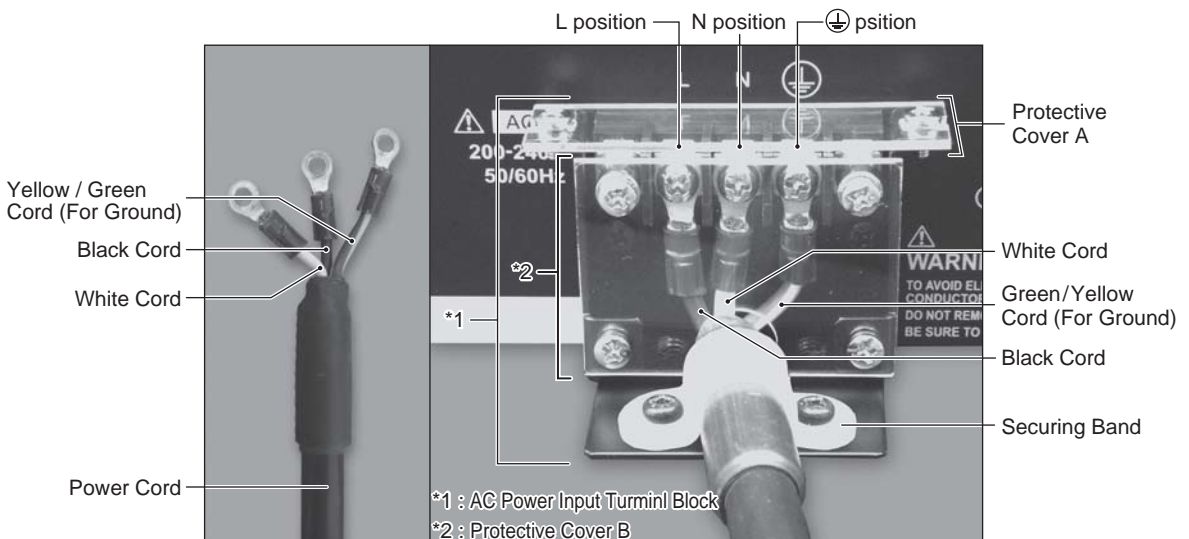

Fig.15

## 12. MOTOR CORD CONNECTION

### ⚠ CAUTION

- Before connecting to the Motor Cord Plug (For Power Line / Signal Line), make sure the Main Power Switch is turned OFF. If the Main Power Switch is turned ON while connecting the Motor Cord Plug (For Power Line / Signal Line), damage may occur to the CONTROLLER .
- Install the protective cover (Protective Cover etc.) to prevent damage or contamination to the Motor Cord Plug (For Power Line / Signal Line) when not in use.
- After connecting the Motor Cord (For Power Line / Signal Line), do not make any sharp bends to the Motor Cord (For Power Line / Signal Line).

- (1) Ensure the Alignment Pin of the Motor Cord Plug (Power Line) is located upward (12 o'clock).
- (2) Carefully insert the Alignment Pin of Motor Cord Plug (Power Line) into the Alignment Hole (MOTOR - A Connector) of the rear of the CONTROLLER and push straight. Tighten the Fixing Ring of the Motor Cord Plug (Power Line). (Fig. 16, 18)
- (3) Ensure the Alignment Pin of the Motor Cord Plug (Signal line) is located upward (12 o'clock).
- (4) Carefully insert the Alignment Hole of Motor Cord Plug (Signal line) into the Alignment Pin (MOTOR - B Connector) of the rear of the CONTROLLER and push straight. Tighten the Fixing Ring of the Motor Cord Plug (Signal line). (Fig. 17, 18)

Motor Cord Plug (For Motor Power Line)

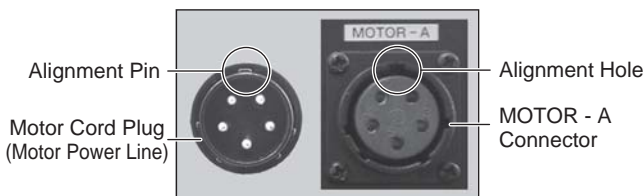

Fig. 16

Motor Cord Plug (For Motor Signal Line)

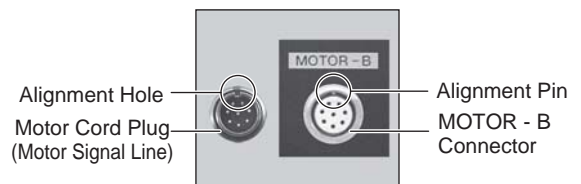

Fig. 17

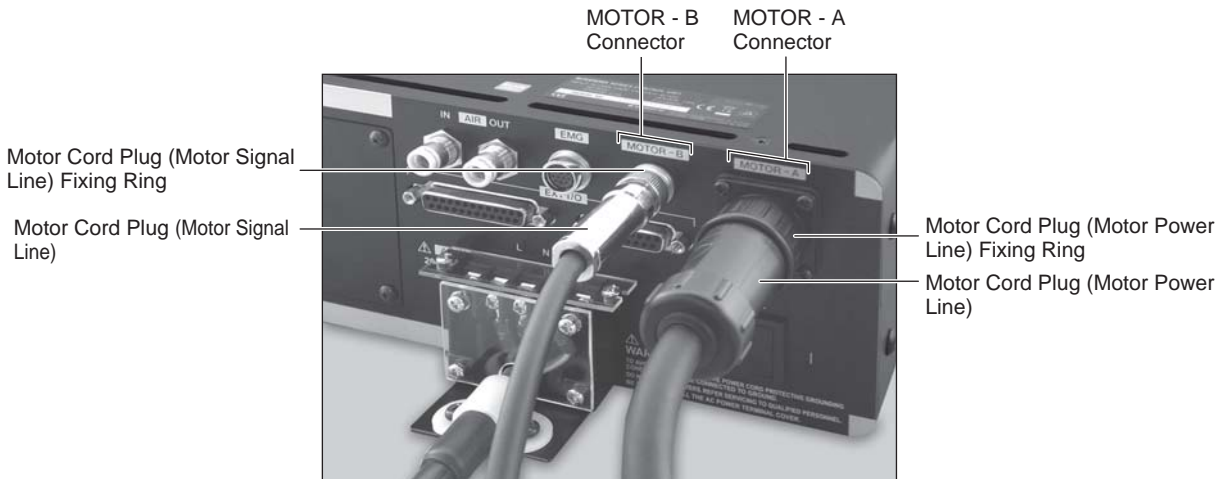

Fig. 18

## 13. AIR HOSE CONNECTION

### **⚠ CAUTION**

When not using NAKANISHI Air Line Kit, make sure that the incoming air supply is dry, clean and properly regulated.

- (1) Insert the provided  $\phi 6\text{mm}$  Air Hose (2m) with Filter (CONTROLLER's standard accessories) from the Air Line Kit into the Air Input Joint on the rear of the CONTROLLER .
- (2) Insert one end of the provided  $\phi 6\text{mm}$  cooling Air Hose (Motor Cord's standard accessories) into the back of the motor.
- (3) Insert the other end of the  $\phi 6\text{mm}$  cooling Air Hose (Motor Cord's standard accessories) into the Air Output Joint on the rear of the CONTROLLER .
- (4) Regulate air pressure between 0.2 - 0.35MPa (29.0 - 50.8psi).

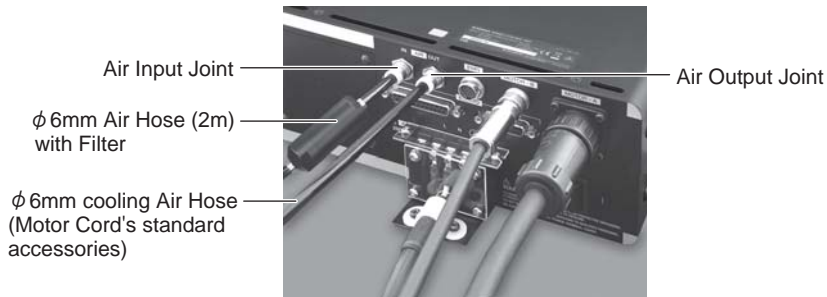

Fig. 19

### **⚠ CAUTION**

- The Air input joint, is designed to accept cooling air between 0.2 - 0.35MPa (29.0 - 50.8psi). If the air pressure is too low, the CONTROLLER will not operate and an Error code will be generated. Set the air pressure 0.35MPa (50.8psi) when using the motor spindle for continuous use.
- The cooling air also provides air purge protection to the motor spindle. If the Main Power Switch is turned OFF, the cooling air will continue to flow.
- Do not make any sharp bends in the air hose, or pull on the hose as this can cause the hose to break, cut off the air supply or weaken the hose over time resulting in deterioration of the motor and spindle.
- Never supply over regulated air pressure. There is a possibility to damage to the air detection sensor inside the CONTROLLER.
- The air detect function within the CONTROLLER detects air input supply only. If the Air Out hose is damaged from the CONTROLLER, it will not be able to detect the lack of cooling and purging air to the motor spindle.

## 14. CHANGING THE CONTROL PANEL

### WARNING

Make sure the input power supply is OFF before rotating the direction of setting Control Panel. If the incoming power supply is ON, it may cause electric shock or damage to the CONTROLLER.

The position of the Control Panel can be changed from the front to rear of the CONTROLLER.

- (1) Remove the 4 screws that affix the Control Panel and pull the Control Panel gently from the CONTROLLER (Fig. 20).

Remove the connector from rear of the Control Panel (Fig. 20).

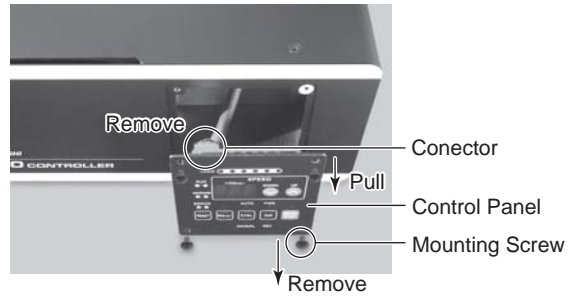

Fig. 20

- (2) Remove the screw from the Plate and pull the Plate from the CONTROLLER (Fig. 21).

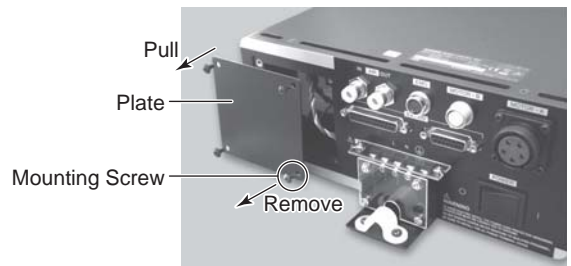

Fig. 21

- (3) Connect the connector inside the CONTROLLER to the connector of the rear of the Control Panel (Fig. 22).
- (4) Re-attach the Control Panel using the 4 mounting screws (Fig. 22).

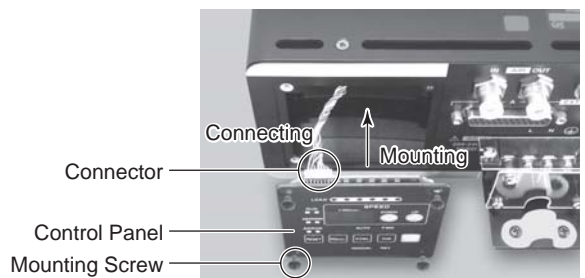

Fig. 22

- (5) Mounting the Plate using the 4 mounting screws. (Fig. 23).

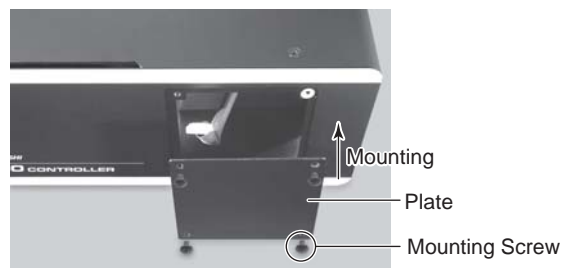

Fig. 23

## 15. OPERATION PROCEDURES

### 15 - 1 Selecting Control Mode (MANUAL / AUTO). (Select the control button (CTRL) ⑳ of the Fig. 24.)

- (1) Using the CONTROL (CTRL) Button you can select between Manual (Front panel control) or Auto (External Signal Source) modes. External Signal Source can be used to control Motor Start / Stop, Rotation Direction, Motor Speed etc. from an external control source (CNC).
- (2) When operating with the CONTROLLER Control Panel, push the Control Button (CTRL) of Fig. 24 and select MANUAL. The Manual LED will illuminate.

When operating from an External Signal Source, push the Control Button (CTRL) of Fig. 24 and select AUTO. The AUTO LED will illuminate.

MANUAL Mode : Controlled by Control Panel .

AUTO Mode : Controlled by Input / Output Connector A from an External Signal Source

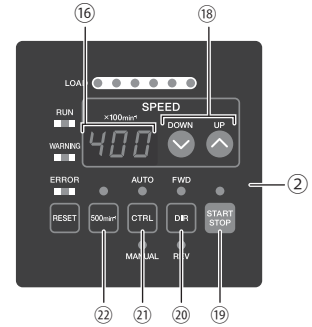

Fig. 24

### 15 - 2 Setting Motor Start / Stop (START / STOP), Motor Rotating Direction (FWD / REV), Motor Speed (SPEED)

#### 15 - 2 - 1 Manual Mode Operation

- (1) Set Motor Rotating Direction (Set the Rotation Direction Button (DIR) ⑳ of the Fig. 24.)  
Push the Rotation Direction Button (DIR).  
Select FWD. : Right hand rotation.  
Select REV. : Left hand rotation.  
With the cutting tool facing the operator right hand rotation (FWD.) will be clockwise rotation.
- (2) Set 500 min<sup>-1</sup> (rpm) Centering Rotation (Set the 500 min<sup>-1</sup> Button ㉒ of the Fig. 24.)

#### ⚠ CAUTION

**Never attempt to cut while rotating in Centering Mode.**

- When carrying out centering, press the 500 min<sup>-1</sup> Button. The rotation speed is set to 500min<sup>-1</sup> (rpm).
- (3) Motor Start / Stop (Motor Start / Stop by pushing the Start / Stop Button (START / STOP) ⑲ of the Fig. 24.)  
The motor spindle will start and the LED will illuminate.  
Push Start / Stop Button (START / STOP) again and the motor will stop and the LED will go out.
  - (4) Setting Motor Speed (Set the Motor Speed Adjustment Button (SPEED Ⓐ , Ⓑ ) ⑱ of the Fig. 24.)  
Set the speed by pushing the Motor Speed Adjustment Button (SPEED Ⓐ , Ⓑ ).  
Speed Range  
Motor Spindle BMS - 4020 / BMS - 4020RA / EM - 4020 / EM - 4020A : 1,000 - 20,000min<sup>-1</sup> (rpm)  
Motor Spindle BMS - 4040 / BMS - 4040RA / EM - 4040 / EM - 4040A : 1,000 - 40,000min<sup>-1</sup> (rpm)  
The motor speed is displayed in 100 min<sup>-1</sup> (rpm) increments. 200 equals 20,000 min<sup>-1</sup> (rpm).

#### 15 - 2 - 2 Auto Mode Operation

Use the External Input / Output Connector A to input control signals to the CONTROLLER.

- (1) Set motor Rotating Direction  
Input the " Rotating Direction Setting " to Pin No. 2 : DIR\_IN  
Right hand rotation is " OFF " (Open) (" FWD ", LED will illuminate).  
Left hand rotation is " ON " (Closed) (" REV ", LED will illuminate).  
With the cutting tool facing the operator right hand rotation (FWD.) will be clockwise rotation.
- (2) Set 500 min<sup>-1</sup> (rpm) Centering Rotation

#### ⚠ CAUTION

**Never attempt to cut while rotating in Centering Mode.**

Input the " Rotates Motor at ' Centering speed ' to Pin No. 16 : 500 min<sup>-1</sup> (rpm). 500 min<sup>-1</sup> LED will illuminate.  
When using the Centering Mode: " ON " (' Closed ')



### (3) Motor Start / Stop

Input the Motor Start Signal (Pin No. 14: START).

Motor rotating is " ON " (Close). When startup, START / STOP LED of the CONTROLLER will light and motor will rotate.

### (4) Setting the Motor Speed

Motor Speed Range is 1,000 - 40,000 min<sup>-1</sup> (rpm). Maximum motor speed depends on motor and spindle model.

Setting parameter  $P2$  to  $Gn$  will allow the motor speed to be adjusted in Auto Mode using the Motor Speed Adjustment Button (SPEED  $\blacktriangle$ ,  $\blacktriangledown$ )  $\textcircled{18}$  of the Fig. 24.

(Refer to P91 " 18 - 4  $\textcircled{2}$   $P2$  Setting AUTO Mode for Motor Speed Control "section.)

#### Speed Range

Motor Spindle BMS - 4020 / BMS - 4020RA / EM - 4020 / EM - 4020A : 1,000 - 20,000min<sup>-1</sup> (rpm)

Motor Spindle BMS - 4040 / BMS - 4040RA / EM - 4040 / EM - 4040A : 1,000 - 40,000min<sup>-1</sup> (rpm)

Rotational speed can be set by the using one of the following 3 methods. The Rotation Speed is setting to an analog Signal before shipment.

#### ① Setting by Analog signal

Input the " Motor Speed Control Voltage " to Pin No. 23 : VR.

Refer to P76 " 15 - 1 (3)  $\textcircled{4}$  Motor Speed Control Signal " section.

#### ② Setting by Pulse Signal

(Set parameter  $P5$  of the CONTROLLER. Refer to P92 " 18 - 4  $\textcircled{5}$   $P5$  Selection of External Speed Control Mode " section.)

Input the " Count Pulse Signal for Setting Motor Speed " (Pin No. 3 : CNT\_IN) and " UP / DOWN Signal for Setting Motor Speed " (Pin No. 15 : UD\_IN). One pulse will increase or decrease 100min<sup>-1</sup> (rpm) of Spindle Speed counted on the leading edge of the signal.

" UP / DOWN Signal " for Setting Motor Speed is " ON " (Close) : increase speed, " OFF " (Open) : decrease speed.

#### ③ Set by the Speed Point Signal

(Set parameter  $P5$ ). (Refer to P92 " 18 - 4  $\textcircled{5}$   $P5$  Selection of External Speed Control Mode " section.)

Select the Speed Point  $G1$  -  $G4$  by combination of " Speed Point Select 0 " (Pin No. 17 : SEL0) and " Speed Point Select 1 " (Pin No. 5 : SEL1).

Set the Motor Rotation Speed. Select the Speed Point  $G1$  -  $G4$  by combination in Table. 3.

Table. 3

Speed Point	SEL1 (Pin No. 5)	SEL0 (Pin No. 17)
$G1$	OFF (Open)	OFF (Open)
$G2$	OFF (Open)	ON (Closed)
$G3$	ON (Closed)	OFF (Open)
$G4$	ON (Closed)	ON (Closed)

### (5) Resetting System after Error Codes

Releasing Error Code by The " Error Release " (Pin No. 4 : RESET). Switch the signal on Pin No. 4 (RESET) of External Input / Output Connector A OFF (Open) → ON (Closed) → OFF (Open).

Error Signal will not be released until cause of the error has been removed.

Refer to P84 " 17 - 3 Resetting System after Error Codes " section.



## 16. EXTERNAL INPUT / OUTPUT CONNECTOR

### 16 - 1 External Input / Output Connector A

(1) Details of External Input / Output Connector A Signals

#### ⚠ WARNING

- **DO NOT connect any circuit other than SELV (DC+24V) (Safety Extra Low Voltage) to the External Input / Output Connector A of the CONTROLLER. This will cause I / O board damage in the CONTROLLER.**
- **Do not supply over voltage or over current into the input / output circuit. Always install a LOAD (resistor) to the output circuit to eliminate the chance of damage to the CONTROLLER.**

#### ⚠ CAUTION

**External Input / Output Connector A DOES NOT use Pins No. 9 and No. 22. If pin No. 9 and No. 22 are connected, the CONTROLLER will be damage.**

Table. 4

Pin No.	Code	Function	Input / Output	Description	
1	COM_1	External Power source for External input	Input	DC 0V or DC+24V	Power source to be used for External Inputs Signals. (not included / prepared by the end-user)
2	DIR_IN	Rotating Direction Setting	Input	OFF (Open) : FWD. ON (Closed) : REV.	Controls the rotational direction of the motor spindle. Setting parameter $P5$ , can start with reverse rotation. (Refer to P93 " 18 - 4 ⑥ $P5$ Selection of External Motor Start Signal Control Mode " section.)
3	CNT_IN	Count Pulse Signal for Setting Motor Speed	Input	OFF (Open) → ON (Closed)	One pulse will increase or decrease 100min <sup>-1</sup> (rpm) in Spindle Speed depending on parameter $P5$ setting. (Refer to P92 " 18 - 4 ⑤ $P5$ Selection of External Speed Control Mode " section.)
4	RESET	Error Release	Input	ON (Closed) → OFF (Open)	Error Code can be released and the system restarted by toggling this signal OFF and ON. Error will not be released until cause of the error has been removed.
5	SEL1	Speed Point Select 1	Input	OFF (Open) ON (Closed)	Speed Point ( $U1$ - $U4$ ) can be Selected by SEL0 and SEL1 signal combination. P70 " 15 - 2 - 2 (4) ③ Set by the Speed Point Signal Table 3 " section. Need to set parameter $P5$ . (Refer to P92 " 18 - 4 ⑤ $P5$ Selection of External Speed Control Mode " section.)
6	RUN	Rotating	Output	OFF (Open) : Stop ON (Closed) : Rotating	Output shows that the motor is rotating.
7	DIR_OUT	Rotating Direction	Output	OFF (Open) : FWD. ON (Closed) : REV.	Output shows the direction of the Motor is rotating.

Pin No.	Code	Function	Input / Output	Description	
8	ERR	Error	Output	OFF (Open) : Error ON (Closed) : Normal	Output shows that error has occurred. Error code will be displayed on Digital Speed Indicator. When setting parameter $P1$ , Error Output Mode can be changed. (Refer to P90 " 18 - 4 ① $P1$ Setting of Error Output Mode " section.)
9	Not used	—	—	—	<b>*Note : Never use pin labeled " NOT USED "</b>
10	GND	Internal GND for Motor Speed Control Voltage	Output	Internal CONTROLLER GND	This GND will be used for " Motor Speed Control Voltage (VR) ". Output DC+10V
11	Vcc	Internal Power Source for Motor Speed Control Voltage	Output	Internal Power : DC+10V	Internal Power Source for " Motor Speed Control Voltage (VR) ".
12	MOTOR_I	Motor Current Monitor	Output	$0V \leq \text{MOTOR\_I} \leq 10V$ DC 0V : 0Amp DC+10V : 20Amp	Output Motor Current Monitor with Analog Monitor Voltage. 2Amp / 1V. Max. 20Amp.
13	GND	Internal GND for Analog Monitor	Output	Internal CONTROLLER GND	This GND will be used for analog monitor. (MOTOR_I, SPEED_V, and LOAD).
14	START	Rotate Command	Input	OFF (Open) : Stop ON (Closed) : Start	Motor Start and Motor Stop Signal Setting parameter $P5$ , can start with forward rotation. (Refer to P93 " 18 - 4 ⑥ $P5$ Selection of External Motor Start Signal Control Mode " section.)
15	UD_IN	UP / DOWN Signal for Setting Motor Speed	Input	OFF (Open) : Speed Down ON (Closed) : Speed Up	This signal is for increasing and decreasing the desired speed by the use of a Pulse Signal. Whether it increases or decreases speed is determined by CNT_IN. It is required that parameter $P5$ . (Refer to P92 " 18 - 4 ⑤ $P5$ Selection of External Speed Control Mode " section.)
16	500min <sup>-1</sup> (rpm)	Rotates Motor at " Centering " speed	Input	OFF (Open) : Normal Operation ON (Closed) : 500min <sup>-1</sup> (rpm)	Set motor rotation speed is 500 min <sup>-1</sup> (rpm). Use the Centering Mode.
17	SEL0	Speed Point Select 0	Input	OFF (Open) ON (Closed)	Speed Point ( $U1$ - $U4$ ) can be Selected using a SEL0 and SEL1 signal combination. P70 " 15 - 2 - 2 (4) ③ Set by the Speed Point Signal Table 3 " section. Need to set parameter $P5$ . (Refer to P92 " 18 - 4 ⑤ $P5$ Selection of External Speed Control Mode " section.)

Pin No.	Code	Function	Input / Output	Description	
18	COM_2	External Power Source for External Output	Input	DC 0V or DC+24V	Power source to be used for External outputs. (Not included / prepared by the end-user)
19	PULSE	Rotating Pulse	Output	1 pulse / rotation	Output 1 pulse / rotation 1 revolution of the motor generates one pulse. Duty 50%.
20	WARNING	WARNING	Output	OFF (Open) : Normal Operation ON (Closed) : Warning	Output shows that warning has occurred. Warning code will be displayed on Digital Speed Indicator.
21	COIN	Speed Achievement	Output	OFF (Open) : Set speed not achieved ON (Closed) : Set speed achieved	Shows that the Motor has achieved more than 90% of the set speed.
22	Not used	—	—	—	<b>*Note : Never use pin labeled " NOT USED "</b>
23	VR	Motor Speed Control Voltage	Input	$0V \leq VR \leq 10V$	Analog Voltage (Set the Motor Rotation Speed by $0V \leq VR \leq 10V$ ) BMS - 4040 / BMS - 4040RA EM - 4040 / EM - 4040A : $\text{Motor Rotation Speed (min}^{-1} \text{ (rpm))} = \frac{\text{Motor Speed Control Voltage (VR)}}{2} \times 10,000$ BMS - 4020 / BMS - 4020RA EM - 4020 / EM - 4020A : $\text{Motor Rotation Speed (min}^{-1} \text{ (rpm))} = \frac{\text{Motor Speed Control Voltage (VR)}}{4} \times 10,000$ Refer to Fig.31 regarding the relationship between motor speed and Control Signal.
24	LOAD	Torque Load Monitor	Output	$0V \leq \text{LOAD} \leq 10V$	Shows that the torque being applied to the analog motor. 20% / V 100% (rating) / DC+5V Torque Load Monitor (%) = Torque Load Monitor Voltage X 20 Torque Load Monitor : 0 - 200% ( $0V \leq \text{LOAD} \leq 10V$ )
25	SPEED_V	Rotating Speed Analog Monitor Voltage	Output	$0V \leq \text{SPEED\_V} \leq 10V$	Output the rotation speed of rotating motor with Analog Monitor Voltage. $10,000\text{min}^{-1} \text{ (rpm)} / V$

(2) Input / Output Diagram

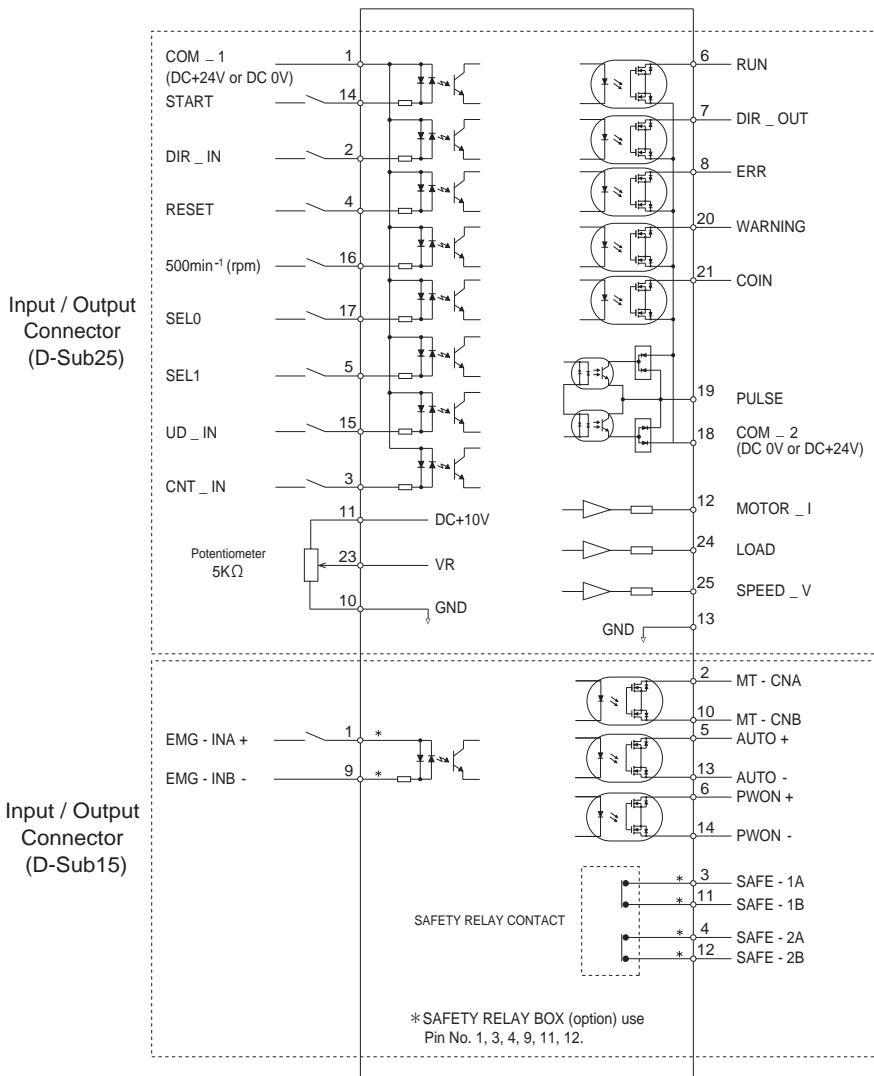

Fig. 25

(3) Input / Output Signal

① Input Signal

There are 8 different input signals : " Rotate Command (START) ", " Rotating Direction Setting (DIR\_IN) ", " Rotates Motor at ' Centering ' Rotation Speed (500min<sup>-1</sup> (rpm)) ", " Error Release (RESET) ", " Count Pulse Signal for Setting Motor Speed (CNT\_IN) ", " UP / DOWN Signal for Setting Motor Speed (UD\_IN) ", " Speed Point Select 0 (SEL0) " and " Speed Point Select 1 (SEL1)" . These signals are DC+24V signals from an external signal source.

Please use a separate power source that is capable of supplying DC+24V ± 10%, 100mA.

**CAUTION**

**Do not use a power supply of more than DC+24V. This will cause damage to the CONTROLLERS I / O Board.**

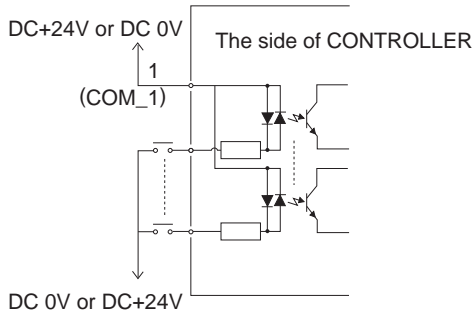

Fig. 26

② Output Signal I

There are 5 separate output signals: " Rotating (RUN) ", " Rotating Direction (DIR\_OUT) ", " Error (ERR) ", " Warning (WARNING) " and " Speed Achievement (COIN) ". These signals are MOSS Relay Contact Connections. The output current can be connected to either sinking or sourcing.

Voltage and Current Specifications

• Applied Voltage (V) ≤ DC+30V

• Working Current (I<sub>p</sub>) ≤ 100mA

Refer to Fig. 27 for connections.

**CAUTION**

**Never supply more that 100mA of current to the input / output circuit. It is highly recommended to add a LOAD (resistor) to the output circuit. Over Current Will Cause Damage to the CONTROLLER.**

Use an external power source for output circuits. It is recommended to use the same DC+24V power source used for input signals. Please refer to Fig. 27 for connections.

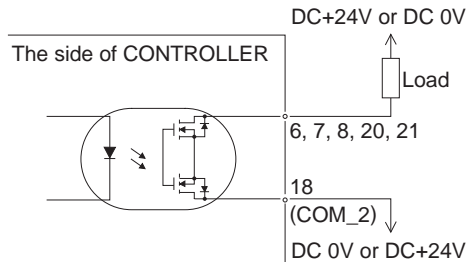

Fig. 27

③ Output Signal II

Refer to Fig. 28 regarding the Output Signal of the " Rotating Pulse (Pulse) ". The output signal can be connected for either sinking or sourcing.

Voltage and Current Specifications

- Applied Voltage (V)  $\leq$  DC+30V
- Working Current (Ip)  $\leq$  50mA

**CAUTION**

**Do not send excess current into the input / output circuit. Verify the working-current will is less than 50mA after connected the LOAD (resistor) of the output circuit. EXCESS CURRENT WILL CAUSE DAMAGE TO THE CONTROLLER.**

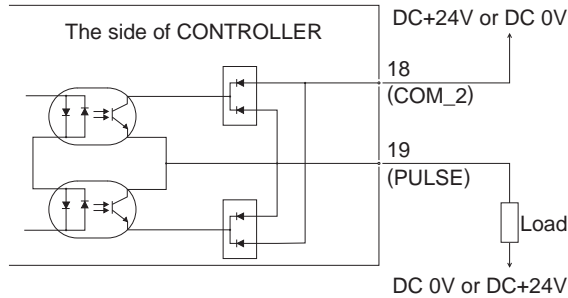

Fig. 28

④ Motor Speed Control Signal

Rotation Speed can be selected by, applying analog voltage to the " Motor Speed Control Voltage (VR) ". Refer to Fig. 29, 30 for connections. Refer to Fig. 31 for the relationship between Motor Speed and " Motor Speed Control Voltage (VR) ".

**CAUTION**

**When applying the DC 0V to DC+10V, never input more than DC+10V to the CONTROLLER (Fig. 30). This will cause serious damage to the I / O Board in the CONTROLLER.**

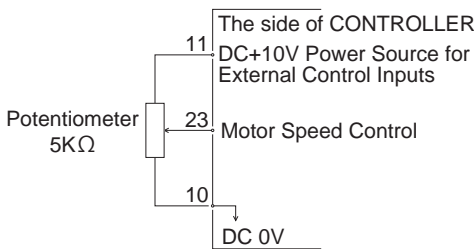

Fig. 29

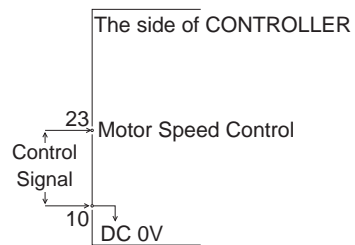

Fig. 30

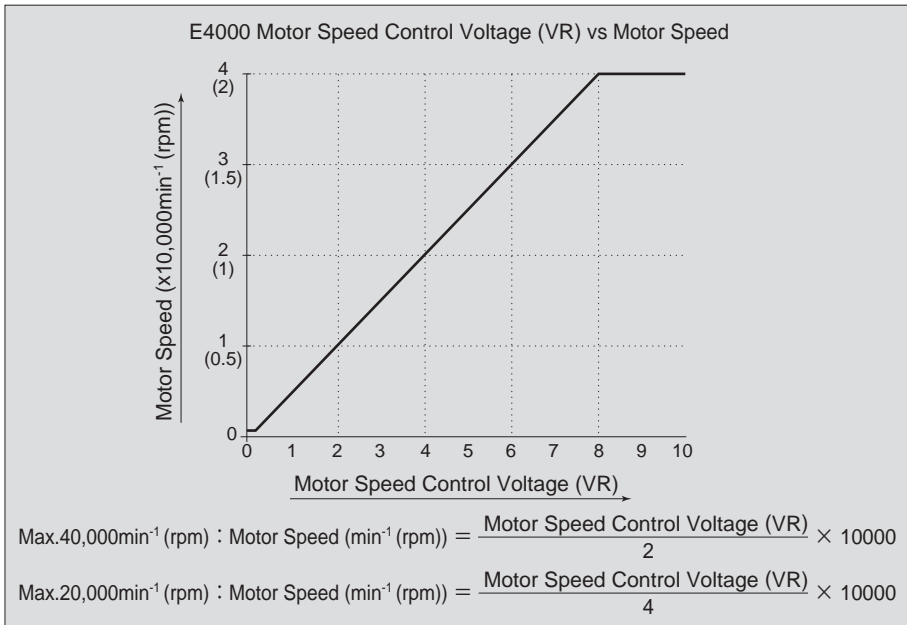

Fig. 31

⑤ Analog Monitor Signals

There are 3 separate monitoring signals : " Motor Current Monitor (MOTOR\_I) ", " Torque Load Monitor (LOAD) ", and " Rotating Speed Analog Monitor Voltage (SPEED\_V) ". Please refer to Fig. 32 for connections.

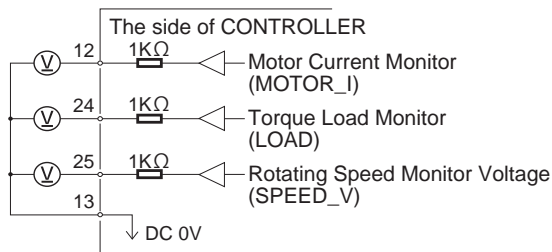

Fig. 32

## 16 - 2 External Input / Output Connector B

(1) Details of External Input / Output Connector B Signals

### WARNING

- **DO NOT CONNECT** any circuit other than SELV (DC+24V) (Safety Extra Low Voltage) to the External Input / Output Connector B of the CONTROLLER, this will cause I / O board damage in the CONTROLLER.
- **Do not supply over voltage or over current** into the input / output circuit. Always install a **LOAD (resistor)** to the output circuit to eliminate the chance of damage to the CONTROLLER.

### CAUTION

**External Input / Output Connector B DOES NOT use Pins No. 7, No. 8 and No. 15. If Pins No. 7, No. 8 and No. 15 are connected, the CONTROLLER will be damage.**

Table. 5

Pin No.	Code	Function	Input / Output	Description	
1	EMG - INA	Emergency Stop A	Input	External Power Source input for Emergency Stop Signal or Emergency Stop Signal OFF (Open)	External Power Source input for Emergency Stop Signal or Emergency Stop Signal. Normal Operation ON (Closed), Emergency OFF (Open). This signal is active only when connecting the Safety Relay Box (Sold separately) to the CONTROLLER.
2	MT - CNA	Motor Connect Contact A	Output	Continuity, OFF (Open), between Pin No. 2 and Pin No. 10 the motor is connected	When there is continuity, OFF, between Pin No. 2 and Pin No. 10 and the selected motor is connected, if no continuity is present, the motor is disconnected or the Motor Cord is broken.
3	SAFE - 1A	Safety Relay Contact 1A	Output	Pin No. 3 and Pin No. 11 continuity ON (Closed) Safety Relay is OFF	When there is continuity between Pin No. 3 and Pin No. 11 ON (Closed) Safety Relay is OFF (System Stopped), no continuity Safety Relay is OFF (Open) Normal Operation.
4	SAFE - 2A	Safety Relay Contact 2A	Output	Pin No. 4 and Pin No. 12 continuity ON (Closed) Safety Relay is OFF	When there is continuity between Pin No. 4 and Pin No. 12 ON (Closed), the Safety Relay is OFF (System Stopped), no continuity Safety Relay is OFF (Open) is Normal Operation.
5	AUTO +	Control Mode AUTO Signal (+)	Output	Control Mode AUTO Pin No. 5 and Pin No. 13 are ON (Closed)	When Control Mode AUTO is being used, the Pin No. 5 and Pin No. 13 are ON (Closed).
6	PWON +	CONTROLLER Power Source Monitor (+)	Output	ON (Closed) : Main Power Supply is connected. OFF (Open) : Main Power Supply is disconnected	If the Main Power Switch is ON, Pin No. 6 and Pin No. 14 are ON (Closed).



Pin No.	Code	Function	Input / Output	Description	
7	Not Used	—	—	—	<b>*Note : Never use pin labeled " NOT USED "</b>
8	Not Used	—	—	—	<b>*Note : Never use pin labeled " NOT USED "</b>
9	EMG - INB	Emergency Stop B	Input	External Power Source input for Emergency Stop Signal or Emergency Stop Signal OFF (Open)	External Power Source input for Emergency Stop Signal or Emergency Stop Signal OFF (Open). Normal Operation ON (Closed), Emergency OFF (Open). This signal is active only when connecting the Safety Relay Box (Sold separately) to the CONTROLLER.
10	MT - CNB	Motor Connect Contact B	Output	Continuity, OFF (Open), between Pin No. 2 and Pin No. 10 the motor is connected	When there is continuity, OFF, between Pin No. 2 and Pin No. 10, the selected motor is connected, if no continuity the motor is disconnected or the motor cord is broken.
11	SAFE - 1B	Safety Relay Contact 1B	Output	Pin No. 3 and Pin No. 11 continuity ON (Closed) Safety Relay is OFF	When there is continuity between Pin No. 3 and Pin No. 11 ON (Closed) Safety Relay is OFF (System Stopped). If there is no continuity Safety Relay is OFF (Open) Normal Operation.
12	SAFE - 2B	Safety Relay Contact 2B	Output	Pin No. 4 and Pin No. 12 continuity ON (Closed) Safety Relay is OFF	When there is continuity between Pin No. 4 and Pin No. 12 ON (Closed) the Safety Relay is OFF (System Stopped). If there is no continuity, Safety Relay is OFF (Open) Normal Operation.
13	AUTO -	Control Mode AUTO Signal (-)	Output	Control Mode AUTO Pin No. 5 and Pin No. 13 are ON (Closed)	When Control Mode AUTO is being used, Pin No. 5 and Pin No. 13 are ON (Closed).
14	PWON -	CONTROLLER Power Source Monitor (-)	Output	ON (Closed) : Main Power Supply is connected OFF (Open) : Main Power Supply is disconnected	If the Main Power Switch is ON, Pin No. 6 and Pin No. 14 are ON (Closed).
15	Not Used	—	—	—	<b>*Note : Never use pin labeled " NOT USED "</b>

## (2) Input / Output Signals

### ① Output Signal (Pin No. 2 - No. 10, No. 5 - No. 13, No. 6 - No. 14)

There are 3 kinds of output signals : " Motor Signal Connect Contact (MT - CN) ", " Control Mode AUTO (AUTO) ", and " CONTROLLER Power Source Monitor (PWON) ". These signals are MOSS Relay Contact Connections. The output current can be connected for either sinking or sourcing.

Voltage and Current Specifications

- Applied Voltage (V)  $\leq$  DC+30V
- Working Current (Ip)  $\leq$  100mA

Please refer to Fig. 33 for connections. Output circuit is need power source (DC+24V) separately (not included / prepared by the end-user).

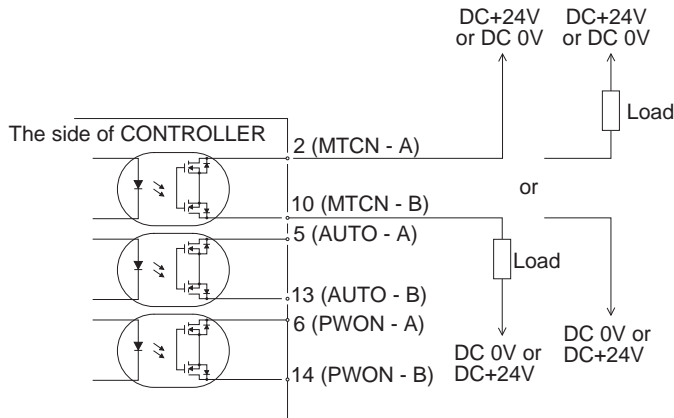

Fig. 33

### ② Emergency Stop Signal Input (Pin No. 1 - No. 9)

This signal is a switched DC+24V output.

Please use a separate power source that is capable of applying DC+24V  $\pm$  10%, 50mA. Refer to Fig. 34 below for connections.

Normal Operation circuit is ON (Closed).

Emergency Stop circuit is OFF (Open).

If the Emergency Stop Signal is OFF (Open) the Safety Relay in the SAFETY RELAY BOX is OFF, the power supply to the motor is interrupted and the motor stops.

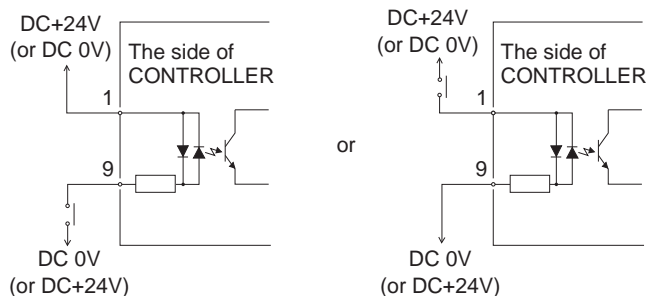

Fig. 34

### ③ Safety Relay Signal (Pin No. 3 - No. 11, No. 4 - No. 12)

- When there is continuity between Pin No. 3 (SAFE - 1A) and Pin No. 11 (SAFE - 1B) or between Pin No. 4 (SAFE - 2A) and Pin No. 12 (SAFE - 2B) the motor is off. If there is no continuity between these pairs of pins then the system is operating normally.
- If the Emergency Stop Signal is OFF (Open) the Safety Relay will be OFF (Open) and the motor power will be interrupted and the motor will stop.
- If the (NO) Normally Open contacts of the Safety Relay are welded together by an over load or short circuit the (NC) Normally Closed contacts separation are maintained with more than 0.5mm spacing by the relay's recoil mechanism.

- The voltage / current specifications of No. 3 (SAFE - 1A) - Pin No. 11 (SAFE - 1B) and Pin No. 4 (SAFE - 2A) - Pin No. 12 (SAFE - 2B).
  - Applied Voltage (V)  $\leq$  DC+30V
  - Working Current (Ip)  $\leq$  2A
- Refer to Fig. 35 for the connection diagram.

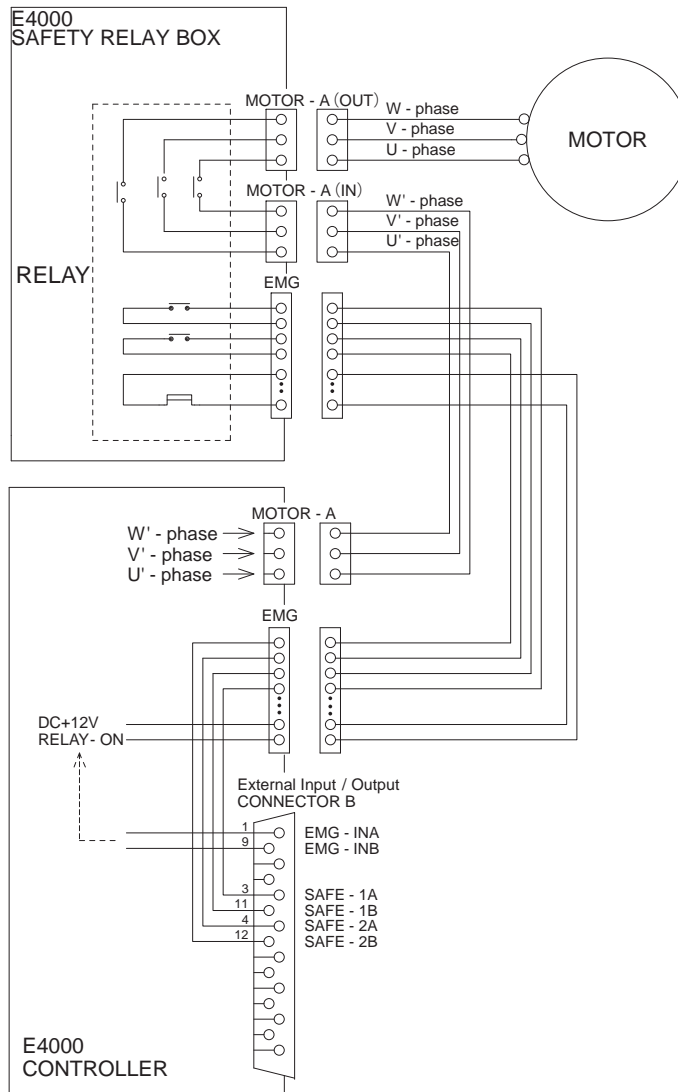

Fig. 35

\* Safety Relay

If an N - O contact becomes welded, all N - C contacts will maintain a minimum distance of 0.5 mm when the coil is not energized.

N - O contacts (Normally - opened contacts) : Motor Power Line

N - C contacts (Normally - closed contacts) : Contacts Output

\* Safety of the Machines when used the Safety Relay Contacts Output

• When input Emergency Stop Signal that is coupled to opening the movable guard of the Industrial Machinery, Safety Relay will operate and certainly open the Motor Power Line.

• Contact output ((SAFE-1A) - (SAFE - 1B), (SAFE - 2A) - (SAFE - 2B)) of the " N - C Contacts" can be used for detecting the opening of the Motor Power Line.

If " N - O contacts " become welded, contact outputs will certainly maintain OFF (Open) by Forced Guide Mechanism. Therefore, Safety Relay can be used as an opening signal of movable guard with locking mechanism for Industrial Machinery.

## 16 - 3 External Input / Output Connector Specifications

### CAUTION

- To minimize RF interference and noise, please keep the length of the cables as short as possible and route them separately or as far away as possible from high voltage electrical cables.
- Use only shielded cables to minimize RF interference and noise. Connect the shield to the plug cover.
- Connect the shielded line to the Input / Output connector. (The shielded line is grounded.) Do not connect another shielded line to any externally powered instrument.

(1) External Input / Output Connector A

Plug Part Number : XM2A - 2501 OMRON (or other similar high-quality product)

Cover Part Number : XM2S - 2511 OMRON (or other similar high-quality product)

(2) External Input / Output Connector B

Plug Part Number : XM2A - 1501 OMRON (or other similar high-quality product)

Cover Part Number : XM2S - 1511 OMRON (or other similar high-quality product)

- Please prepare a Cover and Plug.
- The shielding should be connected to the Cover.
- Use the Mounting Screw " M 2.6 ".

\*Fasten the Connector to the CONTROLLER using Mounting Screws (M2.6).

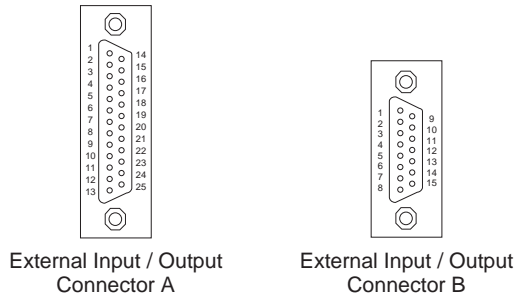

Fig. 36

## 17. PROTECT FUNCTION

### 17 - 1 WARNING FUNCTION

#### CAUTION

**When the warning LED on the CONTROLLER blinks, conditions exist that could result in dangerous operation. Check operating conditions and continue to use only after correcting the problem.**

Always check the CONTROLLER, Motor Spindle and the condition of the cooling air prior to use. This will help prevent system errors that will result in non-operational conditions.



- (1) The WARNING LED (WARNING) will blink.
- (2) The Warning Code (listed in Table. 6) will be displayed on the Digital Speed Indicator .
- (3) Warning Signal is output to the " WARNING " (PIN No. 20 : WARNING) of External Input / Output Connector A.

Table. 6

Warning Code	Warning Function	Trouble
A0	Motor Signal Line	Motor Signal Line or Connector not connected or damaged.
A1	Low Air Pressure	Low Air Pressure during motor rotation.
A2	CONTROLLER Overheat	CONTROLLER Overheat.
A3	Over Load	Motor Torque Load exceeding safe limits.
A4	Emergency Stop Signal	Emergency Stop Signal 'OFF (Open) ' in Emergency Stop Mode Condition.
A5	Over Air Pressure	Excessive Air Pressure
A6	Motor Overheat	The inside temperature of the motor has reached the warning level.
A7	Motor Power Line	Motor Power Line or Connector not connected or damaged.
AF	Temporary Motor / Spindle Operation during FAN malfunction	The FAN has stop, but the Motor / Spindle is temporarily operational. * While the Warning Code " AF " is displayed, the buzzer will sound.

\* If FAN has been stopped due to a malfunction, the motor / spindle can run temporarily (Refer to P93 " 18 - 4 ⑧  Temporary Motor / Spindle Operation if FAN has Stopped (80 Square Type) " section).

#### CAUTION

- **When the Warning LED blinks while the control is in Mode AUTO, be sure to confirm the Warning Code displayed on the Digital Speed Indicator by referring to the " Warning Code " in Table 6.**
- **If Parameter "  " is set to "  " and continuous operation continues during a FAN Failure, damage to the CONTROLLER and its internal components will occur due to excessive heat generation while the FAN is not operating. It is critical to reduce the cutting load conditions and operating time to minimize the risk of internal damage. to the CONTROLLER.**

### 17 - 2 Detection of unsafe operating conditions

Always check the CONTROLLER, motor, spindle and the condition of the cooling air prior to operation. This will help prevent system errors that will result in improper operating conditions.

When an Error Occurs, the following events may occur :

- (1) Motor stops.
- (2) The Error LED (ERROR) will lights.
- (3) The Error Code in Table. 6 will displayed on Digital Speed Indicator.
- (4) An Error signal is output to the " ERR (PIN No. 8 : ERROR ) " of External Input / Output Connector A.

\* Setting parameter  , will Change the Error Output Mode of the Error Signal. (Refer to P90 " 18 - 4 ①  Setting of Error Output Mode " section.)

## 17 - 3 Resetting System after Error Code

There are 2 methods of releasing Error Code.

(1) When the control is in MANUAL Mode:

Push the Error Reset Button (RESET) of the Control Panel.

(2) When the control is in AUTO Mode:

Toggle the signal on Pin No. 4 (RESET) of External Input / Output Connector A OFF (Open) → ON (Closed) → OFF (Open).

\* When releasing Error using the Motor Start / Stop (Pin No.14 : START) is ON (Closed), OFF (Open) Motor Start / Stop before resuming operation.

Table. 7

Error Code	Problem Area	Trouble
E1	Excess Current	Motor Current beyond safe limits.
E2	Over Voltage	Motor Voltage beyond safe limits.
E3	Motor Sensor Malfunction	The sensor signal has malfunctioned or Motor Cord (Signal Line) Connector is not connected.
E4	CONTROLLER Overheat	CONTROLLER Overheat.
E5	Brake Circuit Trouble	Trouble with the Motor Brake Circuit.
E6	Rotor Lock	Motor Stalled for more than 3 seconds.
E7	Low Air Pressure	Inadequate air pressure is supplied for more than 4 seconds during rotation or inadequate air pressure is supplied when a motor start commanded.
E8	Torque Over Load	Torque limits are exceeded for too long a period of time. (Refer to P85 " 17 - 4 Torque Over Load ".)
EA	External Control Signal Error	<ul style="list-style-type: none"> <li>When Control Mode is in AUTO, the Control Command Signal is " ON (Closed) " before Main Power Switch is turned ON.</li> <li>When Control Mode is AUTO, the ERROR command is released without stopping the Control Command Signal " OFF (Open) " .</li> </ul>
EL	Incompatible Motor	An unrecognizable motor is connected to the CONTROLLER.
EH	Over Speed	Rotating Speed is beyond the motors capability.
EE	Emergency Stop Error	Activated when Emergency Stop Signal is " OFF (Open) ", or when rotating, Emergency Stop occurred by Emergency Stop Signal " OFF (Open) " .
EC	Internal Memory Error	Internal Memory Problem (EEPROM).
EP	Motor Power Line Disconnected	Motor Cord (Power Line) Connector is not connected.
Et	Motor Overheat	The motors Internal Temperature has risen above an acceptable amount.
EF1	FAN Malfunction (80 Square Type)	FAN has Stopped (80 Square Type).
EF2	FAN Malfunction (40 Square Type)	FAN has Stopped (40 Square Type).
EFP	Parameter $\boxed{PB}$ Setting Error	A mistake has been made while setting Parameter $\boxed{PB}$ .

## CAUTION

- If when using the External Input / Output Connector A / B and External Monitoring, please check and resolve source of the problem whenever an Error Code is displayed on the Digital Speed Indicator.
- When an error occurs due to internal damage of the CONTROLLER, the Error Signal can not be reset. Please send the Motor spindle and CONTROLLER to a NAKANISHI dealer for repair.

### Error Code " EF1 "

- The FAN (80 Square Type) located on the rear of the Control Panel of the CONTROLLER has malfunctioned and stopped. The Protect Function of the CONTROLLER is operating and motor / spindle has stopped. The FAN (80 Square Type) needs to be replaced.  
This FAN can be replaced by the customer (Refer to P96 " 22. MAINTENANCE ").
- If the FAN has been stopped due to a malfunction, the motor / spindle can be temporarily operated by setting Parameter  $P_{88}$  to  $0n$  , until the FAN (80 Square Type) has been replaced (Refer to P93 " 18 - 4  $P_{88}$  Temporary Motor / Spindle Operation if FAN has Stopped (80 Square Type) " section).

### Error Code " EF2 "

The FAN (40 Square Type) located on the control board inside of the CONTROLLER has malfunctioned and stopped.

Immediate FAN replacement is necessary and it CANNOT be replaced by the customer. Return to a NAKANISHI dealer for service.

## 17 - 4 Torque Over Load

## CAUTION

If you constantly, operate the system in an overload condition, even for short periods of time, the CONTROLLER will overheat and damage to the control, motor and spindle are possible. NAKANISHI recommends only continuous duty operation (LOAD LED's with 3 LED's lit) : Torque Load Monitor (LOAD) Voltage should be less than DC+5V.

When the Load Monitor LED lights 4 or more LED's (3 Green LED's and 1 of more yellow LED's) an over-load condition exists.

During a motor overload period, the following will occurs:

- (1) Warning LED (WARNING) will blinks.
- (2) Warning Code " A3 " is displayed on the Digital Speed Indicator .
- (3) Warning Signal is output to the Pin No.20 (Warning) of External Input / Output Connector A .

Overload operation is considered a short-term operation mode. The allowable operation time depends on the number of lighted LED's on the Load Monitor LED (LOAD).

- (1) Load Monitor LED 4 LED's (Green LED 3, Yellow LED 1) : 30 Seconds
- (2) Load Monitor LED 5 LED's (Green LED 3, Yellow LED 2) : 10 Seconds
- (3) Load Monitor LED 6 LED's (Green LED 3, Yellow LED 2, Red LED 1) : 5 Seconds

When the allowable time is exceeded the motor will stop and the following occurs:

- (1) Error LED lights.
- (2) Error Code " E8 " is displayed on the Digital Speed Indicator .
- (3) Error Signal is output to Pin No. 8 (ERROR) of the External Input / Output Connector A .

\* Set the parameter  $P_{11}$  , can be Change the Error Output Mode of the Error Signal for an Open or Closed state. (Refer to P90 " 18 - 4 ①  $P_{11}$  Setting of Error Output Mode " section.)

## 18. SETTING OF OPERATING PARAMETERS

### 18 - 1 Entering Parameter Setting Mode

#### CAUTION

- When in the parameter mode, normal operation of starting, stopping, etc. operation is not possible.
- When changing from the parameter mode to normal operation, be sure to toggle the Main Power Switch OFF and ON again.

- (1) Make sure that the Main Power Switch is turned OFF.
- (2) While push and holding the Error Reset Button while turning the Power Switch ON at the rear of the CONTROLLER.
- (3) Hold the Reset Button down for 3 seconds while the CONTROL is powering up.
- (4) The buzzer will 'BEEP' 3 times, then release the Reset Button and Parameter Setting Mode will start. (P1) is Displayed.

### 18 - 2 Parameter Descriptions

Parameter types, contents, and default are detail in Table 8.

When checking a parameter or changing a parameter setting, refer to P90 " 18 - 4 Setting procedures " section.

Table. 8

Code	Types	Contents	Default
(P1)	Setting of Error Output Mode	Changes the Error Output Signal, when an error occurs, from normally open to normally closed.	(OFF)
(P2)	Setting AUTO Mode for Motor Speed Control	When the control is in AUTO mode, the speed control is adjustable from the CONTROLLER Panel, set the parameter to (an) to adjust the speed in AUTO Mode.	(OFF)
(P3)	Setting Fixed Motor Speed	When a Fixed Motor Speed is desired, set the parameter to (an) and set the desired locked in speed.	(OFF)
(P4)	Setting Maximum Motor Speed	When a Maximum Motor Speed is desired, set the parameter to (an) and set the maximum speed.	(OFF)
(P5)	Selection of External Speed Control Mode	The following Rotation Speed options can be selected when control mode is AUTO. (Rn) : Analog Signal    (cn) : Pulse Signal (Pa) : Speed Point Signal	(Rn)
(P6)	Selection of External Motor Start Signal Control Mode	When control mode is in AUTO, please set the parameter to (an) and set the desired rotating direction of the motor. Activate Pin No. 2 to set a reverse direction along with the start command.	(OFF)
(P7)	Setting of Motor Acceleration and Deceleration Time	If acceleration time of the Motor startup to Motor Maximum Rotation Speed or deceleration time of from Maximum Rotation Speed to motor stop need to be lengthened. Set the parameter to (an) and set the desired acceleration / deceleration time. (Acceleration time and deceleration time are common.)	(OFF)
(P8)	Temporary Motor / Spindle Operation if FAN has Stopped (80 Square Type)	If the FAN has malfunctioned and stopped, the Motor / Spindle can be temporarily operated.	(OFF)
(P9)	Confirmation of Parameter Setting	Contents of the parameters that are set can be confirmed. (P1) - (P8) .) No parameter setting is necessary.)	



## 18 - 3 Contents of Parameters

### CAUTION

The operating parameters can be preset depending on the application requirements. The operating parameter presets ( " Setting of Error Output Mode ", " Setting AUTO mode for Motor Speed Control ", " Setting Fixed Motor Speed ", " Setting Maximum Motor Speed ", " Selection of External Speed Control Mode ", " Selection of External Motor Start Signal Control Mode ", " Setting of Motor Acceleration and Deceleration Time " and " Temporary Motor / Spindle Operation if FAN has Stopped (80 Square Type)" ) are retained in non-volatile memory and will be maintained even if power is disconnected.  
Please operate only after confirming contents of parameter settings.

The following parameters can be set.

- ① **P1** Setting of Error Output Mode
- Selection of the error output mode is on Pin No. 8: ERR of External Input / Output Connector A.
  - When an error occurs the output can be select to ON (Closed) or OFF (Open).
  - Signals can be output according to the required machine control logic of the system.

Table. 9

Parameter <b>P1</b>	Set Contents
<b>OFF</b>	Error Occurred : Signal is OFF (Open).
<b>ON</b>	Error Occurred : Signal is ON (Closed).





- ② **P2** Setting AUTO Mode for Motor Speed Control
- Allows the setting of the Motor Speed while in AUTO Mode. This parameter selects between speed control with the Motor Speed Adjustment Button (SPEED  ,  ) of the Control Panel or by External Command Signal through External Input / Output Connector A.

Table. 10

Parameter <b>P2</b>	Set Contents
<b>OFF</b>	Set the Motor Rotation Speed by External Command Signal through External Input / Output Connector A.
<b>ON</b>	Set the Motor Rotation Speed by Motor Speed Adjustment Button (SPEED  ,  ) via the Control Panel.

- ③ **P3** Setting Fixed Motor Speed

### CAUTION

If you set the rotation speed higher than the rotation speed set at **P4**, rotation speed will be set according to **P4**.

- Allows the Motor speed to be fixed.
- Proactively prevents inadvertent change in speed.
- The Fixed Motor Speed can set by Control Mode MANUAL or AUTO.

Table. 11

Parameter <b>P3</b>	Set Contents
<b>OFF</b>	Fixed Motor Speed is not enabled.
<b>ON</b>	Fixed Motor Speed is enabled.

④ P4 Setting Maximum Motor Speed

**CAUTION**

**Actual motor rotation speed of the motor will be limited, based on maximum motor rotation speed of the type of motor connected.**

- Maximum Motor Speed can be set.
- Allows a safe maximum rotational speed limit depending on the application.
- The Maximum Motor Speed can be set by Control Mode MANUAL or AUTO.

Table. 12

Parameter P4	Set Contents
OFF	Setting of Maximum Motor Speed is not enabled.
ON	Setting of Maximum Motor Speed is enabled.

⑤ P5 Selection of External Speed Control Mode

**CAUTION**

**Actual motor rotation speed of the motor will be limited, based on maximum motor rotation speed of the type of motor connected.**

When Control Mode is in AUTO, it is possible to select the External Speed Control Mode from Analog Signal (Rn), Pulse Signal (cn), or Speed Point Signal (po). Speed preset in the control according to u1 - u4.

Table. 13

Parameter P5	Set Contents
Rn	Set speed by Analog Signal.
cn	Set speed by Pulse Signal.
po	Set speed by Speed Point Signal.

- When setting by Analog Signal (Rn), use the External Input / Output Signal " Motor Speed Control Voltage (Pin No. 23 : VR) ".
- When setting via the Pulse Signal (cn), use the External Input / Output Signal " Count Pulse Signal for Setting Motor Speed (Pin No. 3 : CNT\_IN) " and External Input / Output Signal " UP / DOWN Signal for Setting Motor Speed (Pin No. 15 : UD\_IN) ". The motor speed change per pulse is 100 min<sup>-1</sup> (rpm). External Input / Output Signal UP / DOWN Signal for Setting Motor Speed is as follows:  
 OFF (Closed) : Rotation speed decreases  
 ON (Open) : Rotation speed increases
- When setting by Speed Point Signal (po), select the Speed Point (u1 - u4) by using the combination of Speed Point Select 0 (Pin No.17 : SEL0) and Speed Point Select 1 (Pin No. 5 : SEL1).

Table. 14

Speed Point	SEL1 (Pin No. 5)	SEL0 (Pin No. 17)
u1	OFF (Open)	OFF (Open)
u2	OFF (Open)	ON (Closed)
u3	ON (Closed)	OFF (Open)
u4	ON (Closed)	ON (Closed)

- Can setting the different rotation speed in 4 Speed Points (u1 - u4). Speed ranges from 1,000 - 40,000min<sup>-1</sup> (rpm) can be set.

⑥ **P5** Selection of External Motor Start Signal Control Mode

- During Auto Control Mode the motor Start signal can either by a direction signal and a Start signal or a FWD. Start and a REV. Start signal.
- When in Auto Control Mode, the Motor Start Signal can be used for either forward or reverse direction by commanding a Direction Signal and a Start Signal. When set, the rotation direction is controlled by " Rotating Direction Setting (Pin No. 2 : DIR\_IN) ", FWD. (Open), Rev. (Closed) and the Start Signal is controlled by " Rotate Command (Pin No. 14 : START) ". When **P5** is set to **0n** FWD. rotation is controlled by " Rotate Command (Pin No. 14 : START) " and REV. rotation is controlled by " Rotating Direction Setting (Pin No. 2 : DIR\_IN) ".

Table. 15

Parameter <b>P5</b>	Set Contents
<b>0FF</b>	Motor startup and rotating direction is not commanded by signal.
<b>0n</b>	The startup motor with FWD. rotation or the startup motor with REV. rotation.

⑦ **P7** Setting of Motor Acceleration Time and Deceleration Time

- Sets the time from the Motor start-up until reaching the maximum Motor speed, and the Deceleration Time from the maximum Motor speed to stop.
- Display unit is second. Acceleration Time and Deceleration Time setting range : 2 - 60 seconds.
- Acceleration Time and Deceleration Time are common. Setup Value Unit : Seconds.

Table. 16

Parameter <b>P7</b>	Set Contents
<b>0FF</b>	Acceleration / Deceleration Time of the motor is not enabled.
<b>0n</b>	Acceleration / Deceleration Time of the motor is enabled.

Table. 17

Setup Value (Unit : Seconds)	Display
2	2
4	4
8	8
10	10
12	12
14	14
16	16
18	18
20	20
25	25
30	30
45	45
60	60

⑧ **P8** Temporary Motor / Spindle Operation if the FAN has stopped (80 Square Type)

### CAUTION

**Set Parameter **P8** to **OFF**, after replacing the FAN (80 Square Type). When FAN (80 Square Type) is operating normally, and parameter **P8** is set to **ON**, the Error Code " EFP " will be displayed.**

If FAN (80 Square Type) has stopped due to a malfunction, the motor / spindle can be temporarily operated by setting parameter **P8** to **ON**, until replacement of the FAN (80 Square Type) has been completed.

If FAN (40 Square Type) has been stopped by malfunction, no motor operation is possible until the FAN is replaced.

Table. 18

Parameter <b>P8</b>	Set Contents
<b>OFF</b>	FAN stop (80 Square Type) : Motor / Spindle operation has stopped.
<b>F1</b>	FAN stop (80 Square Type) : Motor / Spindle can still be run. Outputs an External Warning Signal (WARNING) to the CONTROLLER.
<b>F2</b>	FAN stop (80 Square Type) : Motor / Spindle can still be run. Does not Output an External Warning Signal (WARNING) to the CONTROLLER. If other Warning Codes other than " AF " occur, these output signals will be sent to the CONTROLLER (External Warning Signal) (WARNING).

⑨ **P9** Confirmation of Parameter Setting



This mode allows the user to check the settings of parameters **P1** - **P8**. The parameter **P9** can not be checked.

## 18 - 4 Setting Procedures









① **P1** Setting of Error Output Mode

### CAUTION

**If the Error Output Mode has been changed from the default setting, the parameter setting will be displayed the next time you enter Parameter Setting Mode.**

- Procedure
1. Push the Start / Stop Button (START / STOP).
  2. **OFF** is displayed. This indicates that when an error occurs, the output will be OFF (Open).
  3. Push the Start / Stop Button (START / STOP).
  4. **ON** is displayed. This indicates that when an error occurs, the output will be ON (Closed).
  5. You can cycle through the choices by pushing the Start / Stop Button (START / STOP).
  6. Push the Error Reset Button (RESET) to send the settings to memory, **P1** will be displayed.
  7. If you desire to set other parameters, press the Motor Speed Adjustment Button (SPEED , ) to select the parameter that needs to be set.
  8. When you are finished setting parameters, press the Error Reset Button (RESET), then turn the Main Power Switch OFF.







## ② Setting AUTO Mode for Motor Speed Control

- Procedure
1. Push the Start / Stop Button (START / STOP).
  2.  is displayed. This indicates that speed control by the Motor Speed Adjustment Button (SPEED  ,  ) is disabled. The External Command Signal Control will be operational.
  3. Push the Start / Stop Button (START / STOP).
  4.  is displayed. This indicates that speed control is changeable by the Motor Speed Adjustment Button (SPEED  ,  ).
  5. You can cycle through the choices by pushing the Start / Stop Button (START / STOP).
  6. Push the Error Reset Button (RESET) to send the settings to memory,  will be displayed.
  7. If you desire to set other parameters, press the Motor Speed Adjustment Button (SPEED  ,  ) to select the parameter that needs to be set.
  8. When you are finished setting parameters, press the Error Reset Button (RESET), then turn the Main Power Switch OFF.

## ③ Setting Fixed Motor Speed

### CAUTION







**Actual motor rotation speed of the motor will be limited, based on maximum motor rotation speed and the type of motor connected.**

- Procedure
1. Push the Start / Stop Button (START / STOP).
  2.  is displayed. This indicates that Fixed Motor Rotation Speed can not be set.
  3. Push the Start / Stop Button (START / STOP).
  4. The setting motor rotation speed displayed on Digital Speed Indicator.
  5. Push the Motor Speed Adjustment Button (SPEED  ,  ) to set the motor rotation speed. The Moto Rotation Speed range is 1,000 - 40,000min<sup>-1</sup> (rpm)
  6. Push the Error Reset Button (RESET) to send the settings to memory,  will be displayed.
  7. If you desire to set other parameters, press the Motor Speed Adjustment Button (SPEED  ,  ) to select the parameter that needs to be set.
  8. When you are finished setting parameters, press the Error Reset Button (RESET), then turn the Main Power Switch OFF.

## ④ Setting Maximum Motor Speed

### CAUTION

**Actual motor rotation speed of the motor will be limited, based on maximum motor rotation speed and the type of motor connected.**

- Procedure
1. Push the Start / Stop Button (START / STOP).
  2.  is displayed. This indicates that Maximum Motor Rotation Speed can not be set. The Maximum Motor Rotation Speed is 40,000min<sup>-1</sup> (rpm).
  3. Push the Start / Stop Button (START / STOP).
  4. The Maximum Motor Rotation Speed is displayed on Digital Speed Indicator.
  5. Push the Motor Speed Adjustment Button (SPEED  ,  ) to set the motor rotation speed. The Moto Rotation Speed range is 1,000 - 40,000min<sup>-1</sup> (rpm).
  6. Push the Error Reset Button (RESET) to send the settings to memory,  will be displayed.
  7. If you desire to set other parameters, press the Motor Speed Adjustment Button (SPEED  ,  ) to select the parameter that needs to be set.
  8. When you are finished setting parameters, press the Error Reset Button (RESET) , then turn the Main Power Switch OFF.

## ⚠ CAUTION

**Actual motor rotation speed of the motor will be limited, based on maximum motor rotation speed and the type of motor connected.**

- Procedure
1. Push the Start / Stop Button (START / STOP).
  2. Pn is displayed.
    - 2 - 1 If wish to set rotation speed via an Analog Signal (Motor Speed Control Voltage).
      - (1) Push the Error Reset button (RESET) to write the setting into memory.
      - (2) P5 will be displayed.
      - (3) If you desire to set other parameters, press the Motor Speed Adjustment Button (SPEED ⬆, ⬇) to select the parameter that needs to be set.
      - (4) When you are finished setting parameters, press the Error Reset Button (RESET), then turn the Main Power Switch is OFF.
    - 2 - 2 To set rotation speed using a Pulse Signal.
      - (1) Push the Motor Speed Adjustment Button (SPEED ⬆, ⬇). Pn displayed on Digital Speed Indicator.
      - (2) Push the Error Reset Button (RESET).
      - (3) To send the settings to memory, P5 will be displayed.
      - (4) If you desire to set other parameters, press the Motor Speed Adjustment Button (SPEED ⬆, ⬇) to select the parameter that needs to be set.
      - (5) When you are finished setting parameters, press the Error Reset Button (RESET), then turn the Main Power Switch is OFF.
    - 2 - 3 To set rotation speed using the Speed Point Signal.
      - (1) Push the Motor Speed Adjustment Button (SPEED ⬆, ⬇). Pn displayed on Digital Speed Indicator. This indicates u1 to u4 the 4 Speed points can be set.
      - (2) Push the Start / Stop Button (START / STOP).
      - (3) Alternately displayed u1 and setting speed. The Speed Point u1 can be set. Push the Motor Speed Adjustment Button (SPEED ⬆, ⬇) to set the motor rotation speed. Push the Error Reset Button (RESET). P5 is displayed. If you are continuously setting these parameters, push the Start / Stop Button (START / STOP).
      - (4) Alternately displayed u2 and setting speed. The Speed Point u2 can be set. Press the Motor Speed Adjustment Button (SPEED ⬆, ⬇) to set the motor rotation speed. Push the Error Reset Button (RESET). P5 is displayed. If you are continuously setting these parameters, push the Start / Stop Button (START / STOP).
      - (5) Alternately displayed u3 and setting speed. The Speed Point u3 can be set. Press the Motor Speed Adjustment Button (SPEED ⬆, ⬇) to set the motor rotation speed. Push the Error Reset Button (RESET). P5 is displayed. If you are continuously setting these parameters, push the Start / Stop Button (START / STOP).
      - (6) Alternately displayed u4 and setting speed. The Speed Point u4 can be set. Press the Motor Speed Adjustment Button (SPEED ⬆, ⬇) to set the motor rotation speed. Push the Error Reset Button (RESET). P5 is displayed. If you are continuously setting these parameters, push the Start / Stop Button (START / STOP).
  3. If you desire to set other parameters, press the Motor Speed Adjustment Button (SPEED ⬆, ⬇) to select the parameter that needs to be set.
  4. When you are finished setting parameters, press the Error Reset Button (RESET), then turn the Main Power Switch OFF.

## ⑥ P5 Selection of External Motor Start Signal Control Mode

- Procedure
1. Push the Start / Stop Button (START / STOP).
  2. **GFP** is displayed. This indicates that motor startup and setting the rotation direction can not performed simultaneously.
  3. Push the Start / Stop Button (START / STOP).
  4. **GR** is displayed. This setting is right hand rotation with motor startup by Rotation Command (Pin No. 14 : START) or left hand rotation with motor startup by Rotating Direction (Pin No. 2 : DIR\_IN) are can be set.
  5. You can cycle through the choices by pushing the Start / Stop Button (START / STOP).
  6. Push the Error Reset Button (RESET) to send the settings to memory, **P5** will be displayed.
  7. If you desire to set other parameters, press the Motor Speed Adjustment Button (SPEED ▲, ▼) to select the parameter that needs to be set.
  8. When you are finished setting parameters, press the Error Reset Button (RESET), then turn the Main Power Switch OFF.

## ⑦ P7 Setting of Motor Acceleration Time and Deceleration Time

- Procedure
1. Push the Start / Stop Button (START / STOP).
  2. **GFP** is displayed. In this setting, the Acceleration Time and Deceleration Time is 2 seconds, which is the factory default time setting.
  3. Push the Start / Stop Button (START / STOP).
  4. Alternately displayed **GR** and the Acceleration Time / Deceleration time (default 2 secons).
  5. Push the Motor Speed Adjustment Button (SPEED ▲, ▼) select the setting time. (The Acceleration Time / Deceleration time.) (Unit : Seconds)
  6. Push the Error Reset Button (RESET) to send the settings to memory, **P7** will be displayed.
  7. If you desire to set other parameters, press the Motor Speed Adjustment Button (SPEED ▲, ▼) to select the parameter that needs to be set.
  8. When you are finished setting parameters, press the Error Reset Button (RESET) , then turn the Main Power Switch OFF.

## ⑧ P8 Temporary Motor / Spindle Operation if FAN has Stopped (80 Square Type)

- Procedure
1. Push the Start / Stop Button (START / STOP).
  2. **GFP** is displayed. This setting is for FAN (80 Square Type) and the motor / spindle is stopped.
  3. Push the Start / Stop Button (START / STOP) again.
  4. **F1** is displayed. This setting is for temporary motor / spindle operation when FAN (80 Square Type) has been stopped due to the FAN failure.  
An Output to the External Warning Signal (WARNING) will be sent to the CONTROLLER.
  5. Push the Start / Stop Button (START / STOP).
  6. **F2** is displayed. This setting is for temporary motor / spindle operation when FAN (80 Square Type) has been stopped due to a FAN failure. An Output to the External Warning Signal (WARNING) will be sent to the CONTROLLER. If other Warning Codes occur other than "AF", these signals will be sent to the CONTROLLER (External Warning Signal) (Warning).
  7. Push the Error Reset Button (RESET).
  8. If you desire to set other parameters, press the Motor Speed Adjustment Button (SPEED ▲, ▼) to select the parameter that needs to be set.
  9. When you are finished setting parameters, press the Error Reset Button (RESET), then turn the Main Power Switch OFF.

## ⑨ P9 Confirmation of Parameter Setting

- Procedure
1. Push the Start / Stop Button (START / STOP).
  2. The setting contents of the P1 ( OFF or ON ) and P1 are displayed.
  3. Push the Start / Stop Button (START / STOP).
  4. The setting contents of the P2 ( OFF or ON ) and P2 are displayed.
  5. Push the Start / Stop Button (START / STOP).
  6. The setting contents of the P3 ( OFF or Setting Motor Speed) and P3 is displayed.  
When motor rotation speed is 30,000min<sup>-1</sup> (rpm), 3000 is displayed.
  7. Push the Start / Stop Button (START / STOP).
  8. The setting contents of the P4 ( OFF or Maximum Motor Speed) and P4 is displayed.
  9. Push the Start / Stop Button (START / STOP).
  10. The setting contents of the P5 ( OFF or ON ) and P5 are displayed.
  11. Push the Start / Stop Button (START / STOP).
  12. The setting contents of the P6 ( OFF or ON ) and P6 are displayed.
  13. Push the Start / Stop Button (START / STOP).
  14. The setting contents of the P7 ( OFF or ON ) and P7 are displayed.
  15. The setting contents of the P8 ( OFF, F1 or F2 ) and P8 are displayed.
  16. You can cycle through the choices by pushing the Start / Stop Button (START / STOP).
  17. If you desire to set other parameters, press the Motor Speed Adjustment Button (SPEED ▲, ▼) to select the parameter that needs to be set.
  18. When finished CHANGING parameters and wish to exit the Parameter Mode, press Error Reset Button (RESET), the cycle the controls main power switch off, then ON.

## 19. CONTROL PANEL SETTING RESUME FUNCTION

On power up, the system will resume all the control panel settings in the state they were in when the CONTROLLER was Powered OFF.

The following settings will be maintained

- (1) Motor Rotation Speed
- (2) Rotation Direction (FWD., REV.)
- (3) Control Mode (MANUAL, AUTO)
- (4) Parameter Settings P1 - P8

## 20. BREAK IN PROCEDURE

During transportation, storage or installation the grease inside the bearings will settle. If the spindle is suddenly run at high-speed, the lack of evenly distributed grease will cause excessive heat leading to bearing damage.

After installation, repair, initial operation, or long periods of non operation please follow the break-in procedure.

Please refer to the " BREAK IN PROCEDURE " in Operation Manual of the Motor / Spindle.

## 21. OPTIONAL DEVICES FOR CONTROLLER

### 21 - 1 E4000 SAFETY RELAY BOX

When using the E4000 SAFETY RELAY BOX, connect to the E4000 CONTROLLER.

#### (1) Features

##### ① Safety Relay

If an " N - O Contacts " becomes welded, all " N - C Contacts " will maintain a minimum distance of 0.5 mm when the coil is not energized.

" N - O Contacts " (Normally-opened contacts) : Motor Power Line

" N - C Contacts " (Normally-closed contacts) : Contacts Output



- ② Safety of the Machines when used the Safety Relay Contacts Output
- When input Emergency Stop Signal that is coupled to opening the movable guard of the Industrial Machinery, Safety Relay will operate and certainly open the Motor Power Line.
  - Contact output ((SAFE-1A) - (SAFE - 1B), (SAFE - 2A) - (SAFE - 2B)) of the " N - C Contacts " can be used for detecting the opening of the Motor Power Line.  
If " N - O Contacts " become welded, contact outputs will certainly maintain OFF (Open) by Forced Guide Mechanism. Therefore, Safety Relay can be used as an opening signal of movable guard with locking mechanism for Industrial Machinery.

(2) Specifications

Table. 19

Product Name	E4000 SAFETY RELAY BOX	
Model	E4000 - SRB	
Weight	850g (Main Body)	
Standard Accessories	<ul style="list-style-type: none"> <li>• Relay Cord • • 1pc.</li> <li>• Connector Cover • • 2pcs.</li> <li>• Operation Manual • • 1set.</li> </ul>	<ul style="list-style-type: none"> <li>• Emergency Stop Cord • • 1pc.</li> <li>• Connector Cap • • 1pc.</li> </ul>

## 21 - 2 E4000 Control Panel Extension Cord

(1) Features

This control panel extension cord is designed so the Operation Panel can be mounted (4m) from the E4000 CONTROLLER.

(2) Specifications

Table. 20

Product Name	E4000 Control Panel Extension Cord	
Model	E4000 - PEX4	
Front Panel Dimensions	73mm x 73mm	
Attachable Pitch	63mm x 63mm	
Attachable Hole Dimensions	φ 3.4mm	
Cord Length	4m	
Standard Accessories	<ul style="list-style-type: none"> <li>• Mounting Screw (M3) • • 4pcs.</li> </ul>	<ul style="list-style-type: none"> <li>• Operation Manual • • 1set.</li> </ul>

## 21 - 3 E4000 BOX for Control Panel

(1) Features

This is a convenient stand-off used to mount the E4000 Control Panel Extension Cord to the machines control for operator convenience.

(2) Specifications

Table. 21

Product Name	E4000 BOX for Control Panel	
Model	E4000 - PB	
Weight	216g	
Standard Accessories	<ul style="list-style-type: none"> <li>• Case A • • 1pc.</li> <li>• Blind Plate • • 1pc.</li> <li>• Mounting Screw (M4) • • 2pcs.</li> </ul>	<ul style="list-style-type: none"> <li>• Case B • • 1pc.</li> <li>• Mounting Screw (M3) • • 6pcs.</li> <li>• Operation Manual • • 1set.</li> </ul>

## 22. MAINTENANCE

### 22 - 1 Cooling FAN

The FANS (80 Square Type and 40 Square Type) for CONTROLLER cooling are located on the inside of the CONTROLLER.

FAN (80 Square Type) : Located on rear of the Control Panel inside of the CONTROLLER.

The FAN (80 Square Type), can be replaced by the customer (Replace in accordance with " 22 - 2 FAN (80 Square Type) Replacement Method ").

FAN (40 Square Type) : Located on the control board inside of the CONTROLLER.

If a malfunction of the (40 Square Type) FAN should occur, immediate repair is necessary. Return the CONTROLLER to NAKANISHI dealer service.

### 22 - 2 FAN (80 Square Type) Replacing Method

#### **⚠ DANGER**

**NAKANISHI warns all end-users not to replace the E4000 - FAN : FAN (80 Sqare Type) while the Control Power is ON, or if there is power connected to the main power cord. Disconnect the main power from its power source and release the supplied air to the AIR IN quick disconnect before replacing the E4000 - FAN (80 Sqare Type). Not following these instructions may lead to serious injury or death due to electric shock.**

#### **⚠ WARNING**

**Disassembly and assembly of the CONTROLLER should be for the purpose of replacing the FAN (80 Square Type) only. Disassembly and assembly should be performed in accordance with this Instruction Manual. Do not disassemble this CONTROLLER for any other reason.**

#### **⚠ CAUTION**

**When disassembling the E4000 CONTROLLER, note the loss of any removed screws. Account for all screws when reassembling.**

- (1) Turn OFF the Main Power Switch of the CONTROLLER. Turn OFF the Power supply and Air supply to the CONTROLLER.
- (2) Remove the Mounting Screws (2pcs.) from the Case (Chassis) of the CONTROLLER (Fig. 37).
- (3) Remove the Power Cord Round Terminal from the main power supply terminal.  
Remove the Power Cord, Motor Cord, Air Hose, Protective Cover A, B and options etc. from the CONTROLLER.



Fig. 37



Fig. 38

- (4) Remove the Case (Front Panel) from the CONTROLLER (Fig. 39).
- (5) Remove the FAN Cord (Fig. 40).

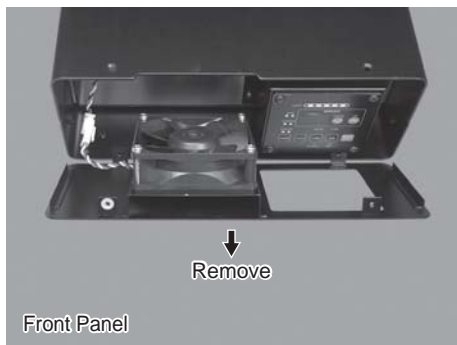

Fig. 39

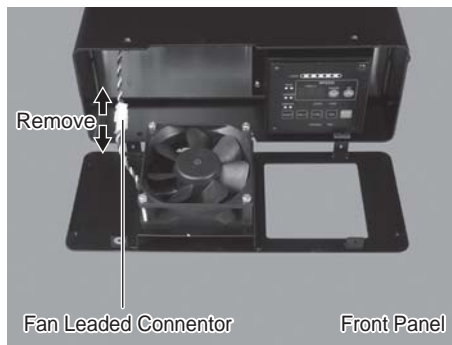

Fig. 40

- (6) Remove the FAN Mounting Screws (4pcs.) from the Case (Front Panel) of the CONTROLLER (Fig. 41).
- (7) Remove the FAN from the Case (Front Panel) of the CONTROLLER (Fig. 42).
- (8) Remove the Plate for FAN from the Case (Front Panel). Clean the Case (Front panel) and Plate with a lint-free cloth (Fig. 42).

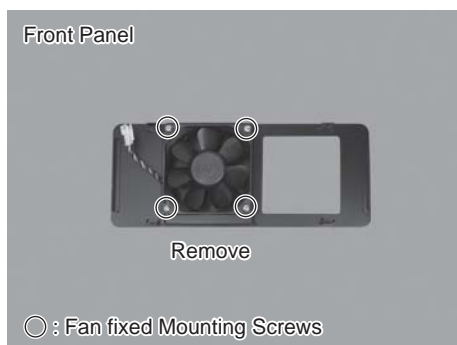

Fig. 41

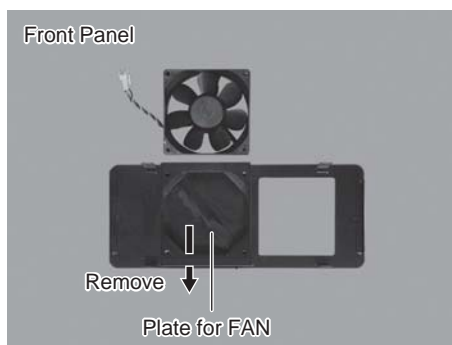

Fig. 42

- (9) Position the Plate for FAN on the Case (Front Panel) as shown in Fig. 43.
- (10) Mount the Replacement FAN onto the Case (Front Panel) by using FAN Mounting Screws (4pcs.) (Specified Torque :  $0.5N \cdot m \pm 0.1$ ) (Fig. 44).

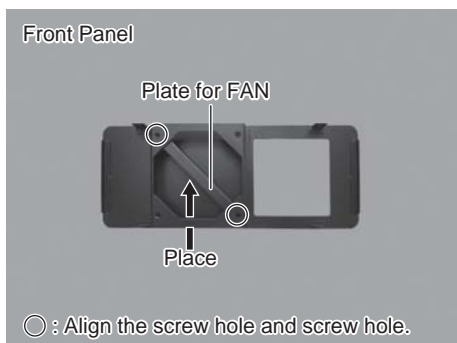

Fig. 43

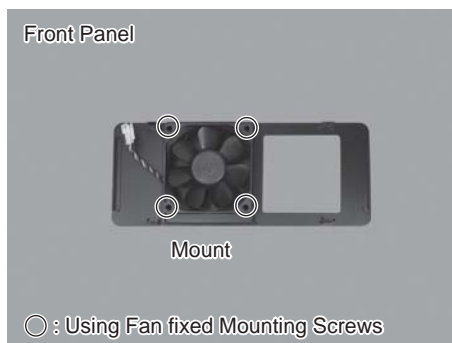

Fig. 44

- (11) Connect the FAN Cord Connector (Fig. 45).
- (12) Re-attach the Front Panel to the CONTROLLER's Main Body (Fig. 45).

## ⚠ CAUTION

After inserting the FAN Cord, gently pull on the FAN Cord to make sure that the FAN Cord Connector will not come loose.

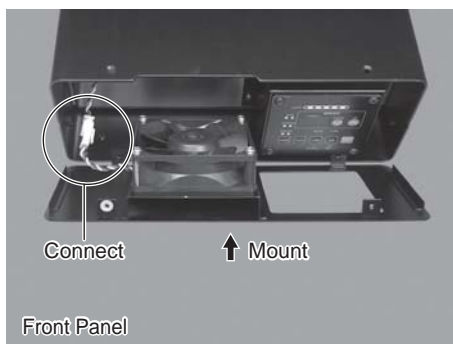

Fig. 45

- (13) Secure the top of the Case (Cover) to the CONTROLLER'S main body using the Mounting Screws (2pcs.). (Fig. 46).
- (14) Secure the Case (Chassis) to the CONTROLLER'S main body by using the Mounting Screws (2pcs. each). (Fig. 47).



Fig. 46



Fig. 47

## 22 - 3 Confirmation of FAN Operation

- (1) Turn ON the Power Supply to the CONTROLLER.
- (2) Turned ON the Main switch on the CONTROLLER.
- (3) Make sure that the Error Code " EF1 " on the display of the CONTROLLER is no longer displayed.  
No Error Code means that FAN is in normal operation.

\* If Error Code " EF1 " is displayed on the display of the CONTROLLER.

- ① Once again, turn OFF the Main Power Switch on the CONTROLLER and the incoming Power Supply .
- ② Check the connection of the FAN Cord by disassembling the CONTROLLER again.
- ③ Recheck the FAN Operation by re-assembling the CONTROLLER. If all functions are in Normal Operation, continue on to a " 22 - 4 Confirmation of Normal Operation " .

If once again Error Code " EF " is displayed on the display of the CONTROLLER, proceed no further. As this may cause damage to the FAN or CONTROLLER. Return the CONTROLLER and replacement FAN to an authorized NAKANISHI Dealer Service Center.

If Error Code " EFP " is displayed, set Parameter  $\overline{PB}$  to  $\overline{GFP}$  .

## 22 - 4 Confirmation of Normal Operation

Re-supply Air the CONTROLLER. Turn the CONTROLLER's Power Switch ON. Check for normal CONTROLLER functions.

- If CONTROLLER is not operating normally, the CONTROLLER may be damaged. Return to a NAKANISHI Dealer Service Center.

## 23. TROUBLESHOOTING

If a problem or concern occurs, please check the following prior to consulting your dealer.

Trouble	Cause	Inspection / Corrective Active
Motor does not run.	Power is not supplied.	<ul style="list-style-type: none"> <li>• Make sure to turn ON the Main Power Switch on the rear of the CONTROLLER.</li> <li>• Make sure to connect the round terminal of the Power Cord to the AC Power Input Terminal Block securely. (Refer to P65 " 11. POWER CORD CONNECTION " section.)</li> </ul>
	Motor Cord Plug (Power Line or Signal Line) is not connected to the motor and CONTROLLER.	Connect the Motor Cord plug (Power Line or Signal Line) correctly to the Motor and CONTROLLER.
	Control Button (CTRL) is set to Manual mode but trying to start with an External Command Signal through External Input / Output Connector A.	Start with the Start / Stop Button (START/ STOP), or set the Control Button (CTRL) on the Control Panel to Auto mode.
	Control Button (CTRL) is set to Auto mode but trying to manually start with the Start Button (START/ STOP) on the Control Panel.	Start with an External Command Signal or set the Control Button on the Control Panel to Manual mode. ( When Start with an External Command Signal, refer to P72 " 16 - 1 (1) Details of External Input / Output Connector A Signal Table. 4 Pin No. 14 " )
	When using the E4000 Safety Relay Box, Emergency Stop Signal is OFF (Open).	Set Emergency Stop Signal to be "ON" (close).
	An Error has occurred. (Error LED is lit.)	Check P84 " 17 - 3 Resetting System after Error Codes. Refer to Table 7 ". Error will not be released until cause of the error has been removed.
	Low Air Pressure	Adjust to the air pressure 0.2 - 0.35MPa (29.0 - 50.8psi).
Motor Speed is not displayed correctly.	Incorrect Motor Speed	Confirm the commanded rotation speed of connected motor and commanded rotation speed motor voltage is correct. (Refer to Operation Manual of the Motor Spindle).
	Motor Fixed Speed is set in the parameter $\text{P}3$ .	Release parameter $\text{P}3$ . (Refer to P91 " 18 - 4 ③ $\text{P}3$ Setting Fixed Motor Speed " section.)

Trouble	Cause	Inspection / Corrective Active
Motor Speed is not displayed correctly.	The Maximum Motor Rotation speed not more than desired Motor Rotation Speed set by parameter $P4$ .	Setting the Maximum Motor Rotation Speed more than Motor Rotation Speed by parameter $P4$ . (Refer to P91 " 18 - 4 ④ $P4$ Setting Maximum Motor Speed " section.)
	Incorrect setting of the Motor Rotation Speed as set by parameter $P5$ .	Setting the Motor Rotation Speed by selected Motor Speed Rotation set in parameter $P5$ . If in AUTO, $P2$ is set to OFF, change $P2$ to ON.
Spindle does not rotate or rotate smoothly.	The spindles bearings have been damaged.	Replace the ball bearings. (Return to NAKANISHI dealer service.)
	The motor has been damaged.	Replace the motor. (Return to NAKANISHI dealer service.)
Overheating during rotation.	Cutting debris has contaminated the ball bearings, and the ball bearings are damaged.	Replace the ball bearings. (Return to NAKANISHI dealer service.)
	Low air pressure.	Check air hose connection and air pressure.
Abnormal vibration or noise during rotation.	The tool is bent.	Replace the tool.
	Cutting debris has contaminated the ball bearings.	Replace the ball bearings. (Return to NAKANISHI dealer service.)
	The spindle bearings has been damaged.	
Tool slippage.	Collet or collet nut are not correctly installed.	Check and clean the collet and collet nut. Reinstall the collet and collet nut.
	The collet and the collet nut are worn.	Replace the collet and collet nut.
High run-out.	The tool is bent.	Change the tool.
	Collet nut is not correctly installed.	Secure the collet and the collet nut correctly.
	The collet and the collet nut are worn.	Replace the collet and the collet nut.
	Inside of the spindle is worn.	Replace the spindle shaft. (Return to NAKANISHI dealer service.)
	Contaminants inside the collet and the collet nut or the spindle.	Clean the collet, collet nut and the inside of the taper and spindle.
	The spindle bearings have been damaged.	Replace the ball bearings. (Return to NAKANISHI dealer service.)

## 24. DISPOSAL OF THE CONTROLLER

When disposal of a CONTROLLER is necessary, follow the instructions from your local government agency for proper disposal of electrical components .



---

株式会社 **ナカニシ** [www.nakanishi-inc.com](http://www.nakanishi-inc.com)

本社・工場 〒322-8666 栃木県鹿沼市下日向 700  
TEL : 0289(64)3380 FAX : 0289(62)5636

本書の内容は、改善のため予告無しに変更することがあります。

**NAKANISHI INC.**  [www.nakanishi-inc.com](http://www.nakanishi-inc.com)

700 Shimohinata, Kanuma, Tochigi 322-8666, Japan

**NSK America Corp** [www.nskamericacorp.com](http://www.nskamericacorp.com)

1800 Global Parkway, Hoffman Estates, IL 60192, USA

Contents are subject to change without notice.