

Brushless Motor EM-3080J / EM-3080J-2M

OPERATION MANUAL

OM-K0586E

Thank you for purchasing brushless motor.



Brushless motors are required to drive E3200 Series spindles with NE260 Control unit.

Please read this operation manual carefully prior to use.

1 CAUTIONS IN OPERATING

■ Read these cautions carefully and only use in the manner intended.

■ Safety instructions are intended to avoid potential hazards that could result in personal injury or damage to the device. Safety instructions are classified as follows in accordance with the seriousness of the risk.

Class	Degree of Risk
 WARNING	Existence of a hazard that could result in bodily injury or damage to the device, if the safety instructions are not followed.
 CAUTION	Possibility of a hazard that could result in light to medium degree of bodily injury or damage to the device, if the safety instructions are not followed.

WARNING

- ① **NAKANISHI** product's are intended for use by trained, knowledgeable, highly experienced professionals only.
- ② Brushless motors are not designed as a hand tool. Install it on a machine such as a lathe or special purpose machine.
- ③ Do not touch the spindle during rotation.
- ④ Wear safety glasses, dust mask and hearing protection and use a protective cover around the spindle whenever spindle is operating.
- ⑤ When installing a motor/spindle to a fixed base, make sure the fixed base is grounded in order to avoid the risk of an electric shock.
- ⑥ Never touch the power cord by your wet hand. This may cause electric shock.
- ⑦ Never operate or handle the product until you have thoroughly read the owner's manual and safe operation is confirmed.
 - Handle or operate the product only after sufficient precautions to prevent injury have been taken and safety is confirmed.
 - Prior to operating the product confirm that all of the above safety precautions have been taken. Do not connect the product to an energy source or supply compressed air until all safety checks have been confirmed.

⚠ CAUTION

- ① Do not drop or hit the spindle because the shock can damage internal components.
- ② If you observe abnormal conditions during run-in, stop the motor and re-start procedure. If problems persist, please send the motor and spindle to NAKANISHI for repair.
- ③ Please use this product below a permissible rotational speed of the spindle and the reducer.
- ④ Do not disassemble, modify or attempt to repair the motor as it will damage internal components and there are no user serviceable parts, so it can't be repaired.
- ⑤ Stop working immediately when abnormal rotations or unusual vibration are observed.

2 FEATURES

- ① The compact housing is $\phi 30$ mm precision ground stainless steel (SUS).
- ② High-speed brushless motor does not require messy brush replacement.
- ③ Air-cooling system with a small volume of air (30 ℓ /min) is used to prevent heat buildup and allows long continuous operation.
- ④ Motor cord with quick disconnect.

3 SPECIFICATIONS AND DIMENSIONS

3-1 Specifications

Model	EM-3080J	EM-3080J-2M
Cord with Quick Disconnect	0.3m	2.0m
Allowable Motor Speed	80,000 min ⁻¹	
Max. Output	350W	
Weight	360g	530g
Noise Level	Less than 70dB(A)	

<Optional>

Motor Cord	Length 3.0m, 3.7m, 5.7m, 7.7m
*Note	(Air Hose : Provided)

*Note : Motor Cord is sold separately(Length 3.0m, 3.7m, 5.7m, 7.7m.).
Never select the arrange of EM-3080J-2M & Mortor Cord Length 7.7m For over the total length 8m,this may make any error condition.

Standard Equipment
Accessories

- Spanner (22 x 27)
- Operation Manual

3-2 Outside View

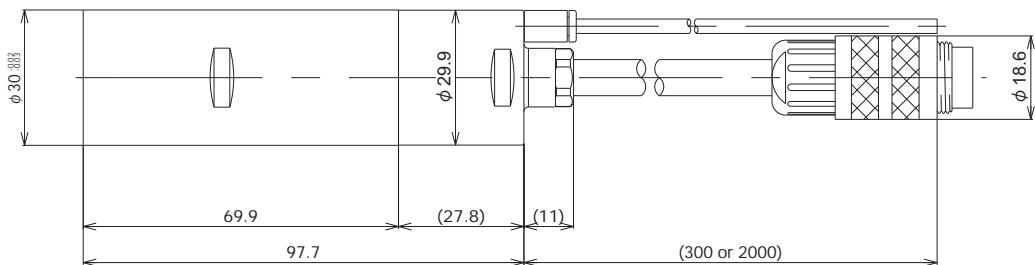

Fig. 1

4 TORQUE AND OUTPUT POWER CHARACTERISTIC GRAPH

EM-3080J / EM-3080J-2M

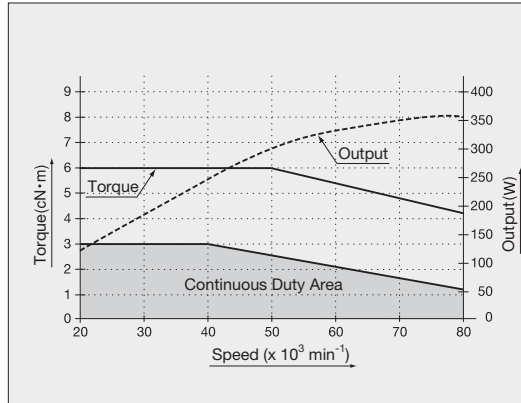

Fig. 2

5 CONNECTION OF MOTOR CORD

- Remove the protective cover from the motor cord by turning the end cap counterclockwise.

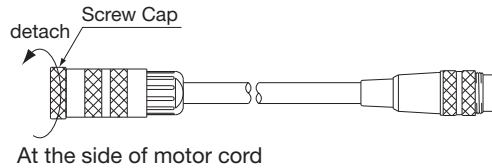

Fig. 3

- Align the convex (male) connector on the motor with the concave (female) on the motor cable. **Pay close attention to the alignment pins on the motor and cable. Insert the cable into the motor.**

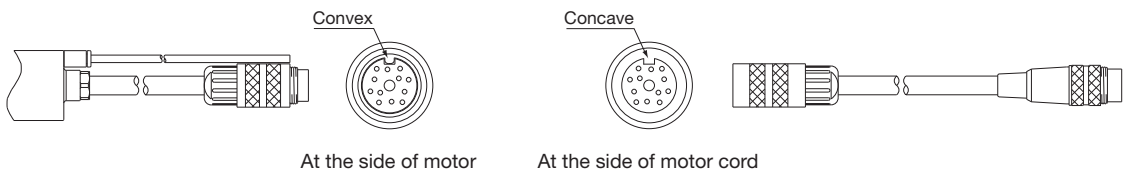

Fig. 4

Fig. 5

- Turn the cable nut on the end of the motor cable clockwise to draw the cable into the motor and tighten. **Pay close attention not to cross thread.**

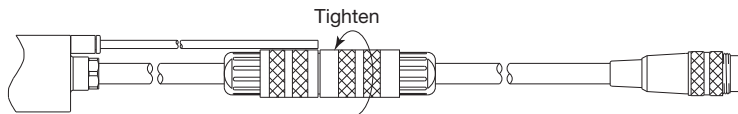

Fig. 6

- Remove the protective air inlet quick disconnect (slant part).



Fig. 7

- Insert the provided air hose.

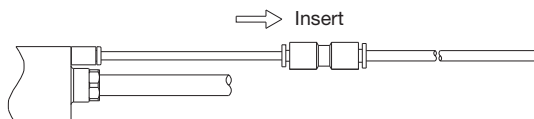

Fig. 8

⚠ WARNING

- ① When connecting the motor cord(optional) to the NE260 control unit and the control unit is ON, never insert or pull out the motor cord. This may cause electric shock.
- ② Connect the motor cord(optional) to the NE260 control unit correctly. This may cause leakage.
- ③ Be sure to connect the air hose to EM-3080J through the NE260 control unit or the NE261 selector unit. If not, this will cause the error of protect function.
- ④ Check that all hose connections are secure and strong to avoid accidental disconnection during operation.
- ⑤ Put on/off the motor cord(optional) and the air hose excessively.
The damage or deterioration will cause air leakage, hose disconnection and electric shock.

⚠ CAUTION

Always reinstall the protective motor and cable caps when not in use or in storage to prevent pin damage or foreign debris from entering the spindle or cable.

6 CONNECTION OF SPINDLE

Align the threads at the front end of the motor and the rear end of the spindle and turn the spindle clockwise. If the motor's drive shaft and the spindle's drive dog do not align properly, you will only be able to turn the spindle about 2 turns. DO NOT FORCE. Turn the spindle back, counterclockwise, slightly and rotate the spindle by hand to engage the drive assemblies and then screw them together tightly and fasten with the provided wrenches.

⚠ CAUTION

Make sure your hands and all interlocking parts of the spindle and motor are clean before connecting the motor to the spindle to prevent contaminants from entering the motor or spindle.

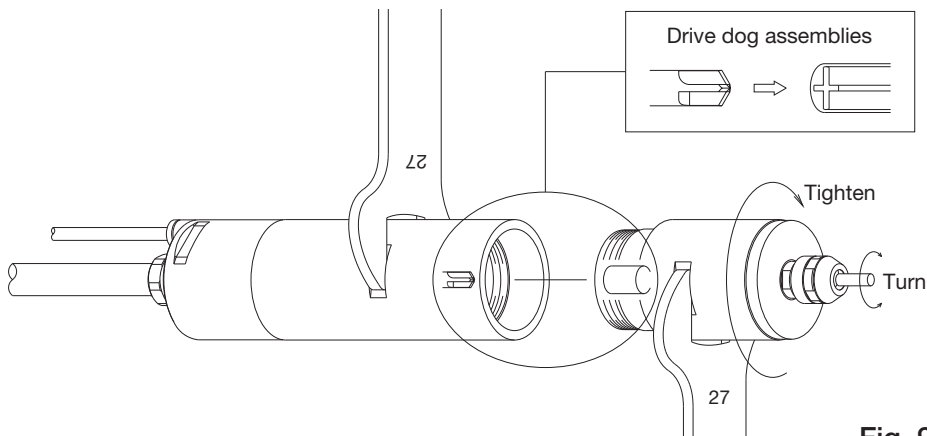

Fig. 9

7 TROUBLESHOOTING

Trouble	Cause	Inspect/Corrective Action
Noise or vibration during rotation	Contaminats inside Ball bearing. Ball bearing is worn.	Return for service.