

# Motor Spindle

## EM20-S6000 • EM25-S6000

## EM30-S6000

### OPERATION MANUAL

OM-K0449E 002

Thank you for purchasing this motor spindles. This motor spindle is designed for high precision machining including grinding, small diameter drilling and milling. The E3000 Control Unit and the Air Line Kit (AL-0201) are required to drive this motor spindle. Read this and the E3000 Control Unit and the Air Line Kit (AL-0201) Operation Manual carefully before use.

#### 1. CAUTIONS FOR HANDLING AND OPERATION

- Read these warnings and cautions carefully and only use in the manner intended.
- These warnings and cautions are intended to avoid potential hazards that could result in personal injury or damage to the device. These are classified as follows in accordance with the seriousness of the risk.

Class	Degree of Risk
<b>WARNING</b>	A safety hazard could result in bodily injury or damage to the device if the safety instructions are not properly followed.
<b>CAUTION</b>	A hazard that could result in light or moderate bodily injury or damage to the device if the safety instructions are not followed.

#### WARNING

- This motor spindle is not a hand tool. It is designed to be used on CNC machines or special purpose machines.
- Do not touch the cutting tool while it is running. It is very dangerous.
- Wear safety glasses, dust mask, and use a protective cover around the motor spindle whenever the motor spindle is rotating.
- Never touch the power cord with wet hands. This may cause an electric shock.
- Never operate or handle the motor spindle until you have thoroughly read the owner's manual and safe operation has been confirmed.
  - To prevent injuries/damages, check this motor spindle and cutting tool for proper installation, then operate this motor spindle.
  - Before disconnecting the spindle, always turn the control power off and turn the compressed air supply to the control unit off. Then it is safe to remove the motor spindle.
- When installing a tool, tighten the collet chuck correctly and check again the collet chuck and chuck nut before use. Do not over tighten the collet chuck. This may cause damage to the motor spindle.
- Do not use bent, broken, chipped, out of round or sub-standard tools as they may cause shatter or explode. The tool with cracked, bended may cause some injury to operator. When using a new tool, rotate it in a low speed and increase speed gradually for safety.
- Do not exceed the maximum recommended allowable tool speed. For your safety, use speeds below the maximum allowable speed.
- Do not apply excessive force. This may cause tool slippage, tool damage, injury to the operator, loss of concentricity and precision.

#### CAUTION

- Do not drop or hit this motor spindle, as shock can damage to the internal components.
- Be sure to clean the collet chuck and chuck nut, the inside of the spindle before replacing the tool. If ground particles or metal chips stick to the inside of spindle or the collet chuck, damage to the collet chuck or spindle can occur due to the loss of precision.
- When cleaning a spindle, stop the motor and remove dirt with a brush or a cloth. Do not blow air to a dust proof cover area (refer to Section 3 - 2 "Outside view") with compressed air, foreign particles or cutting chips might get into the ball bearing.
- Always clean the tool shank before installing the tool in the spindle.
- When sizing the correct collet chuck size to the tool shank diameter, a tolerance of +0 ~ -0.01mm is strongly recommended. A tool shank within the +0 ~ -0.1mm range is mountable, however, this may cause poor concentricity and or insufficient tool shank gripping force.
- Select suitable products or tools for all applications. Do not exceed the capabilities of the spindle or tools.
- Carefully direct coolant spray to the tool. Do not spray directly on the motor spindle body.
- Stop working immediately when abnormal rotation or unusual vibration are observed. Afterwards, please check the content of Section 10 "TROUBLESHOOTING".
- Always check if the tool, collet chuck or chuck nut are damaged before and after operating.
- If the collet chuck or chuck nut show signs of wear or damage, replace them before a malfunction or additional damage occurs.
- After installation, repair, initial operation, or long periods of non operation, please refer to Section 8. "BREAK-IN PROCEDURE" detailed in Table 1. When checking the motor spindle, no vibration or unusual sound should be observed during rotation.
- Do not disassemble, modify or attempt to repair this motor spindle. Additional damage will occur to the internal components. Service must be performed by NSK NAKANISHI or an authorized service center.
- When using this motor spindle for mass production, please purchase the another motor spindle as a spare in case of an emergency.

#### 2. FEATURES

- The motor spindle housing is made from precision ground, hardened, stainless steel (SUS) with an outside diameter of  $\phi 20 \cdot 25 \cdot 30$ mm.
- Excellent durability and high reliability are obtained using a high-speed brushless motor, which eliminate the nuisance of brush replacement and maintenance.
- Easy to be attached to NC lathe or to replace the motor, because the connector is placed at the edge of the motor.
- Various sizes of collet chucks are available CHA 0.5mm-4.0mm or CHK 0.5mm-6.0mm. Standard collet chuck is 3.0mm (CHA/CHK) or 3.175mm (CHA/CHK). (For U.S. market 3.175mm (CHA/CHK).)

#### 3. SPECIFICATIONS AND DIMENSIONS

##### 3 - 1 Specification

Model	EM20-S6000	EM25-S6000	EM30-S6000
Allowable Motor Speed	60,000min <sup>-1</sup>		
Spindle Accuracy	Within 1 $\mu$ m		
Outside diameter	$\phi 20$ mm	$\phi 25$ mm	$\phi 30$ mm
Max. Output	250W	250W	350W
Weight	230g	375g	575g

Standard Accessories (EM20-S6000 / EM25-S6000)	
• Collet Chuck $\phi 3.0$ mm (CHA-3.0) or $\phi 3.175$ mm (CHA-3.175) • • 1pc.	• Wrench (9 × 11) • • 1pc.
• Chuck Nut (CHN-A) • • 1pc.	• Operation Manual • • 1set.
• Wrench (8 × 5) • • 1pc.	
Standard Accessories (EM30-S6000)	
• Collet Chuck $\phi 3.0$ mm (CHK-3.0) or $\phi 3.175$ mm (CHK-3.175) • • 1pc.	
• Chuck Nut (K-265) • • 1pc.	• Operation Manual • • 1set.
• Wrench (12 × 14) • • 2pcs.	

※ The collet chuck and chuck nut are attached to the spindle.

<Option>

Motor Cord *Note1	4m, 6m, 8m (The Air Hose ( $\phi 4$ mm) of the same length is attached.)
Collet Chuck (CHA- □□ ) (EM20-S6000/EM25-S6000)	$\phi 0.5$ mm - $\phi 4.0$ mm in 0.1mm increments and Standard inch size $\phi 2.35$ mm, $\phi 3.175$ mm
Collet Chuck (CHK- □□ ) (EM30-S6000)	$\phi 0.5$ mm - $\phi 6.0$ mm in 0.1mm increments and Standard inch size $\phi 2.35$ mm, $\phi 3.175$ mm, $\phi 6.35$ mm

\*Note1 : Motor Cord is sold separately.

Please select the suitable motor cord length for your application.

##### 3 - 2 Outside View

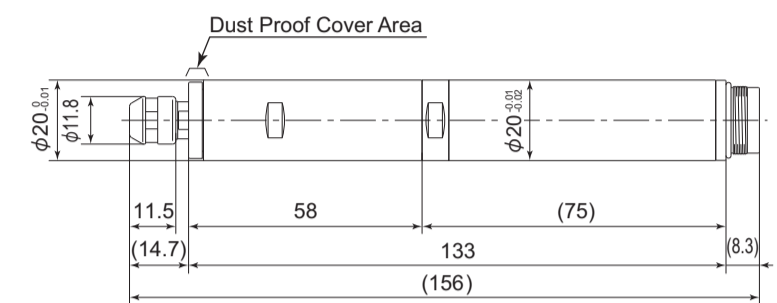

Fig. 1 EM20-S6000

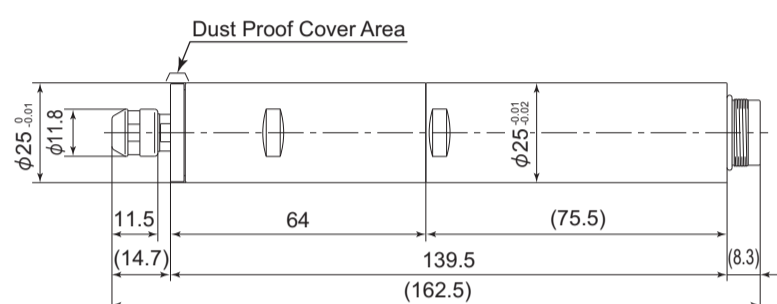

Fig. 2 EM25-S6000

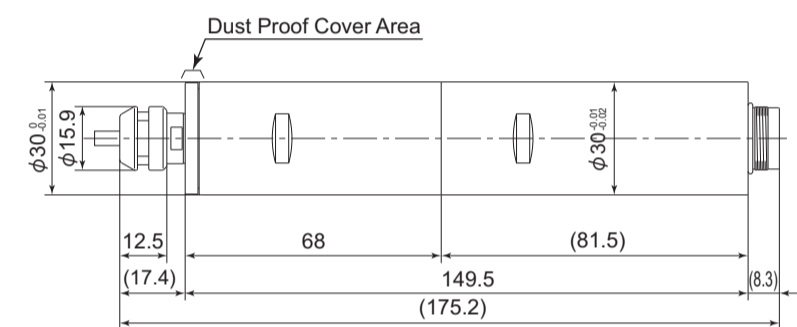

Fig. 3 EM30-S6000

##### 3 - 3 Torque Characteristics

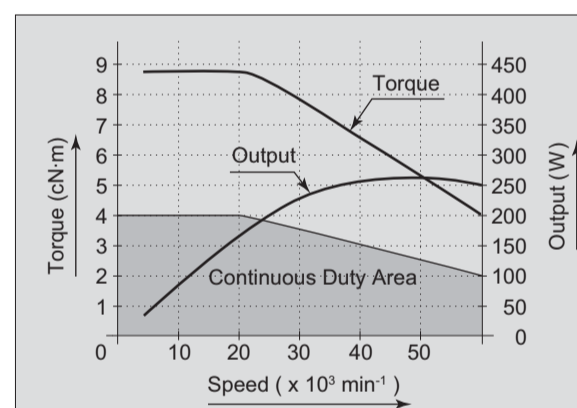

Fig. 4 EM20-S6000 / EM25-S6000

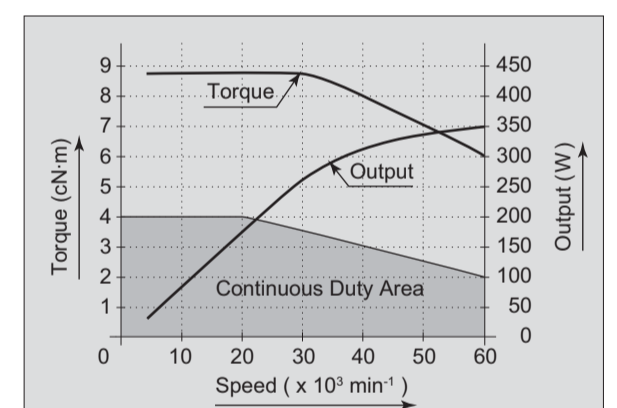

Fig. 5 EM30-S6000

#### 4. CHANGING THE TOOL

##### CAUTION

Do not tighten the collet chuck without inserting a tool or dummy bur, as this will damage the collet chuck, spindle or chuck nut, causing difficulty remove the collet chuck.

- Set the provided wrench (EM20-S6000/EM25-S6000 : 8mm, EM30-S6000 : 12mm) on the spindle.
- Place the provided wrench (EM20-S6000/EM25-S6000 : 11mm, EM30-S6000 : 14mm) on the chuck nut and turn it counterclockwise to loosen the collet chuck and remove the tool. (The first turn will loosen the chuck nut, but the tool will not release and turning will become stiff. Keep turning through the stiffness and the collet chuck will open.)
- Insert the new tool and tighten the collet chuck by turning clockwise.

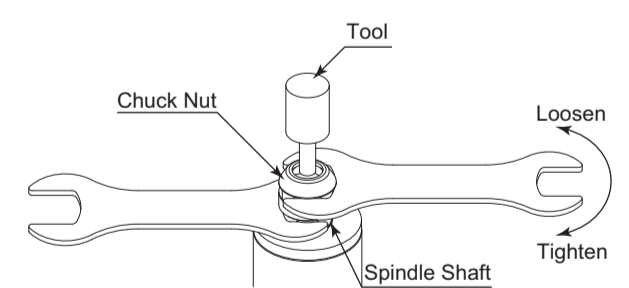

Fig. 6

#### 5. REPLACING THE COLLET CHUCK

- Remove the tool according to Section 4 "CHANGING THE TOOL" procedure above and remove chuck nut assembly. (Fig. 7)
- Place the provided wrench (EM20-S6000/EM25-S6000 : 8mm, EM30-S6000 : 12mm) on the spindle shaft, and hold the tool in the collet chuck. Turn it counterclockwise and remove the collet chuck. (Fig. 7)
- Install a new collet chuck in the chuck nut by positioning the collet chuck in the chuck nut and pressing down on a flat surface. (Fig. 8)

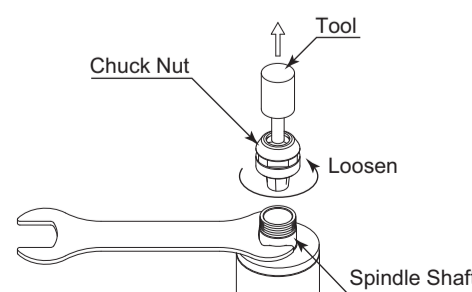

Fig. 7

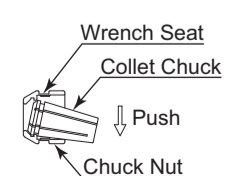

Fig. 8

## 6. CONNECTION OF THE MOTOR CORD

### CAUTION

Install the protective cap to prevent damage or contamination to the motor cord's connector when not in use.

- Remove the protective cap from the motor cord by turning the end of cap.

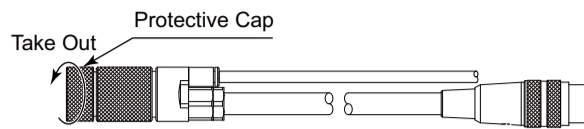

Fig 9

- Ensure alignment pin A and alignment hole B are upward. Carefully insert the alignment pin A into the alignment hole B and push straight into the motor lead port.

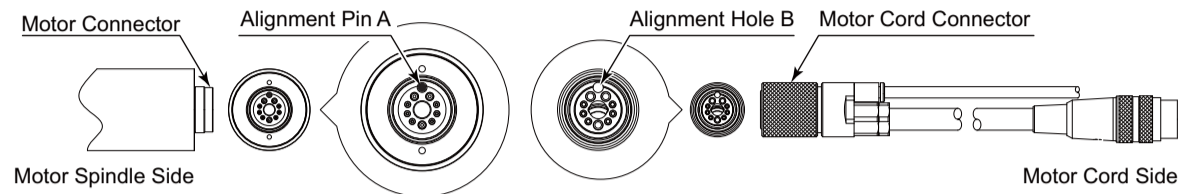

Fig 10

- Turn the motor cord nut clockwise to fasten according to Fig. 11.

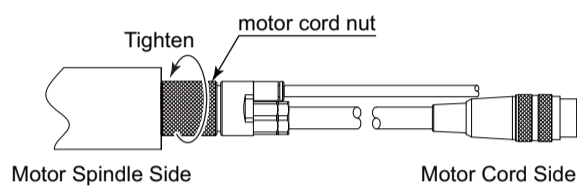

Fig 11

## 7. INSTALLATION OF THE MOTOR SPINDLE

### WARNING

When installing a motor spindle to a fixed base, make sure the fixed base is grounded in order to avoid the risk of an electric shock.

### CAUTION

- When installing a motor spindle, do not hit, drop or cause shock to the motor spindle. This may cause damage to internal components and result in malfunctions.
- If the motor spindle is installed incorrectly, this will cause and damage to the motor spindle.

- When mounting the motor spindle, refer to the Clamping Area etched on the motor spindle. (Fig. 12)

Model	D1	D2
EM20-S6000	18	34
EM25-S6000	22	30
EM30-S6000	20	36

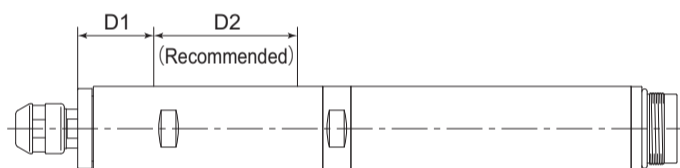

Fig 12

- The installation shown in Fig. 13 is the recommended installation method. If this is not possible, install as shown in Fig. 14. Do not allow set screws to come directly in contact with the motor spindle body as shown in Fig. 15, as this will result in damage to the motor spindle housing and internal components. When installing, never clamp directly over the bearings, as this will result in bearing damage.

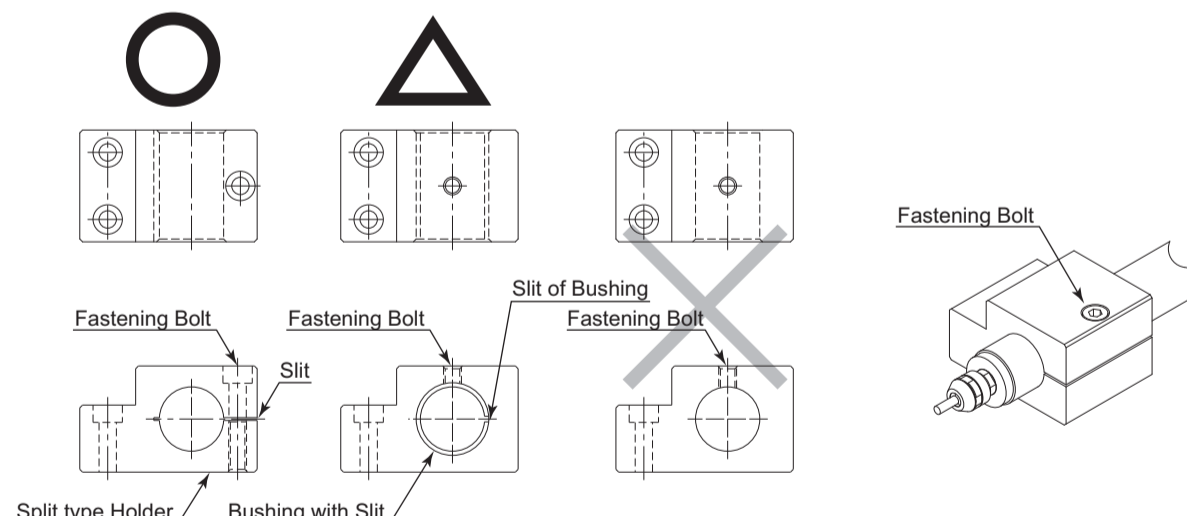

Fig 13

Fig 14

Fig 15

### CAUTION

- Cautions when tightening the securing bolt
  - Do not over tighten the bolt. This may cause damage to motor spindle's precision.
  - Tighten the bolt until the motor spindle body can not be turn by hand within the fixture.
  - Extreme tightening is not necessary or recommended.
  - Apply working force and check that the motor spindle is tight before using.

## RECOMMENDATIONS

- Advice when using split type holders and all similar types installation methods
  - Insert a shim into the holder bore, and tighten the bolt with minimal torque.
  - Manufacture the holder with roundness and cylindrical tolerance of less than 5µm.
  - Insert a thin shim into the split in the holder and reduce the shim size in 5µm increments until spindle is held firmly.
  - Tighten the clamping bolt to the torque specified for that size and type of bolt.
  - The final responsibility for ensuring product's stability for use in a given application is left to the designer of the equipment in which NAKANISHI's motor spindle is installed.
  - NAKANISHI offers motor spindles with a wide variety of capabilities and specifications.
  - Please carefully check the motor spindle's specifications against the requirements of your application and verify suitability and safety prior to initial use.

## 8. BREAK-IN PROCEDURE

During transportation, storage or installation the grease inside the bearings will settle. If the motor spindle is suddenly run at high-speed excessive heat will cause bearing damage. After installation, repair, initial operation, or long periods of non operation please follow the breakin procedure detailed in Table 1.

Table 1.

Steps	1	2	3	4	5
Rotation Speed (min <sup>-1</sup> )	15,000	30,000	40,000	50,000	60,000
Rotation Time (min)	15	10	10	10	10
Items to Check	No Abnormal Noises	Spindle Housing no hotter than 20°C. If hotter than 20°C stop for at least 20 minutes, check installation and restart Break-In procedure.			Spindle Housing less than 20°C.

## 9. CAUTIONS IN USING GRINDSTONES AND CUTTING TOOLS

### CAUTION

The maximum surface speed or rpm is always specified for a grindstone. Do not exceed the maximum speed with reference to the calculating chart below. Always follow the grindstone manufacturers recommendations.

$$\text{Surface Speed (m/min)} = \frac{3.14 \times \text{Diameter (mm)} \times \text{Rotation Speed (min}^{-1}\text{)}}{1,000}$$

- The proper surface speed for general grindstones is 600-1,800m/min.
- Do not exceed 13mm of overhang for mounted grindstones as shown in Fig. 16. If the overhang must exceed 13mm, reduce the motor speed in accordance with Table 2.
- Dress the grindstone prior to use.
- Do not use cutting tools with bent or broken shanks, cracks or excessive run-out.
- For grinding, the maximum depth of cut should not exceed 0.01mm radially or axially. Reciprocate the tool several times after each pass to eliminate tool pressure.
- Always operate tools within the allowable recommended speed of the tools. Use of a tool outside of the allowable speed of the tools could cause damage to the spindle and injury to the operator.
- Keep the tool shank and collet chuck clean. If contaminants are left in the collet chuck or chuck nut, excessive run-out will cause damage to the tool and or spindle.
- Do not strike or disassemble the motor spindle.
- Please set the tools to minimize the overhang amount. 13mm is the maximum amount of overhang to maintain high accuracy and safety.

Table 2. Overhang and Speed

Overhang (mm)	Max. Speed (min <sup>-1</sup> )
20	N x 0.5
25	N x 0.3
50	N x 0.1

N=Max. Operating Speed with 13mm overhang.

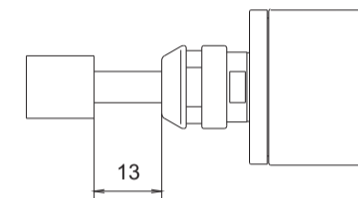

Fig. 16

## 10. TROUBLESHOOTING

If a problem or concern occurs, please check the following prior to consulting your dealer.

Trouble	Cause	Inspection/Corrective Action
Spindle does not run.	The ball bearings are damaged.	Replace the ball bearings. (Return to NAKANISHI dealer service.)
	Motor is broken.	Replace the motor. (Return to NAKANISHI dealer service.)
Overheating during rotation.	Cutting debris has contaminated the ball bearing, and the ball bearing is damaged.	Replace the ball bearings. (Return to NAKANISHI dealer service.)
	Low air pressure.	Check air hose connection and air pressure.
Abnormal vibration or noise during rotation.	Using bent tool.	Replace the cutting tool.
	Cutting debris has contaminated the ball bearing.	Replace the ball bearings. (Return to NAKANISHI dealer service.)
The ball bearings are worn.		
Tool slippage.	Collet chuck or chuck nut are not correctly installed.	Check and clean the collet chuck and chuck nut. And, tighten the collet chuck accurately again.
	The collet chuck is worn.	Replace the collet chuck.
High run-out.	The cutting tool is bent.	Change the cutting tool.
	Chuck nut is not correctly installed.	Secure the collet chuck and the chuck nut correctly.
	The collet chuck is worn.	Replace the collet chuck.
	Inside of the spindle is worn.	Replace the spindle shaft. (Return to NAKANISHI dealer service.)
	Contaminants inside the collet chuck or the spindle.	Clean the collet chuck and the inside of the spindle.
	The ball bearings are worn.	Replace the ball bearings. (Return to NAKANISHI dealer service.)

※Specifications may be changed without notice.

**NAKANISHI INC.**  
www.nakanishi-inc.com

700 Shimohinata Kanuma-shi  
Tochigi 322-8666,  
Japan

**NSK Europe GmbH** EC REP  
www.nsk-europe.de

Elly-Beinhorn-Strasse 8  
65760 Eschborn,  
Germany

**NSK America Corp**  
www.nskamericacorp.com

700 Cooper Court  
Schaumburg, IL 60173,  
USA