

# Motor Spindle EMS-3060A

## OPERATION MANUAL

OM-K0541E

Thank you for purchasing EMS-3060A ultra-precision, high speed electric motor/spindle. This motor/spindle is designed for high precision machining including grinding, small diameter drilling and milling. Read this operation manual carefully before use to ensure years of trouble-free operation.

### 1 CAUTIONS FOR HANDLING AND OPERATION

- Read these cautions carefully and only use in the manner intended.
- Safety instructions are intended to avoid potential hazards that could result in personal injury or damage to the device. Safety instructions are classified as follows in accordance with the seriousness of the risk.

Class	Degree of Risk
<b>⚠ WARNING</b>	A hazard that could result in bodily injury or damage to the device if the safety instructions are not followed.
<b>⚠ CAUTION</b>	A hazard that could result in light or moderate bodily injury or damage to the device if the safety instructions are not followed.

#### ⚠ WARNING

- ① The EMS-3060A is not designed for hand use. Install it on a machine like a special purpose machine or an NC lathe.
- ② Do not touch the spindle while it is running.
- ③ Wear safety glasses, dust mask and hearing protection, and use a protective cover around the spindle whenever spindle is operating.
- ④ Check the chuck tightness before each use.
- ⑤ Do not apply excessive force. This may cause tool slippage or tool damage.
- ⑥ Do not exceed the maximum allowable tool speed. For your safety, use tools below the maximum allowable speed.
- ⑦ Do not use bent, broken, chipped, out of round or sub-standard tools. They can shatter or explode, and may cause injury.

#### ⚠ CAUTION

- ① Do not drop or hit the spindle because shock can damage the internal components.
- ② Always clean the chuck. If ground particles or metal chips stick to the inside of spindle or the chuck, this will cause damage to the chuck or spindle and loss of precision.
- ③ Always clean the tool shank before installing in the spindle.
- ④ Do not disassemble, modify or attempt to repair the motor spindle as it will damage internal components and there are no user serviceable parts, so it can't be repaired.
- ⑤ Do not over tighten the chuck. This may cause spindle damage.
- ⑥ Select suitable products or tools for the applications. Do not exceed the capabilities of the spindles or cutting tools.
- ⑦ Stop working immediately when abnormal rotations or unusual vibration are observed.
- ⑧ Carefully direct coolant spray to the cutting tool. Do not spray directly on the spindle body.
- ⑨ Use only tools with shank diameter tolerance similar to the chuck I.D. tolerance.
- ⑩ Check if tools, chucks or chuck nuts are damaged before working.
- ⑪ The collet chuck has been ever outlived its usefulness. Need to be exchanged in case of its malfunction or damage.
- ⑫ When using this spindle for mass production, please purchase the another spindle for spare in case of an emergency.

### 2 FEATURES

- ① The spindle housing is made from precision ground, hardened, stainless steel (SUS-420) with an outside diameter of  $\phi 30$ mm.
- ② Excellent durability and high reliability are obtained using a high-speed brushless motor, which eliminate the nuisance of brush replacement and maintenance.
- ③ Easy to detach the motor spindle, the cord with quick disconnect is attached.

### 3 SPECIFICATIONS & DIMENSIONS

#### 3-1 Specifications

Model	EMS-3060A
Allowable Motor Speed	60,000 min <sup>-1</sup>
Spindle Accuracy	Within 1 $\mu$ m
O.D. of Motor Spindle	$\phi 30$ mm
Max. Output	350W
Weight	495g

<Optional>

Motor Cord	Length 3.7m, 5.7m, 7.7m
*Note	(Air Hose : Provided)
Collet Chuck (CHA-□□)	$\phi 0.5$ mm- $\phi 4.0$ mm in 0.1mm increments and $\phi 2.35$ mm, 3.175mm
*Note	

\*Note : Collet Chuck and Motor Cord are sold separately.

#### Standard Equipment Accessories

- Chuck Nut (CHN-A).....provided
- Air Hose 0.3m
- Spanner (8 x 5)
- Spanner (9 x 11)
- Operation Manual

#### 3-2 Outside View

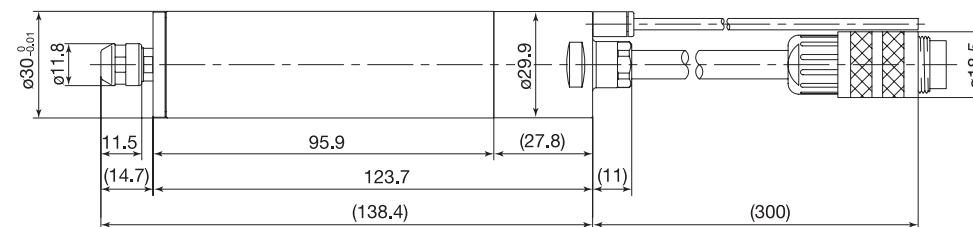

Fig. 1

#### 3-3 Torque Characteristics

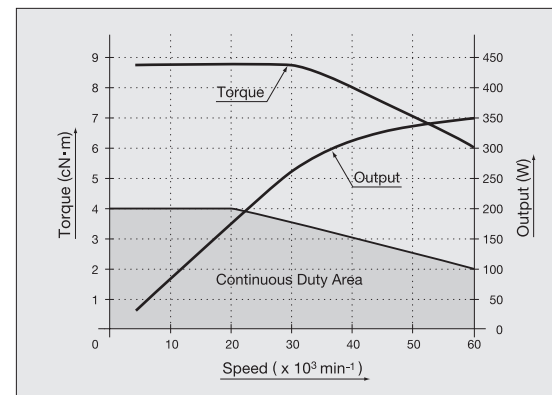

Fig. 2

### 4 CHANGING TOOLS

- ① Set the provided 8mm wrench on the spindle.
- ② Place the provided 11mm wrench on the chuck nut and turn it counterclockwise to loosen the collet and remove the cutting tool. (The first turn will loosen the chuck nut, but the tool will not release and turning will become stiff. Keep turning through the stiffness and the collet will open.)
- ③ Insert the new tool and tighten the collet by turning clockwise.

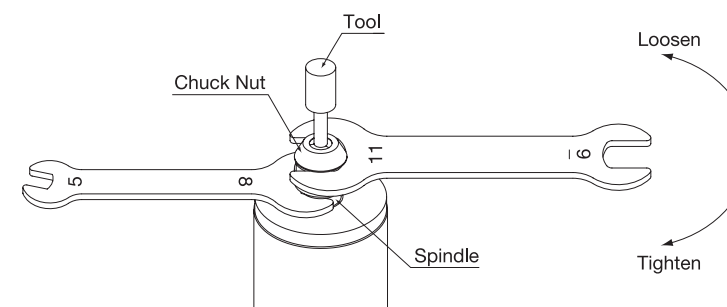

Fig. 3

#### ⚠ CAUTION

Tightening the chuck nut with no cutting tool in the chuck nut may over-tighten the chuck, and damage the spindle.

## 5 REPLACING THE COLLET

- Remove the cutting tool according to “4 CHANGING TOOLS” procedure above and remove chuck nut assembly. (Fig. 4)
- Place the spanner 8mm provided on the spindle shaft, and hold the cutting tool in the collet. Turn it counterclockwise and remove the collet.
- Install a new collet in the spindle shaft by positioning the collet in the spindle shaft and pressing down on a flat surface.

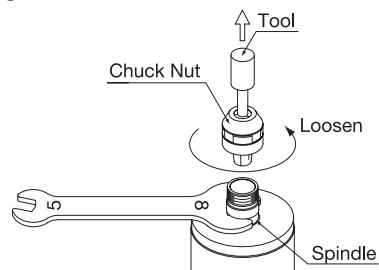

Fig. 4

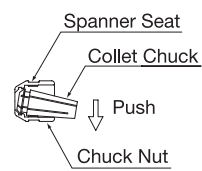

Fig. 5

## 6 CONNECTION OF MOTOR CORD

- Remove the protective cover from the motor cord by turning the end cap counterclockwise.

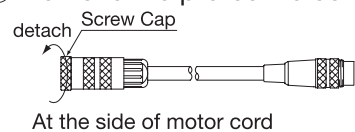

Fig. 6

- Align the convex (male) connector on the EMS-3060A spindle with the concave (female) on the motor cable. Pay close attention to the alignment pins on the motor and cable. Insert the cable into the motor.

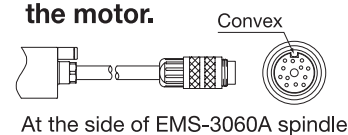

Fig. 7

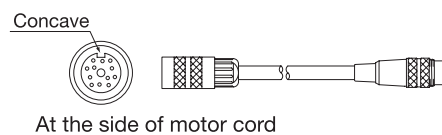

Fig. 8

- Turn the cable nut on the end of the motor cable clockwise to draw the cable into the motor and tighten. Pay close attention not to cross thread.

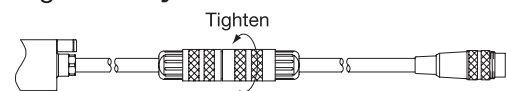

Fig. 9

- Remove the protective air inlet quick disconnect (slant part).



Fig. 10

- Insert the provided air hose between the motor and motor cable quick disconnects.

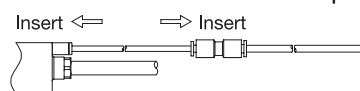

Fig. 11

### CAUTION

Always reinstall the protective motor and cable caps when not in use or in storage to prevent pin damage or foreign debris from entering the spindle or cable.

## 7 INSTALLATION OF MOTOR AND SPINDLE

- When mounting the spindle avoid the area where bearings are located. If the spindle is mounted inappropriately, this will cause damage to the spindle. (Refer to the recommended clamping area drawing in Fig. 12)

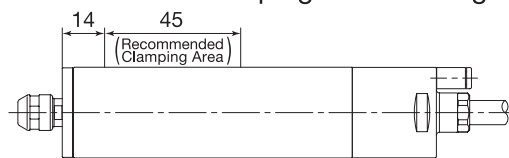

Fig. 12

- The installation shown in Fig. 13 is the recommended installation method. Therefore, the installation as shown in Fig. 13 is the most recommended. (In case the above is impossible, install as shown in Fig. 14) When installing a spindle, it is not recommended to fix the spindle with a fastening bolt in direct contact with the spindle body as shown in Fig. 15. This can cause deformation of the spindle body and damage internal components.

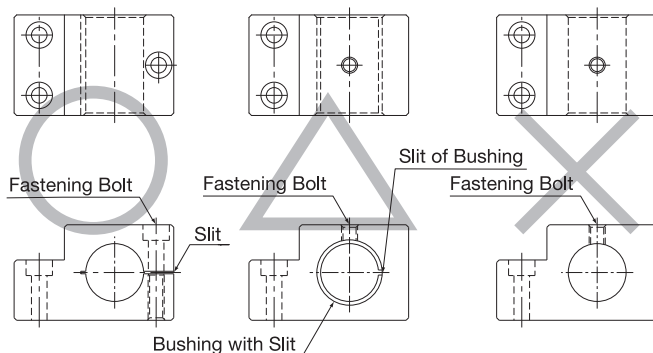
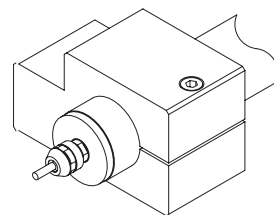

Fig. 13

Fig. 14

Fig. 15



### WARNING

When installing a motor/spindle to fixed base, make sure the fixed base is grounded in order to avoid the risk of an electric shock.

### CAUTION

- Caution about tightening the bolt**  
Do not over tighten the bolt. This may cause damage to the spindle's precision. Tighten the bolt until the spindle body can not be turned by hand within the Fixture. Apply working force and check that the spindle is tightened before use.
- Caution about bushing type Holder**  
Insert a shim to the holder bore, and tighten the bolt with the regulated torque. Manufacture the holder with roundness and cylindrical tolerance of less than 5μm. Insert a thin shim into the split in the holder to maintain the split gap at 5μm (Reference value) and tighten the clamping bolt to the torque specified for that size and type of bolt.  
The final responsibility for ensuring a product's suitability for use in a given application is left to the designer of the equipment in which NAKANISHI's spindle is installed. NAKANISHI offers spindles with a wide variety of capabilities and specifications. Please carefully check the product's specifications against the requirements of your application and verify suitability and safety prior to initial use.

## 8 CAUTION IN HANDLING TOOLS

- The proper surface speed for vitrified grindstones is 600-1800m/min.

### CAUTION

Do not exceed a surface speed of 2,000m/min for grinding.

$$\text{Surface Speed (m/min)} = \frac{3.14 \times \text{Diameter (mm)} \times \text{rotation speed (min}^{-1}\text{)}}{1000}$$

- Do not exceed 13mm overhang for mounted grindstones. In case overhang must exceed 13mm reduce the motor speed in accordance with Fig. 16.
- Do not use tools with bent or broken shanks, cracks or excessive runout.
- Dress the grindstone prior to use.
- For grinding the maximum depth of cut should not exceed 0.01mm radially or axially. Reciprocate the tool several times after each in feed step.
- Always operate tools within the tool manufacturer's recommended speed limits. Use of a tool outside of the manufacturer's recommended speed limits could cause damage to the spindle and injury to the operator.
- Keep the tool shank and collet clean. If contaminants are left in the collet they can cause excessive runout and damage the tool and spindle.
- Do not strike or disassemble the spindle.

Table 1. Overhang and Speed

Overhang (mm)	Speed (min <sup>-1</sup> )
20	N x 0.5
25	N x 0.3
50	N x 0.1

N=Max. operating speed at 13mm overhang

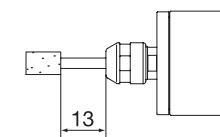

Fig. 16

## 9 TROUBLESHOOTING

When the trouble is found, please check the following prior to consulting your dealer.

Trouble	Cause	Inspect / Corrective Action
Tool Slippage	Contaminants inside the chuck or the spindle.	Clean the inside of the chuck and the spindle.
	Chuck Nut is not properly positioned.	Set the chuck the chuck nut properly.
	Cutting tool is bent.	Replace cutting tool.
Noise or vibration during rotation	Ground Particles stuck in the air of Ball Bearing.	Send to NAKANISHI repairs.
	Bent tool.	Change the tool.