

# 90° Mini-Angle Attachment MFC - 300 (M<sub>Type</sub> • S<sub>Type</sub>)

## OPERATION MANUAL

OM-K0195E 003

Thank you for purchasing the 90° Mini-Angle Attachment " MFC - 300 ". This Attachment designed for small hole ID finishing and deburring.

The Emax EVolution Control Unit, Brushless Motor or ROTUS Air Motor / Air Line Kit are required to drive this Attachment. Read this and all the associated component Operation Manuals carefully before use. Always keep this Operation Manual in a place where a user can referred to for reference at any time.

### 1. CAUTIONS FOR HANDLING AND OPERATION

- Read these warnings and cautions carefully and only use in the manner intended.
- These warnings and cautions are intended to avoid potential hazards that could result in personal injury to the operator or damage to the device. These are classified as follows in accordance with the seriousness of the risk.

Class	Degree of Risk
<b>WARNING</b>	A safety hazard could result in bodily injury or damage to the device if the safety instructions are not properly followed.
<b>CAUTION</b>	A hazard that could result in light or moderate bodily injury or damage to the device if the safety instructions are not followed.

#### **WARNING**

- ① This Attachment is designed for hand use. Never install this Attachment or any hand cutting tool on a machine such as a special purpose machine, NC lathe or mill.
- ② Do not exceed the " Maximum Motor Rotation Speed " (Refer to " 6 - 1 Specifications ").
- ③ Be sure to connect the reducer to the Attachment when using the Attachment.  
When not connecting the reducer to the Attachment may cause damage to the inside components and short life of the Attachment.
- ④ Do not touch the cutting tool while it is rotating. It is very dangerous.
- ⑤ Wear safety glasses, dust mask, and use a protective cover around the Attachment whenever the Attachment is rotating.
- ⑥ When installing a cutting tool, tighten the collet correctly and check again the collet before use. Do not over-tighten the collet. This may cause damage to the spindle.
- ⑦ Do not use grindstones with an outside diameter over  $\phi 40\text{mm}$ .
- ⑧ Do not exceed 13mm of overhang for mounted grindstones as shown in Fig. 1. If the overhang must exceed 13mm, reduce the motor speed in accordance with Table 1.
- ⑨ Do not use bent, broken, chipped, out of round or sub-standard cutting tools as they may cause shatter or explode.  
The cutting tool with cracked, bended may cause some injury to operator.  
When using a new cutting tool, rotate it in a low speed and increase speed gradually for safety.
- ⑩ Always operate cutting tools within the cutting tool manufacturer's recommended speed limits. Use of a cutting tool higher than the manufacturer's recommended speed limits could cause damage to the spindle and injury to the operator.
- ⑪ Do not apply excessive force. This may cause cutting tool slippage, cutting tool damage, injury to the operator, loss of concentricity and precision.

Table. 1 Overhang and Speed

Overhang (mm)	Max. Speed (min <sup>-1</sup> ) (rpm)
20	N x 0.5
25	N x 0.3
50	N x 0.1

\*N = Max. Operating Speed with 13mm overhang.

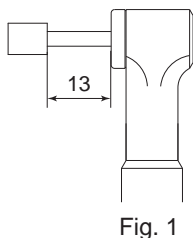

Fig. 1

#### **CAUTION**

- ① Do not drop or hit this Attachment, as shock can damage to the internal components.
- ② Be sure to clean the collet, the spindle taper and threads before replacing the cutting tool. If ground particles or metal chips stick to the inside of spindle or the collet, damage to the collet or spindle can occur due to the loss of precision.
- ③ When cleaning an Attachment, stop the motor and remove dirt with a brush or a cloth. Do not blow compressed air into the Attachment. Foreign particles or cutting chips may get into the ball bearings.
- ④ Always clean the cutting tool shank before installing the cutting tool in the spindle.

#### **CAUTION**

- ⑤ When sizing the correct collet size to the cutting tool shank diameter, a tolerance of  $+0 \sim -0.01\text{mm}$  is strongly recommended.  
A cutting tool shank within the  $+0 \sim -0.1\text{mm}$  range is mountable, however, this may cause poor concentricity and or insufficient cutting tool shank gripping force.
- ⑥ Select suitable products or cutting tools for each application. Do not exceed the capabilities of the Attachment or cutting tools.
- ⑦ Keep everything in order not to place the rag which could be caught near the hand tool.
- ⑧ Stop operating immediately when abnormal rotation or unusual vibrations are observed. Immediately, please check the content of section " 11. TROUBLESHOOTING ".
- ⑨ Always check if the cutting tool, collet is damaged before and after operating.
- ⑩ If the collet show signs of wear or damage, replace it before a malfunction or additional damage occurs.
- ⑪ No lubrication is required because grease impregnated ball bearings are used.
- ⑫ After installation, repair, initial operation, or long periods of non operation, please carry out break-in as follow. Start rotating slowly and over a short period of 5 - 10 minutes, increase speed gradually until allowable maximum speed.
- ⑬ Do not disassemble, modify or attempt to repair the Attachment. Additional damage will occur to the internal components. Service must be performed by NSK NAKANISHI or an authorized service center.

### 2. BASIC PACKAGE

When opening the package, check if it includes all items listed in " Table. 2 Packing List Contents ". In the event of any shortage, please contact either NAKANISHI (see the " 4. CONTACT US " section) or your local dealer.

Table. 2 Packing List Contents

Attachment • • 1pc. 	Collet* 	Chuck Wrench (K - 232) • • 1pc. 
Pin Wrench (K - 233) • • 1pc. 	Operation Manual • • 1set 	

\* M Type :  $\phi 1.6\text{mm}$  (K - 253) • • 1pc. S Type :  $\phi 1.6\text{mm}$  (K - 252) • • 1pc.  
The collet is attached to the Attachment.

### 3. WARRANTY

We provide a limited warranty for our products. We will repair or replace the products if the cause of failure is due to the following manufactures defects. Please contact us or your local distributor for details.

- ① Defect in manufacturing.
- ② Any shortage of components in the package.
- ③ Where damaged components are found when initially opening the package (This shall not apply if the damage was caused by the negligence of a customer).

### 4. CONTACT US

For your safety and convenience when purchasing our products, we welcome your questions. If you have any questions about operation, maintenance and repair of the product, please contact us.

#### **Contact Us**

- For U.S. Market

Company Name

: **NSK America Corp**  
Industrial Div.

Business Hours

: 8:30am to 17:00pm (CST)  
(closed Saturday, Sunday and Public Holidays)

U.S. Toll Free No.

: 800-585-4675

Telephone No.

: 847-843-7664

Fax No.

: 847-843-7622

Web Address

: [www.nskamericacorp.com](http://www.nskamericacorp.com)

- For Other Markets

Company Name

: **NAKANISHI INC.**

Business Hours

: 8:00am to 17:00pm  
(closed Saturday, Sunday and Public Holidays)

Telephone No.

: +81 (0) 289-64-3520

e-mail Address

: [webmaster-ie@nsk-nakanishi.co.jp](mailto:webmaster-ie@nsk-nakanishi.co.jp)

## 5. FEATURES

- ① MFC - 300M is the smallest 90° head available.
- ② Best for removing edges & burrs or correction of drilled holes inside small diameter holes.
- ③ MFC - 300 is an Attachment for grinding axis for deep holes of special purpose for shank diameter  $\phi 1.6\text{mm}$ .

## 6. SPECIFICATIONS AND DIMENSIONS

### 6 - 1 Specifications

Model	MFC - 300M	MFC - 300S
Maximum Motor Rotation Speed	Less than $15,000\text{min}^{-1}$ (rpm)	
Applicable Motor	ENK - 410S, ENK - 250T (Emax EVolution) IM - 300, IM - 301 (ROTUS)	
Vibration Level	Less than $2.5\text{m/s}^2$	
Weight	47g	50g
Noise Level at 1m distance	Less than 70dB (A)	

	Temperature	Humidity	Atmospheric Pressure
Operation Environment	0 - 40°C	MAX.75% (No condensation)	800 - 1,060hPa
Transportation and Storage Environment	-10 - 50°C	10 - 85%	500 - 1,060hPa

< Option >

Collet	K - 252, K - 253
--------	------------------

### ⚠ WARNING

Do not exceed the " Maximum Motor Rotation Speed " .

### 6 - 2 Outside View

① MFC - 300M

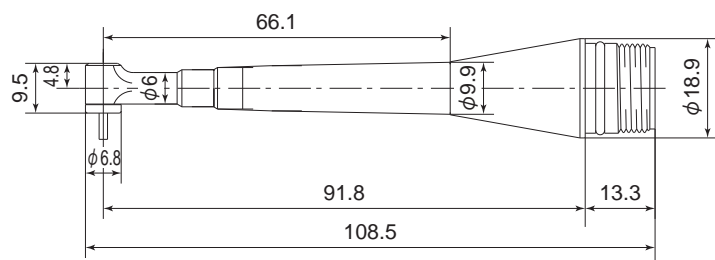

Fig. 2

② MFC - 300S

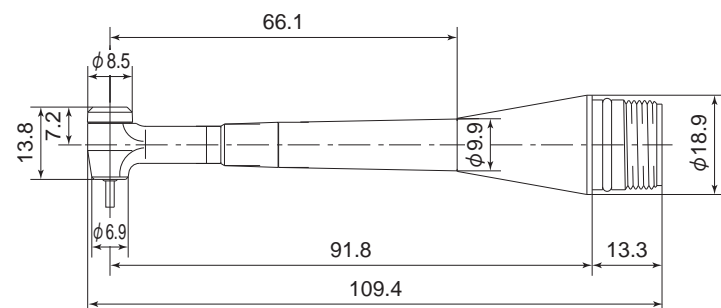

Fig. 3

## 7. CONNECTION OF THE ATTACHMENT TO THE MOTOR

### ⚠ CAUTION

Make sure your hands and all interlocking parts of the Attachment and motor are clean before connecting the Attachment to the motor. This is critical to preventing contaminants from entering the Attachment or motor.

Align the thread on the front end of the motor and the rear of the Attachment, and turn the Attachment clockwise. If the drive shaft of the motor does not engage properly to the drive dog on the Attachment, it may only turn approximately two threads before stopping. DO NOT FORCE THE TOGETHER. Loosen the Attachment from the motor, rotate the Attachment shaft by hand then re-try. The drive shaft and the drive dog must be fully engaged. When fully engaged, secure the motor and Attachment using the provided pin wrench (K - 233) (Fig. 4).

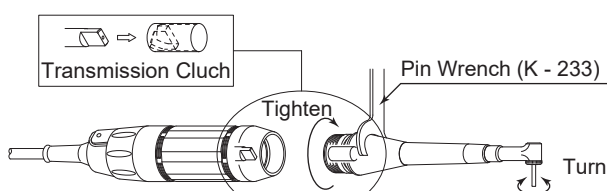

Fig. 4

## 8. CHANGING THE CUTTING TOOL

### ⚠ CAUTION

- Tool shank diameter  $\phi 1.6\text{mm}$ . NAKANISHI make a wide precision cutting tools. Please select from our " Micro grinder & Tools Catalogu " .
- Do not tighten the collet without inserting a cutting tool or dummy bur, as this will result in damage to the collet.

- ① Insert the chuck wrench into the back of the angle head and rotate the knob 1 / 4 turn to release the cutting tool.

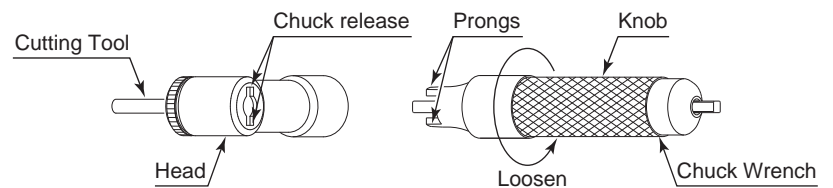

Fig. 5

- ② Insert a new cutting tool into the inside of the collet, and turn the knob of the chuck wrench clockwise to fix the cutting tool.

## 9. REPLACING THE COLLET

- ① Remove the cutting tool according to the section " 8. CHANGING THE CUTTING TOOL " procedure above.
- ② Insert clutch at the edge of the chuck wrench into the head counterpart of the Attachment. And turn the knob of the chuck wrench counterclockwise to remove the collet.

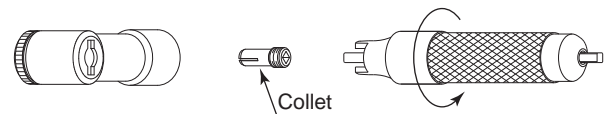

Fig. 6

- ③ Attach a new collet into the edge of the chuck wrench, and set the clutch of the chuck wrench to the head counterpart, make 4 - 5 turns of knob clockwise.
- ④ Insert the cutting tool into the inside of the collet, and turn the knob of the chuck wrench clockwise to fix the cutting tool.

## 10. APPLICATIONS

For example, enable for removing edges inside small diameter holes (Fig 7). If the shank of cutting tool for removing edges is cutting too long, attach the cutting tool to Attachment only after trimming to the appropriate length.

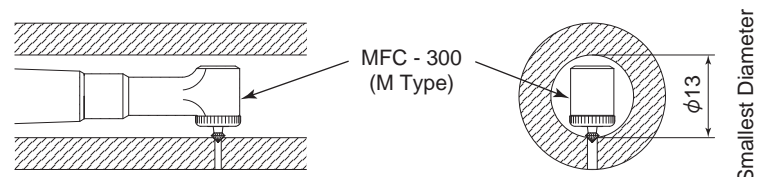

Fig. 7

## 11. TROUBLESHOOTING

If a problem or concern occur, please check the following items prior to consulting your dealer.

Trouble	Cause	Inspection / Corrective Action
Spindle does not rotate or rotate smoothly.	The spindle ball bearings have been damaged.	Replace the ball bearings. (Return to NAKANISHI dealer service.)
	The motor has been damaged.	Replace the motor. (Return to NAKANISHI dealer service.)
Overheating during rotation.	Cutting debris has contaminated the ball bearing, and the ball bearings are damaged.	Replace the ball bearings. (Return to NAKANISHI dealer service.)
Abnormal vibration or noise during rotation.	Using bent cutting tool.	Replace the cutting tool.
	Cutting debris has contaminated the ball bearings. The spindle ball bearings have been damaged.	Replace the ball bearings. (Return to NAKANISHI dealer service.)
Cutting tool slippage.	Collet is not correctly installed.	Check and clean the collet. Reinstall the collet and re-tighten. Check the accuracy.
	The collet is worn.	Replace the collet.
High run-out.	Cutting tool is bent.	Replace the cutting tool.
	The collet is worn.	Replace the collet.
	Inside of the spindle is worn.	Replace the spindle shaft. (Return to NAKANISHI dealer service.)
	Contaminants inside the collet or the spindle. The spindle ball bearings have been damaged.	Clean the collet and the inside of the spindle. Replace the ball bearings. (Return to NAKANISHI dealer service.)

In case of using a brushless motor, refer to the Emax EVolution Control Unit Operation Manual.

In case of using an air motor, refer to the ROTUS air motor and the Air Line Kit Operation Manuals.

## 12. DISPOSAL OF THE ATTACHMENT

When disposal of an Attachment is necessary, follow the instructions from your local government agency for proper disposal of industrial components.

NAKANISHI INC.

www.nakanishi-inc.com

700 Shimohinata, Kanuma, Tochigi 322-8666, Japan

Contents are subject to change without notice.

NSK America Corp

www.nskamericacorp.com

1800 Global Parkway, Hoffman Estates, IL 60192, USA