

Air Motor Spindle MSST - 23 Series

OPERATION MANUAL

OM-K0459E 003

Thank you for purchasing the Air Motor Spindle "MSST-23 Series". These Air Motor Spindles are designed for drilling, milling, and grinding with a NC lathe or special purpose machine. The Air Line Kit (with lubricator) and compressor are required to drive these Air Motor Spindles. Read this and all the associated component Operation Manuals carefully before use. Always keep this Operation Manual in a place where a user can refer to at any time.

1. CAUTIONS FOR HANDLING AND OPERATION

- Read these warnings and cautions carefully and only use in the manner intended.
- These warnings and cautions are intended to avoid potential hazards that could result in personal injury to the operator or damage to the device. These are classified as follows in accordance with the seriousness of the risk.

Class	Degree of Risk
WARNING	A safety hazard could result in bodily injury or damage to the device if the safety instructions are not properly followed.
CAUTION	A hazard that could result in light or moderate bodily injury or damage to the device if the safety instructions are not followed.

WARNING

- This Air Motor Spindle is not a hand tool. It is designed to be used on CNC machines or special purpose machines.
- Do not touch the cutting tool while it is running. It is very dangerous.
- Wear safety glasses, dust mask, and use a protective cover around the Air Motor Spindle whenever the Air Motor Spindle is rotating.
- Never operate or handle the Air Motor Spindle until you have thoroughly read the Operation Manuals and safe operation has been confirmed.
 - To prevent injuries / damages, check the Air Motor Spindle and cutting tool for proper installation, before operating the Air Motor Spindle.
 - Before disconnecting the Air Motor Spindle, always turn the control power off and turn the compressed air supply off. Then it is safe to remove the Air Motor Spindle.
- When installing a tool, tighten the collet chuck correctly and check again the collet chuck and chuck nut before use. Do not over-tighten the collet chuck. This may cause damage to the Air Motor Spindle.
- Do not use bent, broken, chipped, out of round or sub-standard tools, as this may cause them to shatter or explode. Tools with fractures or a bent shank will cause injury to the operator. When using a new tool, rotate it in a low speed and increase speed gradually for safety.
- Do not exceed the maximum recommended allowable tool speed. For your safety, use speeds below the maximum allowable speed.
- Do not apply excessive force. This may cause tool slippage, tool damage, injury to the operator or loss of concentricity and precision.



CAUTION



- Do not drop or hit this Air Motor Spindle, as shock can damage to the internal components.
- Before use, carefully read "Air Line Kit Operation Manual" regarding the correct connection, operation and cautions when using the Air Line Kit.
- Be sure to clean the collet chuck and chuck nut, the inside of the spindle before replacing the tool. If ground particles or metal chips stick to the inside of spindle or the collet chuck, damage to the collet chuck or spindle can occur due to the loss of precision.
- When cleaning a Air Motor Spindle, stop the Air Motor Spindle and remove debris with a soft brush or a cloth. Do not blow air into the dust proof cover area (refer to section "6 - 2 Outside View") with compressed air as foreign particles or cutting debris may get into the ball bearing.
- Always clean the tool shank before installing the tool in the Air Motor Spindle.
- When sizing the correct collet chuck size to the tool shank diameter, a tolerance of +0 ~ -0.01mm is strongly recommended. A tool shank within the +0 ~ -0.1mm range is mountable, however, this may cause poor concentricity and or insufficient tool shank gripping force.
- Operating the Air Motor Spindle in low Lubricant conditions will cause low rotation speed, damage to the internal components and shorter life of the Air Motor Spindle.
- Be sure to drain moisture and condensation from the Air Line Kit (air filter bowl) regularly to avoid moisture being carried to the Air Motor Spindle. This may cause damage to the Air Motor Spindle.
- Select suitable products or tools for all applications. Do not exceed the capabilities of the Air Motor Spindle or tools.
- Do not stop the Air Motor Spindle while coolant spray is being applied to the cutting tool. Removing the air pressure from the Air Motor Spindle causes a loss of purging, allowing the Air Motor Spindle to ingest coolant. This will cause damage to the Air Motor Spindle.
- Carefully direct coolant spray to the tool. Do not spray directly on the Air Motor Spindle body. If large amount spray directly on the Air Motor Spindle, it may cause excess load of the motor rotation with loss of durability to the Air Motor Spindle.
- Stop working immediately when abnormal rotation or unusual vibration are observed. Immediately, please check the content of section "13. TROUBLESHOOTING".
- Always check if the tool, collet chuck, chuck nut, connection hose and supply air / oil hose for damaged before and after operating.
- If the collet chuck or chuck nut show signs of wear or damage, replace them before a malfunction or additional damage occurs.
- After installation, repair, initial operation, or long periods of non operation, please carry out break-in as follow. Start rotating slowly and over a short period of 15 - 20minutes, increase speed gradually until allowable maximum speed.
- Do not disassemble, modify or attempt to repair this Air Motor Spindle. Additional damage will occur to the internal components. Service must be performed by NSK NAKANISHI or an authorized service center.
- When using this Air Motor Spindle for mass production, please consider the purchase of an additional Air Motor Spindle to be used as a back-up in case of emergency.
- Securely connect the compressor supply connection hose and the air / oil supply hose to the Air Line Kit and the Air Motor Spindle to avoid accidental disconnection during use.

2. BASIC PACKAGE

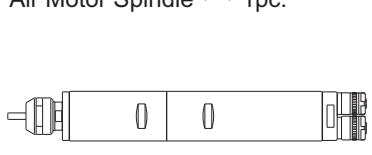
When opening the package, check if it includes all items listed in "Table.1 Packing List Contents". In the event of any shortage, please contact either NAKANISHI (see the "4. CONTACT US" section) or your local dealer.

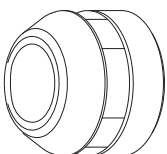
Table. 1 Packing List Contents

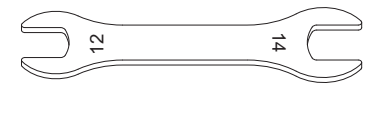
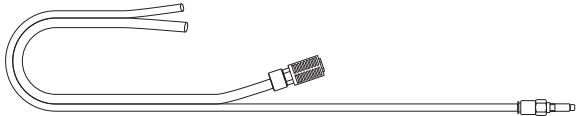
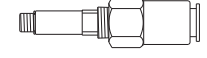
Air Motor Spindle • • 1pc.  MSST - 2330R Type	Collet Chuck ϕ 3.0mm (CHK - 3.0) or ϕ 3.175mm (CHK - 3.175) • • 1pc.* (For U.S. market ϕ 3.175mm (CHK - 3.175)) 	Chuck Nut (K - 265) • • 1pc.* 
---	--	--

Wrench (12 x 14) • • 1pc. 	Supply Air / Oil Hose (with Filter Joint), Exhaust Air / Oil Hose (with Silencer) R Type : K - 204 • • 1pc. (Double - barreled) RA Type : K - 215, K - 216 • • Each 1pc. 	K - 204
Joint • • 2pcs. (RA Type only) 	Inspection Card • • 1pc. 	Operation Manual • • 1set 

* The collet chuck and chuck nut are attached to the Air Motor Spindle.

< Filter Joint and Silencer suitable for Model >

Filter Joint	FJ - 01	RA Type
	FJ - 02	R Type
Silencer	K - 208	RA Type
	K - 209	R Type

3. WARRANTY

We provide a limited warranty for our products. We will repair or replace the products if the cause of failure is due to the following manufactures defects. Please contact us or your local distributor for details.

- Defect in manufacturing.
- Any shortage of components in the package.
- Where damaged components are found when initially opening the package.
(This shall not apply if the damage was caused by the negligence of a customer.)

4. CONTACT US

For your safety and convenience when purchasing our products, we welcome your questions. If you have any questions about operation, maintenance and repair of the product, please contact us.

Contact Us

- For U.S. Market

Company Name	: NSK America Corp
Industrial Div.	
Business Hours	: 8:30am to 17:00pm (CST) (closed Saturday, Sunday and Public Holidays)
U.S. Toll Free No.	: 800-585-4675
Telephone No.	: 847-843-7664
Fax No.	: 847-843-7622
Web Address	: www.nskamericacorp.com

- For Other Markets

Company Name	: NAKANISHI INC.
Business Hours	: 8:00am to 17:00pm (closed Saturday, Sunday and Public Holidays)
Telephone No.	: +81 (0) 289-64-3520
e-mail Address	: webmaster-ie@nsk-nakanishi.co.jp

5. FEATURES

- No heat is generated for long continuous use due to air driven operation.
- The Air Motor Spindle housing is made from precision ground, hardened, stainless steel (SUS) with an outside diameter of ϕ 23 mm.
- By mounting a silencer on the back exhaust air / oil hose, the quiet operation of air turbine is remarkably improved.
- Various sizes of collet chucks are available CHK - 0.5mm - 6.0mm. Standard collet chuck is CHK - 3.0mm or CHK - 3.175mm (For U.S. market CHK - 3.175mm).

6. SPECIFICATIONS AND DIMENSIONS

6 - 1 Specification

Model	MSST - 2330R	MSST - 2330RA	MSST - 2308R	MSST - 2308RA	MSST - 2302R	MSST - 2302RA
Maximum Motor Rotation Speed	30,000min ⁻¹ (rpm)	27,000min ⁻¹ (rpm)	8,000min ⁻¹ (rpm)	7,200min ⁻¹ (rpm)	2,000min ⁻¹ (rpm)	1,900min ⁻¹ (rpm)
Spindle Accuracy	Within 2 μ m					
Appropriate Air Pressure	0.3 - 0.5MPa (43.5 - 72.5psi)					
Air Consumption	190N ℓ /min (R), 170N ℓ /min (RA)					
Weight	328g	369g	415g	456g	405g	446g
Noise Level at 1m distance	Less than 70dB (A)					
Air hose Diameter	R Type	Supply Hose : O.D. ϕ 6.7 mm Length 2 m Exhaust Hose : O.D. ϕ 7.5 mm Length 1 m				
	RA Type	Supply Hose : O.D. ϕ 6.0 mm Length 2 m Exhaust Hose : O.D. ϕ 8.0 mm Length 1 m				
Operation Environment	Temperature 0 - 40°C		Humidity MAX.75% (No condensation)		Atmospheric Pressure 700 - 1,060hPa	
Transportation and Storage Environment	-10 - + 50°C		10 - 85%		500 - 1,060hPa	

< Option >

Collet Chuck (CHK - □□)	ϕ 0.5mm - ϕ 6.0mm in 0.1mm increments and ϕ 2.35mm, ϕ 3.175mm, ϕ 6.35mm
Chuck Nut	K - 265
Metal Saw Arbor (KCH - 03)	For I.D. ϕ 6mm x O.D. ϕ 30mm
Grindstone Arbor (AGM - 03)	For grinding wheel with I.D. of ϕ 5mm

6 - 2 Outside View

① MSST - 2330

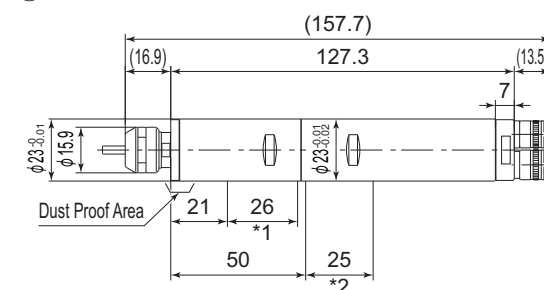

Fig. 1 R Type

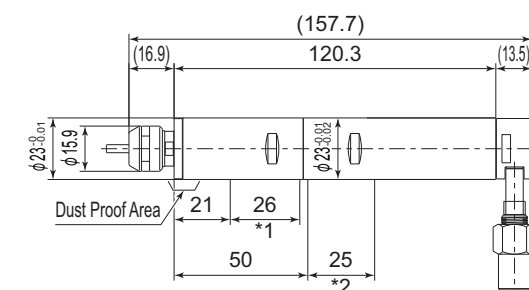

Fig. 2 RA Type

② MSST - 2308

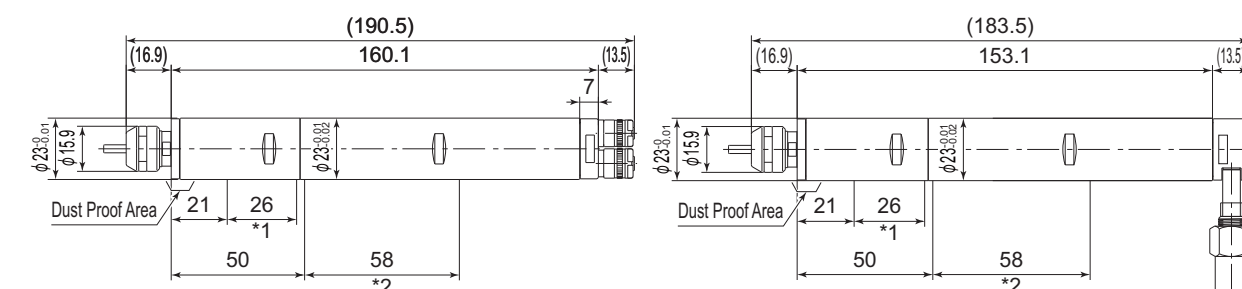

Fig. 3 R Type

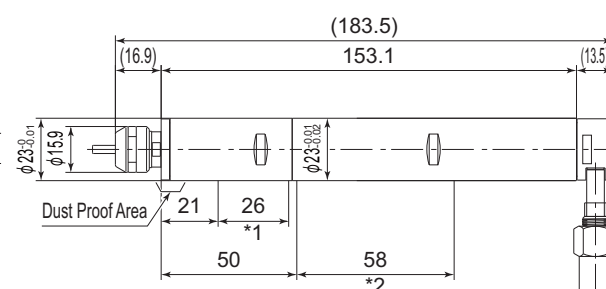

Fig. 4 RA Type

③ MSST - 2302

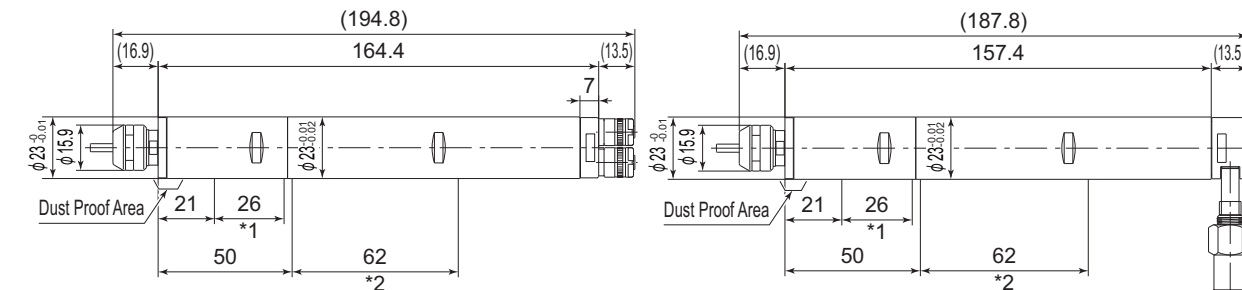

Fig.5 R Type

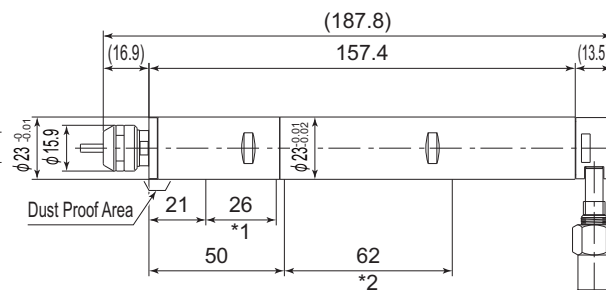

Fig. 6 RA Type

Table. 2

Clamping Area ①	Clamping Area ②
* 1	* 2

6 - 3 Torque Characteristics

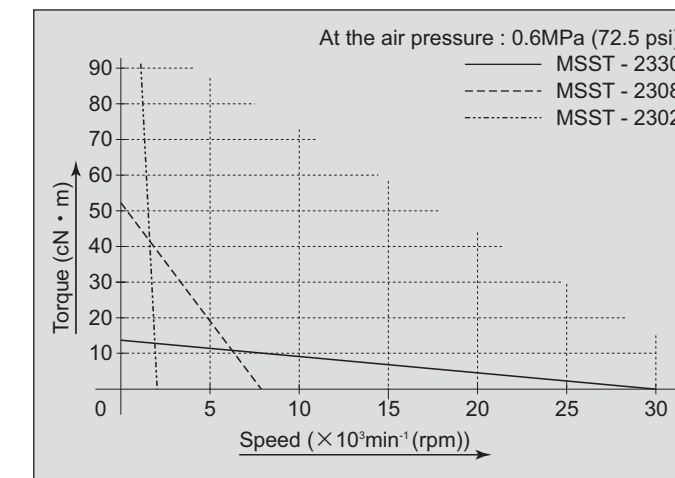

Fig. 7

7. CHANGING THE TOOL

CAUTION

Do not tighten the collet chuck without inserting a tool or dummy bur, as this will damage the collet chuck, spindle or chuck nut, causing difficulty removing the collet chuck.

RECOMMENDATION

Please set the cutting tools to minimize the overhang amount. 13mm is the maximum amount of overhang to maintain high accuracy and safety.

- Set the provided 12mm wrench on the spindle.
- Place the provided 14mm wrench on the chuck nut and turn it counter-clockwise to loosen the collet chuck and remove the tool. (The first turn will loosen the chuck nut, but the tool will not release and turning will become stiff. Keep turning through the stiffness and the collet chuck will open.)
- Clean the collet chuck and chuck nut, then insert the new tool and tighten the collet chuck by turning clockwise. Do not over-tighten.

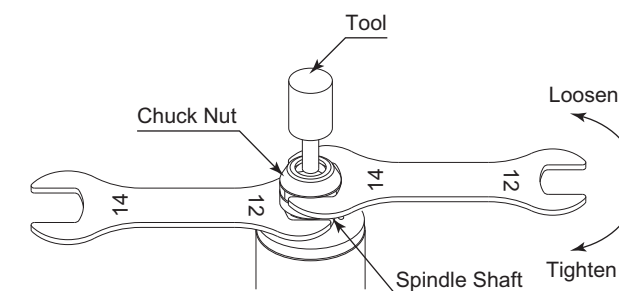

Fig. 8

8. REPLACING THE COLLET CHUCK

CAUTION

When installing the collet chuck into the chuck nut, be sure to fully engage the latch inside the chuck nut to the groove on the collet chucks outer diameter area. In addition, remember that if the collet chuck is attached without being engaged with the latch of the chuck nut, the collet chuck cannot be removed and this may cause damage to the collet chuck or the spindle.

- Remove the tool according to the section "7. CHANGING THE TOOL" procedure above and remove chuck nut assembly (Fig. 9).
- The collet chuck and chuck nut are secured by a groove in the collet chuck and a flange in the chuck nut. To remove the collet chuck hold the chuck nut in one hand and push diagonally down on the collet chuck. The collet chuck should be released (Fig. 10).
- To install the collet chuck, hold the collet chuck at a slight angle, and insert it into the chuck nut (Fig. 11). Press the collet chuck in the chuck nut by positioning the collet chuck in the chuck nut and pressing down on flat surface (Fig. 10). Be sure to fully engage the latch inside the chuck nut into the groove on the collet chucks outer circumference area (Fig. 12).

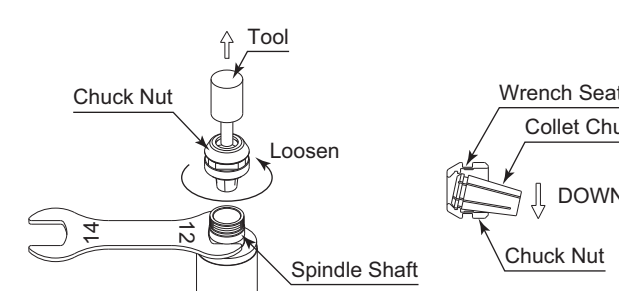

Fig. 9

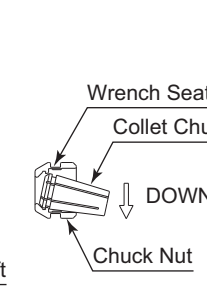

Fig. 10

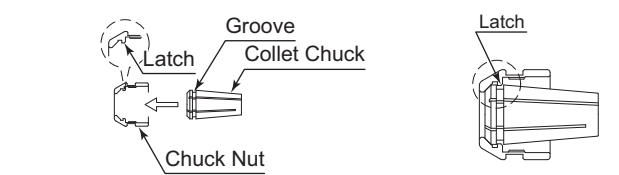

Fig. 11

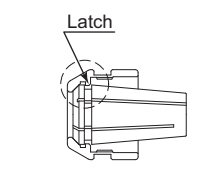

Fig. 12

9. INSTALLATION OF THE AIR MOTOR SPINDLE

CAUTION

- When installing an Air Motor Spindle, do not hit, drop or cause shock to the Air Motor Spindle. This may cause damage to internal components and result in malfunctions.
- When mounting the Air Motor Spindle, be sure to secure within Clamping area etched on the Air Motor Spindle O.D. If the Air Motor Spindle is installed incorrectly, damage to the internal components is possible.
- Cautions when tightening the securing bolts on to a Split Type Holder
Do not over-tighten the bolt. This will cause damage to Air Motor Spindle's precision. Tighten the bolt until the Air Motor Spindle body can not be rotated by hand within the fixture. Extreme tightening is not necessary or recommended.
Apply working force and check that the Air Motor Spindle is tight before using.

- When mounting an Air Motor Spindle, refer to the Clamping Area etched on the Air Motor Spindle. These Air Motor Spindle have 2 Clamping Area refer to "6 - 2 Outside View (Fig. 1- Fig. 6)".
- When installing an Air Motor Spindle to the holder, recommended installation method is shown Fig 13. Refer to "③ How to fabricate the Split Type Holder". If this is not possible, install as shown in Fig. 14.

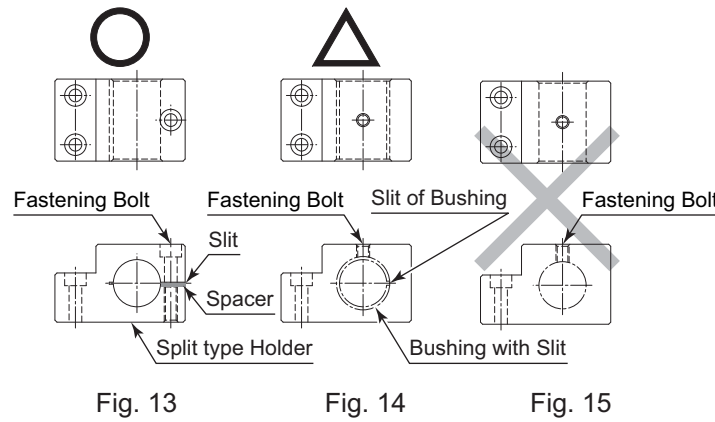

CAUTION

Do not allow set screws to come directly in contact with the Air Motor Spindle body as shown in Fig. 15, as this will result in damage to the Air Motor Spindle housing and internal components.
When installing, never clamp directly over the bearings, as this will result in bearing damage. (Refer to Fig. 16)

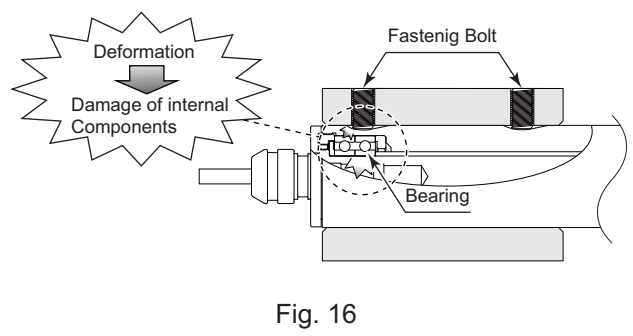

- How to fabricate the Split Type Holder
 - Rough bore the inside diameter of the Split Type Holder.
 - Cut a slit. (Ex. Slit 2mm) wide.
 - Tighten the Screw for Removal and Force Open the Slit Area.
 - Insert a spacer (Ex. thickness = 2mm) into the Slit Area.
 - Loosen the Screw for Removal, and tighten the fastening bolt with its specified torque.
 - Finish the Split Type Holder so that the inside diameter of the Split Type Holder is Air Motor Spindle's outside diameter (Refer to Table 3). The correct tolerance range for the holder is - 0.01mm to - 0.015mm and a roundness and cylindricity of less than 5µm.

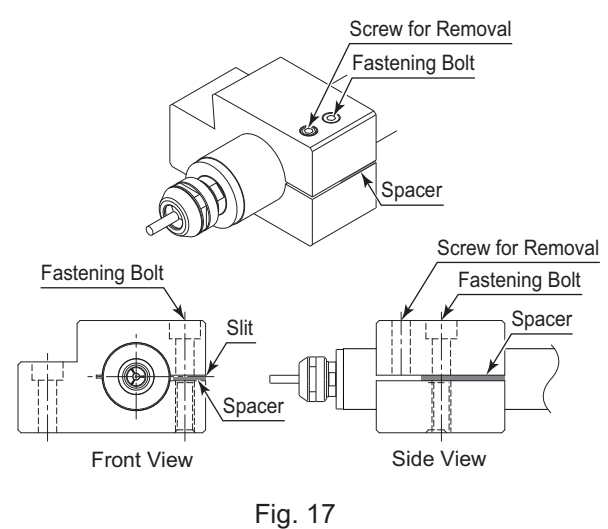

Table. 3

Clamping Area	Outside Diameter of Air Motor Spindle	Tolerance of Inside Diameter
Clamping Area ①	0	- 0.01
	-0.01	- 0.015
Clamping Area ②	-0.01	- 0.02
	-0.02	- 0.025

- When inserting the Air Motor Spindle loosen the Fastening Bolt, and tighten the Screw for Removal, widening the Slit Area.

CAUTION

The final responsibility for ensuring holder's safety for use in a given application is left to the designer of the equipment in which NAKANISHI's Air Motor Spindle is installed. NAKANISHI offers Air Motor Spindle with a wide variety of capabilities and specifications. Please carefully check the Air Motor Spindle's specifications against the requirements of your equipment and verify suitability and safety of the Holder prior to initial use.

10. INSTALLATION OF 90° ANGLE TYPE (RA) AIR MOTOR SPINDLE

CAUTION

The standard length of supply air / oil hose is 2m, and exhaust air / oil hose is 1m. When the supply and exhaust air / oil hose is longer than the standard length, the rotating speed is decreased.

- Remove Air Supply and Exhaust Pipes from the Air Motor Spindle.
- After pipes are removed, insert straight Air Motor Spindle from the front side of holder and fix it properly.
- Mount Air Supply and Exhaust Pipes on the Air Motor Spindle fixed on the holder and connect air / oil hose to the quick disconnect Joint of Air Supply and Exhaust Pipes. Air Supply air / oil hose (φ6 x φ4) and Air Exhaust air / oil hose (φ8 x φ6).

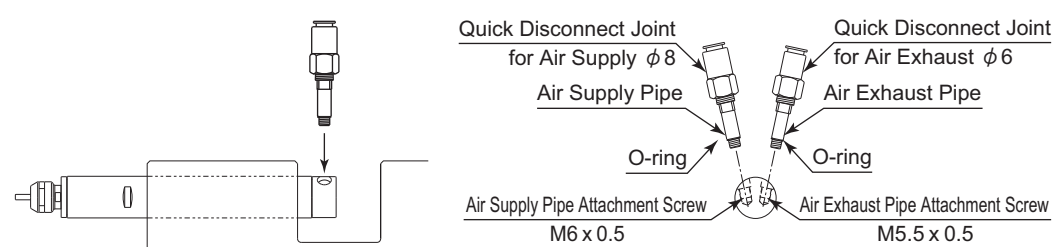

Fig. 18

11. CONNECTION TO THE AIR LINE KIT

CAUTION

Make sure to turn the compressed air supply to the Air Line Kit OFF, before replacing the Lubricating Oil or draining the water in Lubricating Oil.

- Connect the Filter Joint of the supply air / oil hose to the Secondary Joint (φ6 One - Touch Joint) of the Air Line Kit (Fig. 19 ①).
- Fill Oil Reservoir through the Oil Filler Cap with recommended NAKANISHI Lubricating Oil (K - 211 : Air Line Kit's Standard Accessories) to Upper Limit. Disconnect from air supply prior to opening Oil Filler Cap. Do not over or under fill.
- Connect the connection hose (Air Line Kit's Standard Accessories) to the Primary Joint of the Air Line Kit and Compressor. (Fig. 19 ②).
- Supply air from the air compressor and turn the Regulator Knob to set air pressure between 0.3 - 0.5 MPa (43.5 - 72.5psi).
- Turn the ON / OFF Valve and rotate the Air Motor Spindle with recommended proper air pressure. Adjust the Oil Drip Rate to the recommended volume which is 1 to 3 drops / min. (Commercially Air Line Kit is same Oil Drip Rate). (If using the "AL - 0304" or "K - 239" Air Line Kit, adjust the proper Oil Drip Rate to 30 - 40 drops / min).
※ Refer to the Operation Manual of the Air Line Kit for detailed information.
- Be sure to adjusted to proper Oil Drip Rate before using the Air Motor Spindle.

Lubricating Oil

Use ISO VG15 Liquid Paraffin (Shell Ondina Oil #15) in the Air Line Kit lubricator bowl. (For U.S.A. specification, use Chevron Superla #9).

Model
• Lubricating Oil (K - 211) 70cc
• Lubricating Oil (K - 202) 1ℓ

CAUTION

- When connecting the Compressor and Air Line Kit, recommended install the air filter or air dryer to between Compressor and Air Line Kit in order to supply clean dry air to the Air Motor Spindle. Using compressed air containing excessive moisture could result in malfunction or failure of the Air Motor Spindle. If excessive moisture or condensation are found in Air Filter Bowl (Filter Regulator Bowl), it will be necessary to install a dryer and larger Air Filter on the Primary Joint side of the Air Line Kit to prevent and remove excessive moisture.
- Connect the input air supply connection hose and supply air / oil hose securely to avoid accidental disconnection during use. Input air pressure should never exceed 1.0MPa (145psi). Air pressure exceeding 1.0MPa (145psi) may cause the supply connection hose and or air / oil hose supply to rupture.
- Make sure operation air pressure is less than 1.0MPa (145psi) before connecting the input supply connection hose and air / oil supply hose. If operation air pressure is exceeds 1.0MPa (145psi), injury to the operator may occur by accidental disconnection before or during use.
- Before use, carefully read "Air Line Kit Operation Manuals" regarding the correct connection, operation and cautions when using the Air Line Kit.

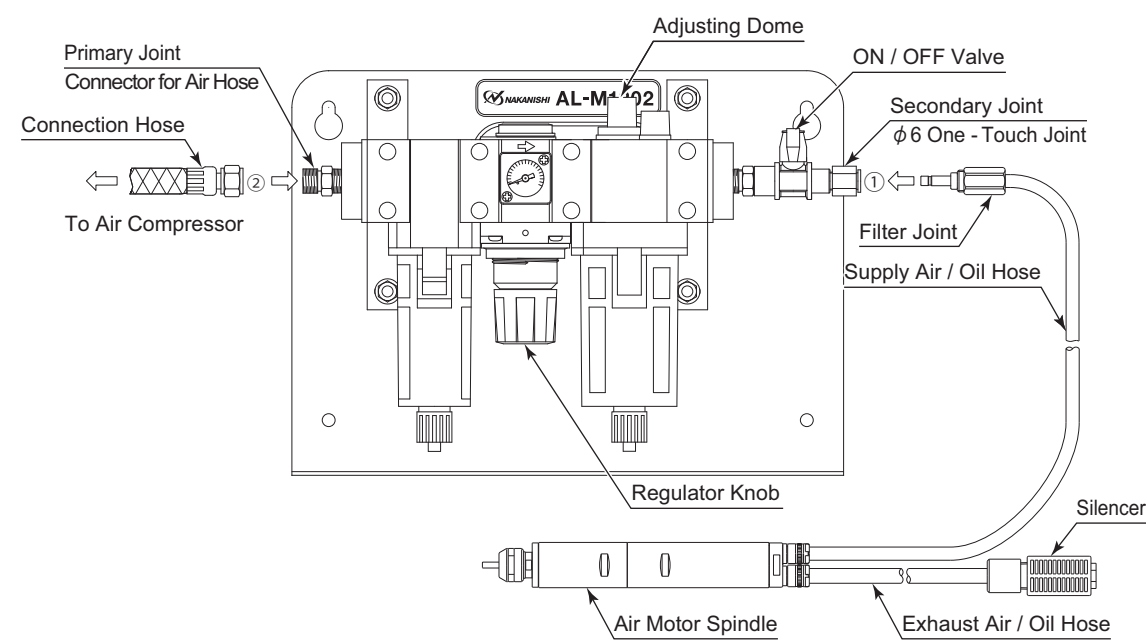

Fig. 19 Connection of Air Line Kit "AL - M1202 (Sold Separately)"

12. CAUTIONS WHEN USING GRINDSTONES AND TOOLS

CAUTION

The maximum surface speed or rpm is always specified for a grindstone. Do not exceed the maximum speed with reference to the calculating chart below. Always follow the grindstone manufacturer's recommendations.

$$\text{Surface Speed (m / s)} = \frac{3.14 \times \text{Diameter (mm)} \times \text{Rotation Speed (min}^{-1} \text{) (rpm)}{1,000 \times 60}$$

- The proper surface speed for general grindstones is 10 - 30m / s.
- Do not exceed 13mm of overhang for mounted grindstones as shown in Fig. 20. If the overhang must exceed 13mm, reduce the motor speed in accordance with Table 4.
- Dress the grindstone prior to use.
- Do not use cutting tools with bent or broken shanks, cracks or excessive run-out.
- For grinding, the maximum depth of cut should not exceed 0.01mm radially or axially. Reciprocate the tool several times after each pass to eliminate tool pressure.
- Always operate cutting tools within the allowable recommended speed of the cutting tools. Use of a cutting tool outside of the allowable speed of the cutting tools could cause damage to the spindle and injury to the operator.
- Keep the cutting tool shank and collet chuck clean. If contaminants are left in the collet chuck or chuck nut, excessive run-out will cause damage to the cutting tool and or spindle.
- Do not strike or disassemble the spindle.
- Please set the cutting tools to minimize the overhang amount. 13mm is the maximum amount of overhang to maintain high accuracy and safety.

Table. 4 Overhang and Speed

Overhang (mm)	Max. Speed (min ⁻¹) (rpm)
20	N x 0.5
25	N x 0.3
50	N x 0.1

*N=Max. Operating Speed with 13mm overhang.

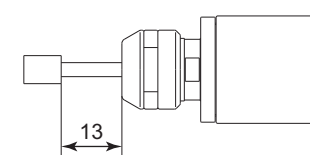

Fig. 20

13. TROUBLESHOOTING

If a problem or concern occur, please check the following items prior to consulting your dealer.

Trouble	Cause	inspection / Corrective Action
Air Motor Spindle does not rotate or rotate smoothly.	Air flow does not reach the Air Motor spindle.	Check if input supply connection hose or air / oil supply hose is broken, bent or disconnected. Check connection of the input supply connection and air / oil supply hoses. Check the compressor power supply and the air compressor output. Check the Regulator and set to the correct air pressure. Check all connections input supply and air / oil supply hose.
	The spindles ball bearings have been damaged.	Replace the ball bearings. (Return to NAKANISHI dealer service.)
	The motor has been damaged by for no Lubricating Oil.	Replace the motor. (Return to NAKANISHI dealer service.)
	Air Motor Spindle speed is too slow.	The connection hose or air / oil supply hose have been damaged. Poor connection of input supply or air / oil supply hose. Low air pressure. Low Lubricating Oil.
Unequal motor rotation.	No Lubricating Oil.	Clean inside of the motor use the Lubricating Oil. Removing the Filter Joint from Air Line Kit, supply a small amount of Lubricating Oil directly into the Filter Joint. Afterwards, supply air pressure and rotate the Air Motor Spindle. Flush dirt in the motor and repeatedly do this work about three times. When the improvement is not seen, return to NAKANISHI dealer service.
	Water, dirt and debris are collected in the Air Filter.	Drain water, dirt and debris from the Air Filter Bowl.
	Water in Lubricating Oil reservoir.	Drain water from Lubricating Oil reservoir and replace with clean Lubricating Oil.
	Lubricator inclined or upside down.	Inclined or upside down lubricator will flood spindle with lubricating Oil.
Overheating during rotation.	Excessive Oil Drip Rate flooding the bearings.	Oil drip rate exceeds the recommended amount. Adjust for the proper Oil Drip Rate.
	Over filled lubricator. (Air Line Kit "AL - 0304 or K - 239" only.)	Drain the Lubricating Oil from Reservoir to meet indicated levels. Excess lubricant will flood spindle.
Abnormal vibration or noise during rotation.	Cutting debris has contaminated the ball bearings, and the ball bearings are damaged.	Replace the ball bearings. (Return to NAKANISHI dealer service.)
	The tool shank is bent.	Replace the tool.
Tool slippage.	Cutting debris has contaminated the ball bearing.	Replace the ball bearings. (Return to NAKANISHI dealer service.)
	The spindles ball bearings have been damaged.	Replace the ball bearings. (Return to NAKANISHI dealer service.)
High run-out.	Collet chuck or chuck nut are not correctly installed.	Check and clean the collet chuck and chuck nut. Reinstall the collet chuck and chuck nut.
	The collet chuck and the chuck nut are worn.	Replace the collet chuck and chuck nut.
	The tool is bent.	Change the tool.
	Chuck nut is not correctly installed.	Secure the collet chuck and the chuck nut correctly.
	The collet chuck and the chuck nut are worn.	Replace the collet chuck and the chuck nut.
	Inside of the spindle is worn.	Replace the spindle shaft. (Return to NAKANISHI dealer service.)
	Contaminants inside the collet chuck and the chuck nut or the spindle.	Clean the collet chuck, chuck nut and the inside of the taper and spindle.
	The spindle ball bearings has been damaged.	Replace the ball bearings. (Return to NAKANISHI dealer service.)

14. DISPOSAL OF THE AIR MOTOR SPINDLE

When disposal of an Air Motor Spindle is necessary, follow the instructions from your local government agency for proper disposal of industrial components.