

HIGH TORQUE BRUSHLESS MICRO-GRINDER

# Espert 500 Series

## ESPERT 500 SERIES ◀◀



Espert 500 Standard Set

Code No.	<b>9881</b> (120V)	Model	<b>ES50C-HR</b>
	<b>9882</b> (230V)		

### The Ultimate in Everything

- Speed : 1,000~50,000 min<sup>-1</sup>
- NAKANISHI Smart Switch
- Max. Output : 200W



### Low Noise, Low Vibration

The brushless motor and incorporated cooling fan have reduced the vibration and noise levels dramatically compared with conventional models, resulting in a quieter, more comfortable work environment.

### Wide Range of Collets Available

Collet sizes range from a tiny 0.3 mm up, with a wide variety of sizes available. (p.4-3~4)  
Tools can be changed without the use of any wrenches.



Espert 500 Compact Motor Handpiece

Code No.	<b>9091</b>	Model	<b>ENK50C-HR</b>
----------	-------------	-------	------------------

Standard Size Collet : ø3.0 mm (CHH-3.0), ø2.35 mm (CHH-2.35)

### Features of Motor Handpiece

#### Speed : 1,000~50,000 min<sup>-1</sup>

Speed is steplessly variable from 1,000~50,000 min<sup>-1</sup>. Smooth and powerful torque is delivered at both high and low speeds. The maximum speed of 50,000 min<sup>-1</sup> allows high precision micro-processing.

#### 2 Types of Motors

Very high torque from compact motors.

	NAKANISHI Smart Switch Color	
• Compact Type (ENK-500C)	140W	Blue
• Torque Type (ENK-500T)	200W	Gray

#### NAKANISHI Smart Switch

The switch has a moderate clicking sensation, and the controller emits a beeping sound in response to operation. The switch color indicates the motor type.



#### Excellent Durability

High performance brushless motor eliminates the need to change carbon brushes. NAKANISHI's internal load test has demonstrated continuous use for more than 5,000 hours.

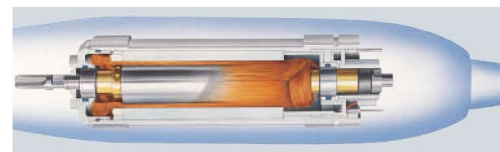

#### High Precision

NAKANISHI's ultra-precision technology ensures a center runout below 0.02 mm, which allows for very high precision finishing.

#### Simple Screw on Attachments



### Special Dust-Proof Mechanism

This handpiece has a patented built-in-dust protection system to prevent the infiltration of dust and debris into the front bearings. This NAKANISHI patented design assures long-term durability.

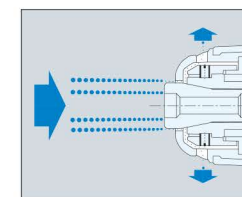

### Micro Grinder & Handpiece Stand

This specially designed micromotor stand allows easy pick-up and set-down of the micro-grinder. Strong, but soft to the touch, the micro-grinder stand contains convenient, integrated storage compartments for adjustment wrenches and a spare collet.



### 9 Types of Attachments Available

9 different types of attachments making an almost infinite number of applications possible.



CAUTION

Electric System

Air System

Ultrasonic

General Parts

Exclusive Tools

CAUTION

Electric System

Air System

Ultrasonic

General Parts

Exclusive Tools

ADVANCED HIGH PERFORMANCE CONTROLLER

# Espert 500 Series

ESPERT 500 SERIES ◀◀



Espert 500 Torque Set

Code No.	9883 (120V)	Model	ES50T-HR
	9884 (230V)		

The Ultimate in Everything



### Portable Controller with Carrying Handle

Very convenient to be carried.



## Features of Controller

### Optimal Control via Microcomputer

The operation of all Espert 500 functions is controlled by a high performance microcomputer (CPU) that is programmed with NAKANISHI's proprietary technology. NAKANISHI's CPU has direct control of the brushless micro-grinder allowing smooth and highly precise cutting and polishing of a wide variety of materials. Bur "chatter" has been eliminated. The system automatically senses which micromotor is attached (ENK-500C or ENK-500T) and self adjusts to provide optimum micro-grinder performance.

### Auto Cruise Function

The controller is equipped with an auto cruise function that operates the micro-grinder at a preset speed without the need to use the foot pedal. This function eliminates foot fatigue during prolonged operation.

### Simplified Hand and Foot Pedal Control

You no longer need to push a switch on the controller to switch between hand and foot pedal control. If you want to operate the motor handpiece by hand simply push the NAKANISHI Smart Switch, if you want to use foot pedal control simply depress the foot pedal.

### Memory Speed Function FiXpeed®

An exclusive new feature of the Espert 500 system, the FiXpeed® system allows the user to independently preset the speed of motor A and motor B. For example motor A can be set to maintain the speed set by the FiXpeed® system while motor B has variable control using a foot pedal. This function allows for unprecedented flexibility.

### Eco-Friendly Design

The electronic circuits are designed using NAKANISHI's proprietary technology to meet eco-friendly expectations by minimizing power consumption. Since power demands are minimal, no significant heat is generated and no cooling fan is required.

### Error Code Display Function

Detects trouble and failures occurring within the motor or unit and displays them as one of seven types of error codes (E0-E6). This reassuring function permits the user to correct the problem. Possible errors are overload, open circuit, motor lock, controller overheat, etc.



### Other Features

- Self Check Function (Maintenance Mode)
- Smooth Operation • Operation Check Sound
- Highly Visible and easy to operate front panel
- 2-Digit Digital Display
- A / B 2 Motors Can Be Connected (Simultaneous motor operation is not allowable)

Code No.	9793 (120V)
	9794 (230V)
Model	NE96

\* Please check the power source plug type (p.4-6).

### Specifications

Description	Espert 500 Controller
Power Source	AC 120/230V, 50-60 Hz
Dimensions	W172 x D230 x H94 mm
Weight	2.6 kg

Accessories : Handpiece Holder : 1 pc.  
Handpiece Stand : 1 pc.

CAUTION

Electric System

Air System

Ultrasonic

General Parts

Exclusive Tools

CAUTION

Electric System

Air System

Ultrasonic

General Parts

Exclusive Tools

PRECISION BRUSHLESS MICRO-GRINDER

# Esperit 500 Sets

With Motor ON/OFF Switch

- Speed Range : 1,000~50,000 min<sup>-1</sup>
- Microprocessor controlled for optimal motor control
- Hand Switch [NAKANISHI Smart Switch]
- Memory Speed Function [Fixspeed®]

**High Power &  
High Torque !!**



## Esperit 500 Standard Set



**1,000~50,000 min<sup>-1</sup>** **140w**

- High Power System.  
<Max. Output 140W>

Code No.	<b>9881</b> (120V)
	<b>9882</b> (230V)
Model	<b>ES50C-HR</b>

※Please check the power source plug type (p.4-6).

- Standard Equipment
- Controller (NE96) : 1 pc.
  - Compact Motor Handpiece (ENK50C-HR) : 1 pc.

- Standard Accessories
- Collet ø3.0 mm (CHH-3.0), ø2.35 mm (CHH-2.35)
  - Handpiece Holder : 1 pc. • Handpiece Stand : 1 pc.
  - Wrench (7 x 5.1) : 1 pc. • Pin Wrench (K-233) : 1 pc.
  - L Shaped Wrench (9) : 1 pc.

## Esperit 500 Torque Set



**1,000~50,000 min<sup>-1</sup>** **200w**

- Highest Power in its Class.  
<Max. Output 200W>

Code No.	<b>9883</b> (120V)
	<b>9884</b> (230V)
Model	<b>ES50T-HR</b>

※Please check the power source plug type (p.4-6).

- Standard Equipment
- Controller (NE96) : 1 pc.
  - Torque Motor Handpiece (ENK50T-HR) : 1 pc.

- Standard Accessories
- Collet ø3.0 mm (CHH-3.0), ø2.35 mm (CHH-2.35)
  - Handpiece Holder : 1 pc. • Handpiece Stand : 1 pc.
  - Wrench (7 x 5.1) : 1 pc. • Pin Wrench (K-233) : 1 pc.
  - L Shaped Wrench (9) : 1 pc.

PRECISION BRUSHLESS MICRO-GRINDER

# Esperit 500 Motor Handpiece

With Motor ON/OFF Switch

1,000~50,000 min<sup>-1</sup>

- Speed Range : 1,000~50,000 min<sup>-1</sup>
- Microprocessor controlled for optimal motor control
- Hand Switch [NAKANISHI Smart Switch]
- Memory Speed Function [Fixspeed®]

MOTOR-HANDPIECE



## Esperit 500 Compact Motor Handpiece

**1,000~50,000 min<sup>-1</sup>** **140w**

Code No.	<b>9091</b>
Model	<b>ENK50C-HR</b>

Standard Size Collet

ø3.0 mm (CHH-3.0) ø2.35 mm (CHH-2.35)  
Optional Collets : CHH Group are shown in page (p.4-3)

- Standard Accessories
- Wrench (7 x 5.1) : 1 pc.
  - Pin Wrench (K-233) : 1 pc.
  - L Shaped Wrench (9) : 1 pc.



## Esperit 500 Torque Motor Handpiece

**1,000~50,000 min<sup>-1</sup>** **200w**

Code No.	<b>9092</b>
Model	<b>ENK50T-HR</b>

Standard Size Collet

ø3.0 mm (CHH-3.0) ø2.35 mm (CHH-2.35)  
Optional Collets : CHH Group are shown in page (p.4-3)

- Standard Accessories
- Wrench (7 x 5.1) : 1 pc.
  - Pin Wrench (K-233) : 1 pc.
  - L Shaped Wrench (9) : 1 pc.



Code No.	d	D	l1	l2	L	Weight	Max. Output	Speed Range	Collet
<b>9091</b>	ø13.3	ø26.8	59.4	107.8	167.2	210 g(*)	140W	1,000~50,000 min <sup>-1</sup>	ø0.3~ø3.175 mm
<b>9092</b>	ø13.3	ø28.3	59.4	121.4	180.8	250 g(*)	200W	1,000~50,000 min <sup>-1</sup>	CHH Group (p.4-3)

※ Weight (w/o Coiled Cord)

CAUTION

Electric System

Air System

Ultrasonic

General Parts

Exclusive Tools

CAUTION

Electric System

Air System

Ultrasonic

General Parts

Exclusive Tools

Espert 500 Series System Chart

Code No.	Model
<b>Attachment</b>	
Ring Type	
9090	EHR-500
Lever Type	
1515	EHL-401
6 mm Torque Type	
1552	EHG-400
90° Angle Type	
1525	EIC-300
50° Angle Type	
1526	EKC-300
90° Angle Torque Type	
1551	ERA-270
LUSTER (Reciprocating motion)	
1516	ELS-100
MINI-LUSTER (Reciprocating motion)	
1554	EML-8
FINE BELT SANDER	
1145	EBS-101
<b>Speed Reducer</b>	
1/4 Speed Reducer	
1553	ERG-01B
* May be connected between the motor and the attachment when required increased torque.	
<b>Motor</b>	
Compact Motor with Cord	
9088	ENK-500C
1,000~50,000 min <sup>-1</sup>	
Torque Motor with Cord	
9089	ENK-500T
1,000~50,000 min <sup>-1</sup>	
<b>Controller</b>	
Espert 500 Controller	
9793 (120V)	NE96
9794 (230V)	
<b>Sets</b>	
Espert 500 Standard Set	
Code No.	Model
9881 (120V)	ES50C-HR
9882 (230V)	
Standard Equipment	
• Compact Motor Handpiece (ENK50C-HR) : 1 pc.	
• Collet ø3.0 mm (CHH-3.0), ø2.35 mm (CHH-2.35)	
• Controller (NE96) : 1 pc.	
Standard Accessories	
• Handpiece Holder : 1 pc. • Handpiece Stand : 1 pc.	
• Wrench (7 x 5.1) : 1 pc. • Pin Wrench (K-233) : 1 pc.	
• L Shaped Wrench (9) : 1 pc.	
Emax EVOLUTION, ELECTER E-max and ROTUS attachments can be connected using these adaptors.	
Extension Adaptor	
1518	ECN-011
1/4 Speed Reducer	
1517	ERG-01

⚠ Details of Maximum Allowable speed on intermittent use or continuous use p.1-29-31

Espert 500 Series

Espert 500 Controller

Code No.	9793 (120V)
	9794 (230V)
Model	NE96

- Microprocessor controlled for optimal motor control.
- Memory Speed Function FiXspeed®.
- ◆ Power Source : AC120/230V, 50-60 Hz
- ◆ Dimensions : W172 x D230 x H94 mm
- ◆ Weight : 2.6 kg

Standard Accessories  
 • Handpiece Holder : 1 pc. • Handpiece Stand : 1 pc.

※ Please check the power supply cord plug type (p.4-6).



Espert 500 Compact Type Motor

Code No.	9088
Model	ENK-500C

**1,000~50,000 min<sup>-1</sup>**

- Incorporates the NAKANISHI Smart Switch for easy ON / OFF operation.
- Small, lightweight, high-speed brushless DC motor.

- ◆ Output Power : 140 W
- ◆ Max. Torque : 6.0 cN·m
- ◆ Cord Length : 1.5 m
- ◆ Weight : 115 g (w/o cord)



Espert 500 Torque Type Motor

Code No.	9089
Model	ENK-500T

**1,000~50,000 min<sup>-1</sup>**

- Incorporates the NAKANISHI Smart Switch for easy ON / OFF operation.
- High-power, high-torque, high-speed brushless DC motor.

- ◆ Output Power : 200 W
- ◆ Max. Torque : 8.7 cN·m
- ◆ Cord Length : 1.5 m
- ◆ Weight : 160 g (w/o cord)



### Ring Type Attachment

Code No. **9090** Model **EHR-500**



- 50,000 min<sup>-1</sup> Max.**
- High precision and high reliability is realized by micron grade precision.
  - Slim, lightweight design allows for fine finishing of delicate parts.
  - One-touch ring type bur replacement.



◆ Weight : 94 g  
 Standard Size Collet  
**ø3.0 mm (CHH-3.0) ø2.35 mm (CHH-2.35)**  
 Optional Collets : CHH Group are shown in page (p.4-3)  
 Standard Accessories  
 • Wrench (7 x 5.1) : 1 pc. • Pin Wrench (K-233) : 1 pc.  
 • L Shaped Wrench (9) : 1 pc.

### Lever Type Attachment

Code No. **1515** Model **EHL-401**



- 50,000 min<sup>-1</sup> Max.**
- High precision and high reliability is realized by micron grade precision.
  - Slim, lightweight design allows for fine finishing of delicate parts.
  - Lever Type one touch bur release.



◆ Weight : 70 g  
 Standard Size Collet  
**ø3.0 mm (CHH-3.0) ø2.35 mm (CHH-2.35)**  
 Optional Collets : CHH Group are shown in page (p.4-3)  
 Standard Accessories  
 • Wrench (7 x 5.1) : 1 pc. • Pin Wrench (K-233) : 1 pc.

### 6 mm Torque Type Attachment

Code No. **1552** Model **EHG-400**



- 40,000 min<sup>-1</sup> Max.**
- ø6.0 mm shank burs ready.
  - Collet is tightened by a wrench.



◆ Weight : 110 g  
 Standard Size Collet  
**ø6.0 mm (CHG-6.0)**  
 Optional Collets : CHG Group are shown in page (p.4-3)  
 Standard Accessories  
 • Wrench (10 x 10) : 1 pc.  
 • Bar Wrench (K-212) : 1 pc.

### 90° Angle Torque Attachment

Code No. **1551** Model **ERA-270**



- 27,000 min<sup>-1</sup> Max.**
- Large gear for better durability and high load capacity.
  - Perfect for finishing bottom surfaces and other tight, hard to reach areas.
  - Suitable for polishing a flat surface at speed with a grinding disk pad.



◆ Speed Reduction Ratio : 1/1.5  
 ◆ Weight : 107 g  
 Standard Size Collet **ø3.0 mm (CHS-3.0)**  
 Optional Collets : CHS Group are shown in page (p.4-4)  
 Standard Accessories  
 • Wrench (8 x 5) , (7 x 5.1) , (20 x 24) : 1 pc. each

### 90° Angle Attachment

Code No. **1525** Model **EIC-300**

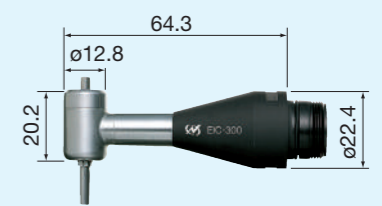

- 30,000 min<sup>-1</sup> Max.**
- Suitable for polishing a flat surface at speed with a grinding disk pad.
  - Capable of applications for rough cutting to mirror finishing.
  - Speed Reduction Ratio : 3/4



◆ Weight : 54 g  
 Standard Size Collet **ø3.0 mm (CHC-3.0)**  
 Optional Collets : CHC Group are shown in page (p.4-3)  
 Standard Accessories  
 • Wrench (20 x 24) : 1 pc.  
 • Collet Wrench (K-231) : 1 pc.  
 • Standard Accessories : 1 set

Code No.	Description	Package
64101	Rubber Pad (Small) O.D. ø10 mm	1 pc./pack
64102	Rubber Pad (Med) O.D. ø20 mm	
64103	Rubber Pad (Large) O.D. ø30 mm	
64203	Sand Paper Disk for small pad ø11 #180	5 pcs./pack
64207	Sand Paper Disk for small pad ø11 #600	
64213	Sand Paper Disk for med. pad ø21 #180	
64217	Sand Paper Disk for med. pad ø21 #600	
64223	Sand Paper Disk for large pad ø31 #180	
64227	Sand Paper Disk for large pad ø31 #600	

CAUTION

CAUTION

Electric System

Electric System

Air System

Air System

Ultrasonic

Ultrasonic

General Parts

General Parts

Exclusive Tools

Exclusive Tools

### 50° Angle Attachment

Code No. **1526** Model **EKC-300**

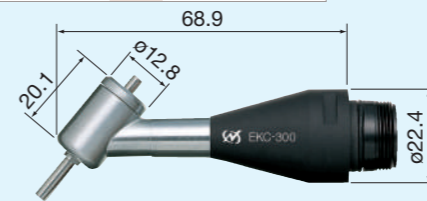

- 30,000 min<sup>-1</sup> Max.**
- Perfect for finishing bottom surfaces and other tight, hard to reach areas.
  - Suitable for polishing a flat surface at speed with a grinding disk pad.
  - Speed Reduction Ratio : 3/4. Use the motor in reverse rotation for clockwise rotation.



◆ Weight : 54 g  
 Standard Size Collet **ø3.0 mm (CHC-3.0)**  
 Optional Collets : CHC Group are shown in page (p.4-3)  
 Standard Accessories  
 • Wrench (20 x 24) : 1 pc.  
 • Collet Wrench (K-231) : 1 pc.  
 • Standard Accessories : 1 set

Code No.	Description	Package
64101	Rubber Pad (Small) O.D. ø10 mm	1 pc./pack
64102	Rubber Pad (Med) O.D. ø20 mm	
64103	Rubber Pad (Large) O.D. ø30 mm	
64203	Sand Paper Disk for small pad ø11 #180	5 pcs./pack
64207	Sand Paper Disk for small pad ø11 #600	
64213	Sand Paper Disk for med. pad ø21 #180	
64217	Sand Paper Disk for med. pad ø21 #600	
64223	Sand Paper Disk for large pad ø31 #180	
64227	Sand Paper Disk for large pad ø31 #600	

### LUSTER Attachment (Pistol-Type Polisher)

Code No. **1516** Model **ELS-100**

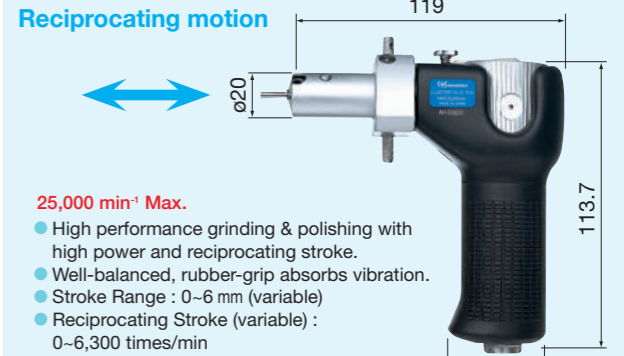

- 25,000 min<sup>-1</sup> Max.**
- High performance grinding & polishing with high power and reciprocating stroke.
  - Well-balanced, rubber-grip absorbs vibration.
  - Stroke Range : 0-6 mm (variable)
  - Reciprocating Stroke (variable) : 0-6,300 times/min



◆ Weight : 680 g  
 ◆ Max. tool shank diameter ø6.4 mm, Screw clamp type  
 Standard Accessories  
 • Allen Wrench (2 mm), (3 mm) : 1 pc. each  
 • Lubricating Oil • Lubrication Nozzle for LUSTER  
 • Standard Accessories : 1 set

Code No.	Description	Package
62502	Stone Holder	1 pc./pack
62505	Stone Holder	
62751	Spring Holder	
62525	Rectangular Pad	10 pcs./pack
62526	Rod for Rectangular Pad	
62527	Angle Rod	
62552	Sand Paper Tip #120	
62555	Sand Paper Tip #320	
62557	Sand Paper Tip #600	
62559	Sand Paper Tip #1000	

### MINI-LUSTER Attachment (Pencil-Type Reciprocating Polishing Finisher)

Code No. **1554** Model **EML-8** Stroke (0.8 mm)

#### Reciprocating motion

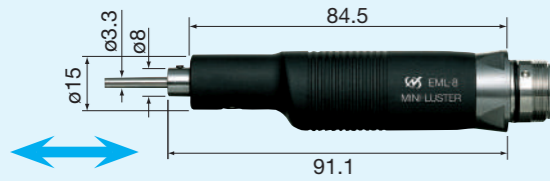

- 25,000 min<sup>-1</sup> Max.**
- High Speed reciprocating polisher for rapid finishing of small surfaces.
  - The lightweight pencil type design makes it very controllable.
  - Ideal for small, tight areas such as tight corners, ribs, etc.
  - Reciprocating Speed (variable) : 0~10,000 strokes/min
  - Weight : 130 g
  - Max. tool shank diameter  $\phi 3.5$  mm, Screw clamp type

Standard Accessories  
 • Allen Wrench (1.5mm) : 1 pc. • Standard Accessories : 1 set

Code No.	Description	Package
62751	Spring Holder	1 pc./pack
62510	Ceramic Fiber Grindstone Holder	
62814	Electroplated Diamond File 1.25 x 4 x 50 #100	
60520	Ceramic Fiber Grindstone 1 x 6 x 50 #1200	

Exclusive Tools p.5-19~22

### FINE BELT SANDER Attachment

Code No. **1145** Model **EBS-101**

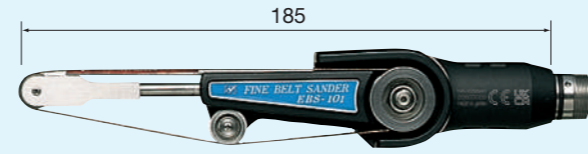

**30,000 min<sup>-1</sup> Max.**

- Very high belt speed, ideal for applications from deburring to radius finishing.
- Belt Speed : 0~705 m/min
- Weight : 355 g
- Belt Sizes : 4, 6, 8 mm wide x 300 mm long

Standard Accessories  
 • Allen Wrench (3 mm) : 1 pc.  
 • Standard Accessories : 1 set

Code No.	Description	Package
64902	Abrasive Belt Width 4 mm #120	2 pcs. each
64904	Abrasive Belt Width 4 mm #240	
64906	Abrasive Belt Width 4 mm #400	
64912	Abrasive Belt Width 6 mm #120	
64914	Abrasive Belt Width 6 mm #240	
64916	Abrasive Belt Width 6 mm #400	
64922	Abrasive Belt Width 8 mm #120	
64924	Abrasive Belt Width 8 mm #240	
64926	Abrasive Belt Width 8 mm #400	

Exclusive Tools p.5-32

### 1/4 Speed Reducer

Code No. **1553** Model **ERG-01B**

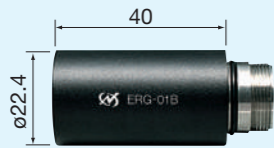

- 30,000 min<sup>-1</sup> Max.**
- Mounted between an attachment and a motor.
  - The speed is reduced to 1/4 while the torque is multiplied by 4 times.
  - Suitable for high torque grinding process or drilling.
  - Weight : 65 g

Standard Accessories  
 • Pin Wrench (K-233) : 1 pc.

### Extension Adaptor

Code No. **1518** Model **ECN-011**



- 40,000 min<sup>-1</sup> Max.**
- The Adaptor can be used with the attachments for Emax EVOLUTION, E-max and ROTUS you already have.
  - Weight : 31 g

Standard Accessories  
 • Wrench (20 x 24) : 1 pc.

### 1/4 Speed Reducer

Code No. **1517** Model **ERG-01**



- 30,000 min<sup>-1</sup> Max.**
- The Speed Reducer can be used with the attachments for Emax EVOLUTION, E-max and ROTUS you already have.
  - The speed is reduced to 1/4 while the torque is multiplied by 4 times.
  - Suitable for high torque grinding process or drilling.
  - Weight : 62 g

Standard Accessories  
 • Pin Wrench (K-233) : 1 pc.

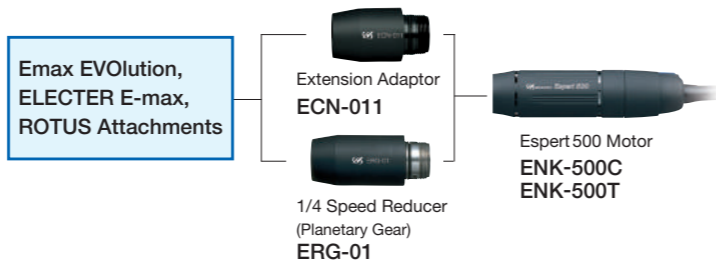

### Esper 500 Series Spare Parts

Product	Description	Code No.	Model	Specifications
	Foot Pedal	<b>1440</b>	FC-40	• Variable Speed Control
	Esper 500 Handpiece Stand	<b>8104</b>	K-274	—
	Esper 500 Compact Motor Cord	<b>9093</b>	ENKCD-50C	• Compact Motor Cord • 1.5 m Long
	Esper 500 Torque Motor Cord	<b>9094</b>	ENKCD-50T	• Torque Motor Cord • 1.5 m Long

CAUTION

Electric System

Air System

Ultrasonic

General Parts

Exclusive Tools

CAUTION

Electric System

Air System

Ultrasonic

General Parts

Exclusive Tools

## For safe usage

- Please read operation manuals before using any NAKANISHI product.
- Please keep the operation manuals on hand so that the user can refer to them at any time.

## ⚠ Caution

Incorrect use of the product, or ignoring 'CAUTIONS for safety' described in the operating manuals may cause fatal or serious bodily injury.

## CAUTIONS

	<b>Always use safety glasses, masks, face guards for your safety.</b>		<b>Select proper hand tools and for your application.</b> Select tools carefully considering the performance of the hand tools, work procedure and type / shape of the material.
	<b>Do not touch the tools and hand tools when in operation.</b> Make sure the work area is neat and there is sufficient light.		<b>Do not wear loose clothing and/or accessories that may be caught in machinery.</b> Long hair should be tied prior to machine operation.
	<b>Do not operate the products where flammable liquids or gases exist.</b>		<b>Fix the work material firmly in a vise and/or other clamping fixture.</b>
	<b>Do not leave the work area with the hand tools still in operation.</b> Confirm that the hand tools have completely stopped after switching them off.		<b>Perform an inspection before use.</b> Clean the inside of the collet and tool shank, chips or fine metals inside the collet could cause tool slippage and result in damage to machinery or bodily injury.

	<b>Fasten the chuck firmly.</b> Make sure the tool is intact in the chuck to avoid tool slippage.		<b>Do not apply high pressure or pry to the tools.</b> This can break and/or bend the tools. Use the tools within their design limitation. Excessive pressure will decrease the efficiency of your work and cause excessive wear of the tools.										
	<b>Do not use damaged or broken electric cords and air hoses.</b>		<b>Check the tools carefully before use.</b> Confirm that the tools are free of chips, cracks, splits, scratches, lack of bonding, deformation, etc.										
	<b>Start at low speed and gradually increase to insure safe work.</b> This is particularly important for the use of new tools, large cutting tools and elastic tools such as rubber grindstone, sander and brush tools.		<b>Stop grinding or polishing immediately whenever unusual sounds, vibrations, or wear are found.</b> Restart the work only after the problem is solved.										
	<b>Store the tools and hand tools in a cool and dry place.</b>		<b>Only use attachments, parts, consumable articles and accessories produced by NAKANISHI INC.</b>										
	<b>The tools should be used by taking care of the overhang and below maximum allowable speed.</b> The catalogue shows the maximum allowable speed at 10 mm overhang (distance between the face of the collet and the top of the tool shank).	<p>Decrease the speed as shown in the table below, if you are using a longer overhang than 10 mm.</p> <table border="1"> <thead> <tr> <th>Overhang</th> <th>Maximum allowable speed (min<sup>-1</sup>)</th> </tr> </thead> <tbody> <tr> <td>Less than 10 mm</td> <td>Shown in the catalogue (A)</td> </tr> <tr> <td>Less than 20 mm</td> <td>(A) x 0.5</td> </tr> <tr> <td>Less than 25 mm</td> <td>(A) x 0.3</td> </tr> <tr> <td>Less than 50 mm</td> <td>(A) x 0.1</td> </tr> </tbody> </table>		Overhang	Maximum allowable speed (min <sup>-1</sup> )	Less than 10 mm	Shown in the catalogue (A)	Less than 20 mm	(A) x 0.5	Less than 25 mm	(A) x 0.3	Less than 50 mm	(A) x 0.1
Overhang	Maximum allowable speed (min <sup>-1</sup> )												
Less than 10 mm	Shown in the catalogue (A)												
Less than 20 mm	(A) x 0.5												
Less than 25 mm	(A) x 0.3												
Less than 50 mm	(A) x 0.1												

The pages are organized by code number, so you can find the code number you need by checking the code numbers printed at the top of the left and right pages.

## SHANK DIAMETER

SHANK  $\phi 3.0$

Indicates the shank diameter of various types of shafted tools.

※ NAKANISHI micro grinders use a collet system to maintain high precision. Please prepare a collet that corresponds to each shank diameter.

## Grit Size (Mesh Size)

#180

This indicates the size (roughness) of the abrasive grains used in various types of polishing / grinding materials. The larger the number, the smaller (finer) the grit size, and conversely, the smaller the number, the larger (coarser) the grit size (roughness). This is the most significant factor that affects the roughness of the finished surface.

- Rough Finishing ..... 46, 54, 60, 70, 80, 90
- Pre Finishing ..... 100, 120, 150, 180
- Middle Finishing ..... 220, 240, 280, 320, 400
- Finishing ..... 500, 600, 700, 800, 1000
- Extra Fine to Mirror Finishes ..... 1200, 1500, 1800, 2000, 3000, 4000, 6000, 8000...

## Maximum Allowable Speed

30,000 min<sup>-1</sup>

Do not exceed the maximum allowable speed. For safety reasons, always use below the indicated allowable speed.

If this is the first time you are using the equipment or tip tool, start with a low speed and gradually increase it to reach the most appropriate speed for use.

Conditions may vary depending on the type, shape, overall length, and wear condition of the tip tool, so please work with constant care.

※ The maximum allowable operating speed is for when the overhang is under 10 mm. If the overhang is more than 10 mm, please reduce the speed.

For details, please refer to "Precautions for use" on page A-3~4.

※ Make sure there are no mechanical defects in the equipment prior to each use.

Actual size illustration (excluding some tools and overall length)

Shank diameter of the tools listed on the facing page

The beginning of the Code Numbers listed on the facing page. (The last number listed is found on the right side.)

## Quantity in Standard Package

1 pc./pack

A standard package is the minimum shipping unit. This number shows the number of pieces in the standard package (bag, box, etc.). Please order the number of packages needed for the desired quantity.

11131~



**Angle Type Grinder  
(Electric / Pneumatic)**  
Exclusive Tools for "MINI ANGLE Type"

NAKANISHI Angle Grinders are available with a wide range of tools for a variety of machining operations, from cutting to grinding, polishing and lapping.

SHANK DIAMETER

SHANK  $\phi 1.6$

MINI Angle Type

**Diamond Burs for Deep Hole Chamfering**

SHANK  $\phi 1.6$  1 pc./pack

Diamond Burs for Deep Hole Chamfering

- Ideal for machining hardened steel, cemented carbide, ceramics, etc.



Diamond abrasive grains

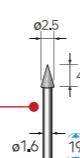

11131

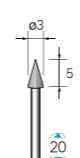

11132

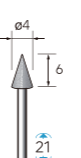

11133

SHANK  $\phi 1.6$  1 pc./pack

Diamond Burs for Deep Hole Chamfering

320,000 min<sup>-1</sup>

#130

$\Delta 30^\circ$

Maximum Allowable Speed

Grit Size



Diamond abrasive grains

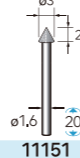

11151

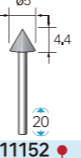

11152



11153



11154



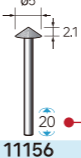

11155

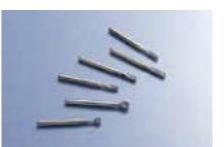

11156

Tools of  $\phi 1.6$  mm shank

Diamond Burs   Carbide Burs   Mounted Abrasive Points   Abrasive Rubber Points

320,000 min<sup>-1</sup>

#140

$\Delta 60^\circ$     $\Delta 90^\circ$     $\Delta 110^\circ$

Overall length

Code No. (Order Number)

P.5-31

Photograph of the basic shape

Note : Specifications may change without notice. The color of the tools in the catalog may differ from the actual color due to printing and other factors.

p.5-3

p.5-4



### SHANK DIAMETER

Original tools that assist the LUSTER's powerful polishing ability to realize a speedy finish.  
We have a wide variety of tools for a wide range of processes from filing to mirror finish.

- ▶ SHANK  $\phi 3.0$
- ▶ SHANK  $\phi 3.2$

Handy Type (reciprocating)  
Tools for LUSTER



### Grindstone Holder

1 pc./pack Maximum clampable thickness 4.5 x width 11 mm

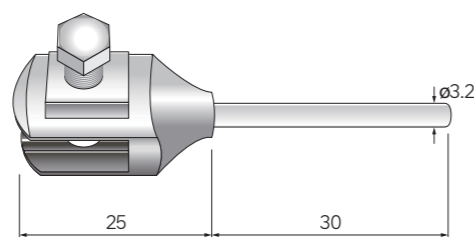
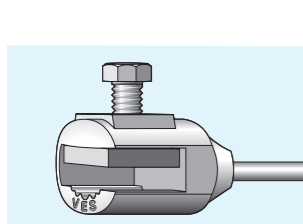

Code No.  
**62502**

1 pc./pack Maximum clampable thickness 11 x width 13.5 mm

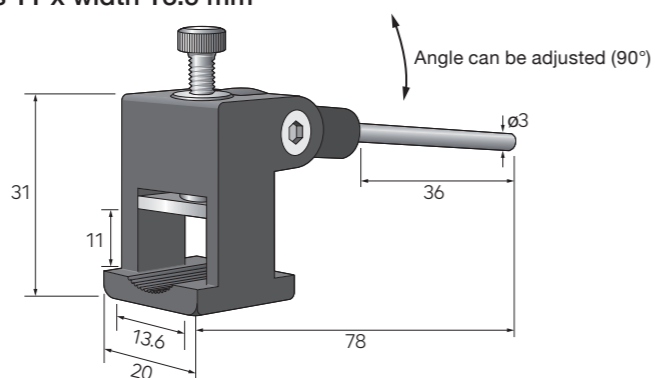

Code No.  
**62505**

### Ceramic Fiber Holder・Grindstone Holder

1 pc./pack Maximum clampable thickness 1 x width 4 mm

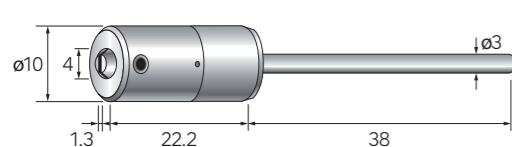

Code No.  
**62506**

Maximum clampable thickness 1 x width 10 mm

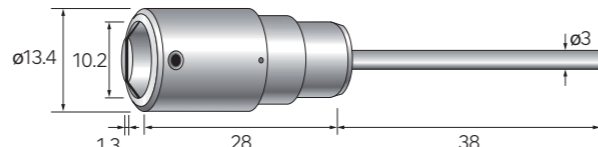

Code No.  
**62508**

Maximum clampable thickness 1 x width 6 mm

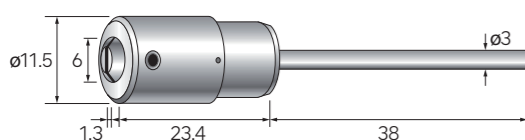

Code No.  
**62507**

Grindstone Holder  
Maximum clampable thickness 3 x width 6 mm

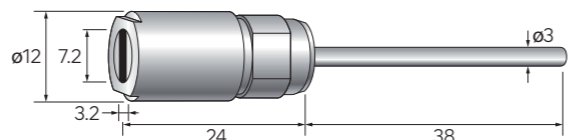

Code No.  
**62509**

### Flat Tip Holder

Attach the following Sandpaper and various polishing sheets.

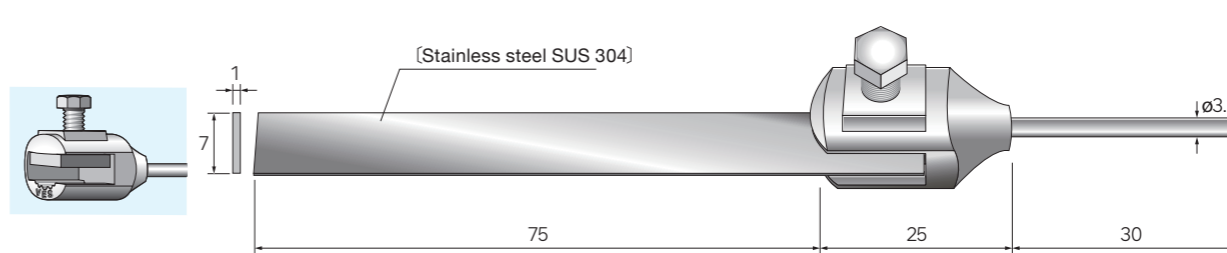

Code No.  
**62512**

### Square Pad Holder

The holder for polishing tips is ideal for polishing the bottom of a box shape.  
The damper function allows the holder to continuously fit the work surface, and the angle can be freely adjusted to continuously capture the work surface for efficient polishing.

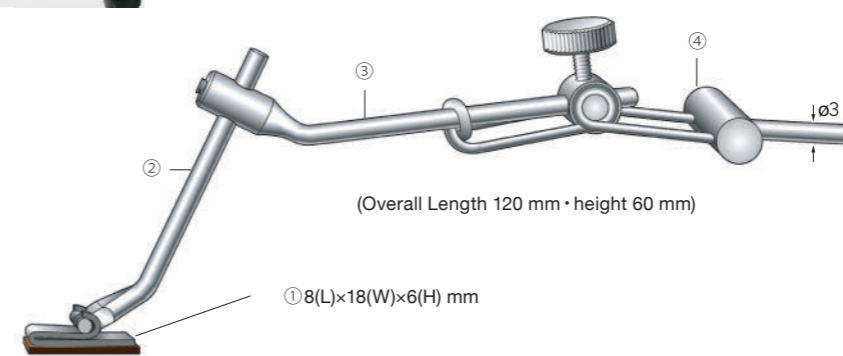

Code No.  
**62521**

Parts	Code No.
① Rectangular Pad	<b>62525</b>
② Rod for Rectangular Pad	<b>62526</b>
③ Angle Rod	<b>62527</b>
④ Tool Holder with Spring	<b>62751</b>

※ Parts can be ordered separately.

### Sandpaper

Please attach to a flat tip holder or rectangular pad holder.

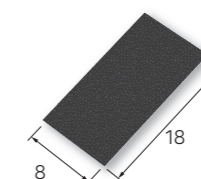

Grit Size	Code No.
# 120	<b>62552</b>
# 320	<b>62555</b>
# 600	<b>62557</b>
# 1000	<b>62559</b>

Adhesive Back

SHANK DIAMETER



Original tools that assist the LUSTER's powerful polishing ability to realize a speedy finish.  
We have a wide variety of tools for a wide range of processes from filing to mirror finish.



- Suitable for finishing of high-hardness metals such as mold steel (removal of hardened electroplated layer, etc.) and heat treated metal. Also suitable for polishing of cemented carbide molds, aluminum molds, and copper alloy molds.
- Ideal for grinding and polishing fine parts and rib slits of various molds for plastics, press, forging, headers, die-casting, etc.
- It can be used for grinding and polishing ceramics, precision electronic parts, and precision mechanical parts.
- It can handle a wide range of processing, from grinding of complex shapes and minute parts to mirror-polished finishes.

Handy Type (reciprocating)  
Tools for LUSTER

### Electroplated Diamond File

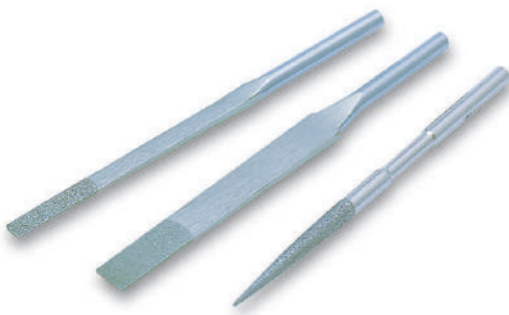

- <Features>
- Diamond abrasive grains are electroplated to the file surface (electroplated coating).
  - The amount of protruding diamond grains is large, and the cutting performance is excellent.
  - We use carefully selected diamond abrasive grains and electroplate them particularly strongly for machine finishing, so they have excellent durability.
  - It is suitable for finishing of high-hardness metals such as mold steel, heat treated metal, cemented carbide, and ceramics, polishing and finishing of various molds, and deburring and correction of machine parts.

SHANK Ø3.0 1 pc./pack Electroplated Diamond File The illustrations on this page are 80% of the actual size.

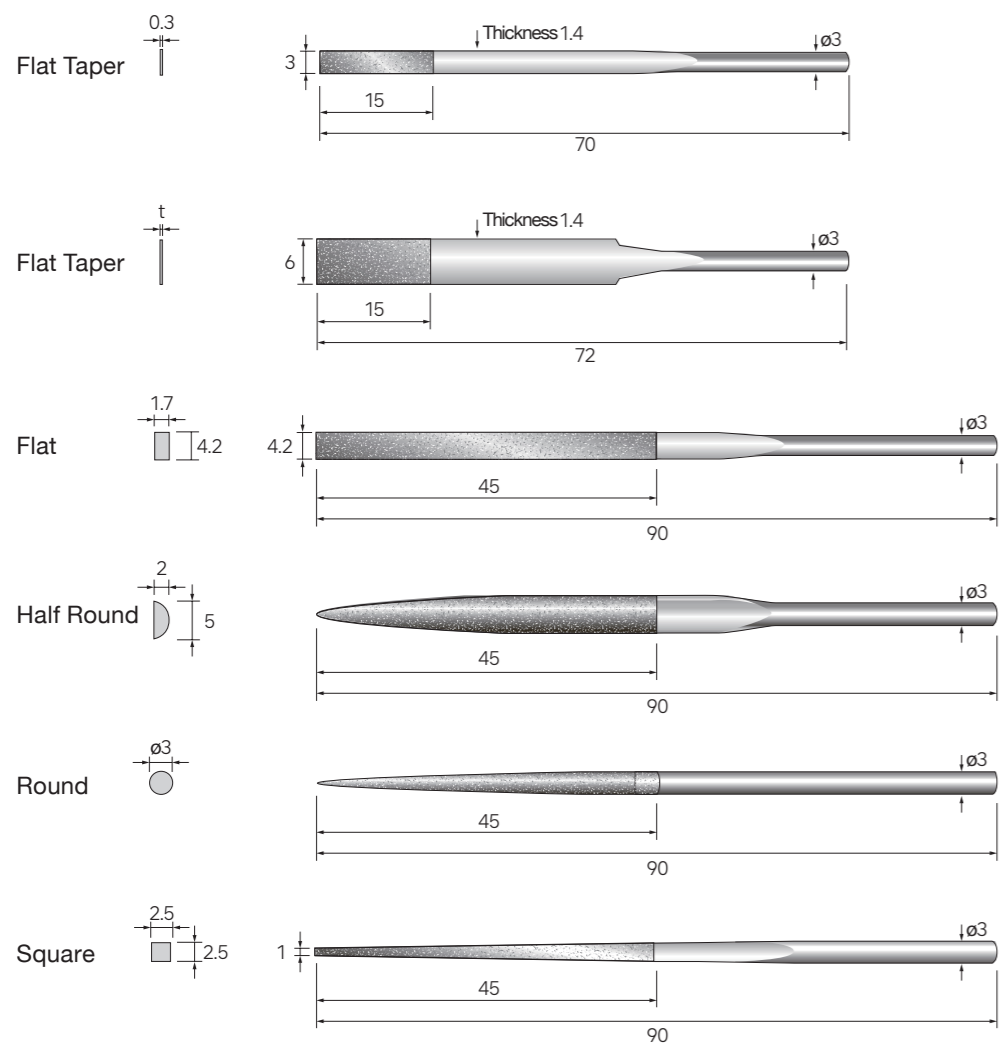

Grit Size	Code No.
#200	62301
#400	62302
#600	62303

Thickness (t)	Grit Size	Code No.
0.45	#200	62305
0.4	#400	62306
0.35	#600	62307

#150 62311

#150 62313

#150 62315

#150 62317

SHANK Ø3.0 1 pc./pack

### Tool Holder with Spring



Common Tools for LUSTER and MINI-LUSTER

- <Features>
- This is a utility holder that allows files and various tools to fit the abrasive tip to the work surface by the spring damper function.
  - The damper function absorbs all the vertical movement (flapping and bouncing) of the abrasive tool during reciprocating motion, enabling ideal reciprocating motion.
  - This makes it possible to apply the grinding tool flatly to the work surface, resulting in highly efficient even and smooth surfaces.
  - Diamond files, various files, ceramic fiber grindstones (Ø3 mm), various lapping sticks, various holders, etc. can be installed and used.

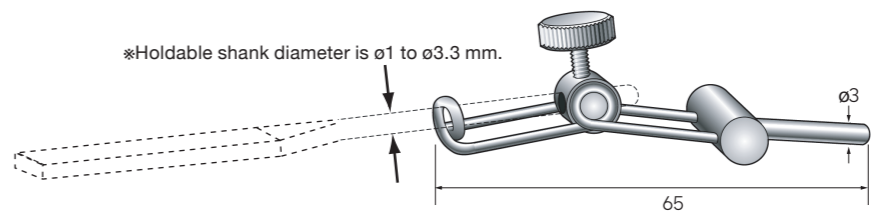

\*Holdable shank diameter is Ø1 to Ø3.3 mm.

Code No.  
62751

# 57301~

SHANK DIAMETER

SHANK  $\phi 3.0$



## Handy Type Reciprocating Grinder (Electric / Pneumatic) Exclusive Tools for "LUSTER"

Original tools that assist the LUSTER's powerful polishing ability to realize a speedy finish. We have a wide variety of tools for a wide range of processes from filing to mirror finish.



# ~57410

Handy Type (reciprocating)  
Tools for LUSTER

### Precision Finishing File (Flat, Round, Square, Triangular, Half-Round)

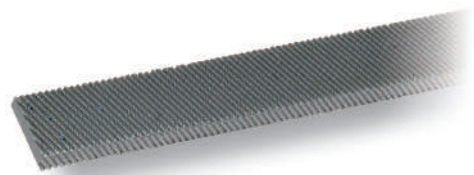

<Features>

- Ideal for precision finishing of general steel, brass, copper alloy, hard resin, etc.
- Carefully selected materials and advanced grading technology provide superior sharpness and durability.
- Speedy finishing is possible by using the LUSTER series (Electric / Pneumatic).

### Coarse File for Plastic and Woodworking (Flat, Round, Square, Triangular, Half-Round)



<Features>

- Ideal for filing wood products, plywood, compressed materials, and plastics.
- It is characterized by its superior sharpness and durability due to its advanced grading technology.
- It can be used with the Luster Series (Electric / Pneumatic) for speedy finishing.

SHANK  $\phi 3.0$  3 pcs./pack

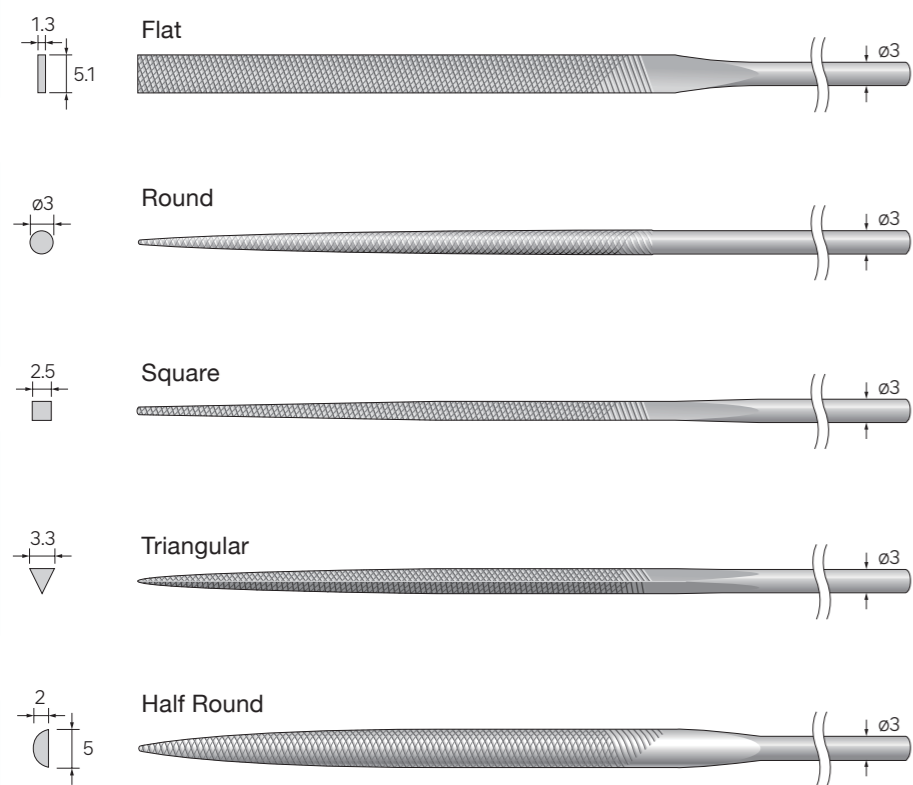

Overall length / 140 mm, Filing area / 70 mm

Medium-Grit		Fine-Grit	
Code No.		Code No.	
57301	Flat	57311	Flat
57302	Round	57312	Round
57303	Square	57313	Square
57304	Triangular	57314	Triangular
57305	Half Round	57315	Half Round

Set of 5 types

Precision Finishing File Medium-Grit Set  
(No.57301~No.57305 Contains 1 pc. each)

No.57309

Precision Finishing File Fine-Grit Set  
(No.57311~No.57315 Contains 1 pc. each)

No.57319

SHANK  $\phi 3.0$  3 pcs./pack

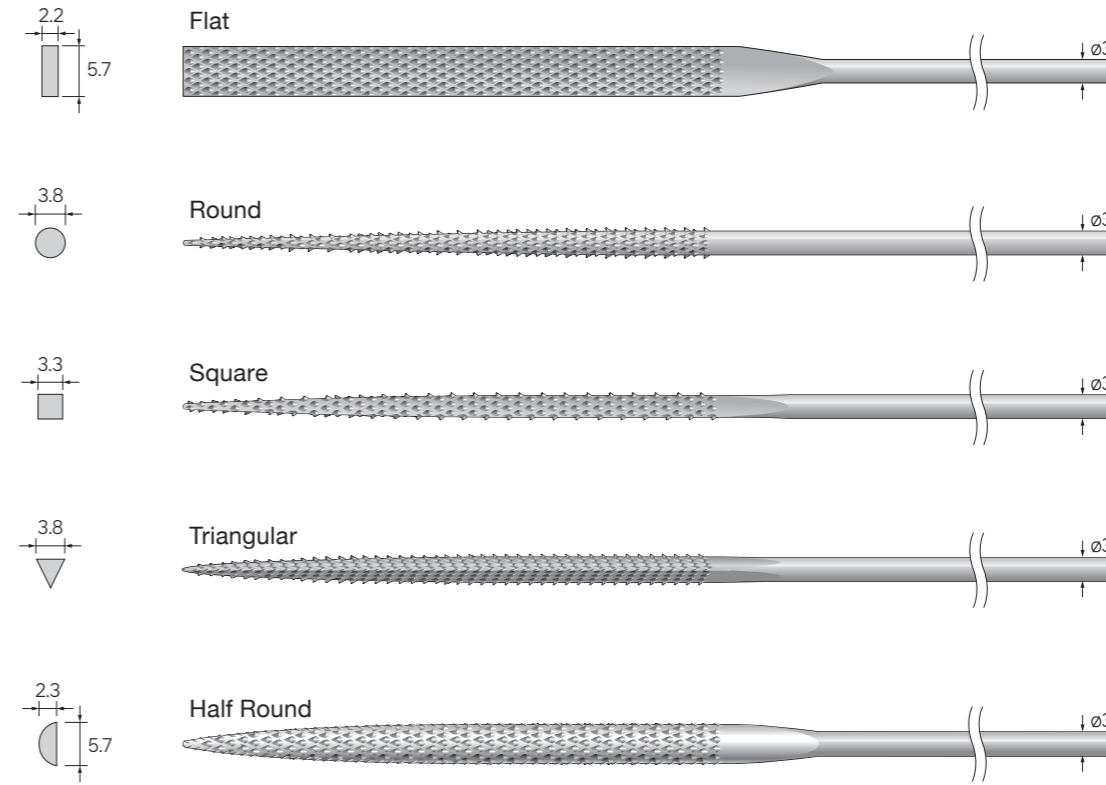

Overall length / 140 mm  
Filing area / 69 mm

Code No.	
57401	Flat
57402	Round
57403	Square
57404	Triangular
57405	Half Round

Set of 5 types

Coarse File Plastic and Woodworking Set  
(No.57401~No.57405 Contains 1 pc. each)

No.57410

# 62506~

SHANK DIAMETER

- SHANK  $\phi 3.0$
- SHANK  $\phi 3.2$



## Pencil Type Reciprocating Grinder (Electric / Pneumatic) Exclusive Tools for Polisher "MINI-LUSTER"

Designed to be easy to use, taking advantage of the features of the lightweight pencil type. The line-up of NAKANISHI's original tools is ideal for delicate and precise abrasive finishing.

# (~62982)

Pencil Type (reciprocating) Tools for MINI-LUSTER

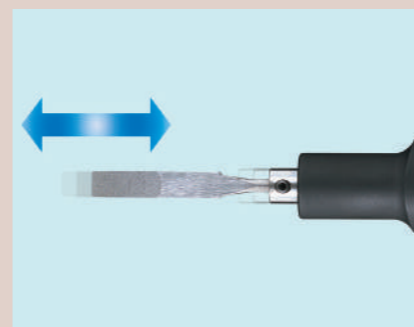

1 pc./pack

### Ceramic Fiber Holder·Grindstone Holder

Maximum clampable thickness 1 x width 4 mm

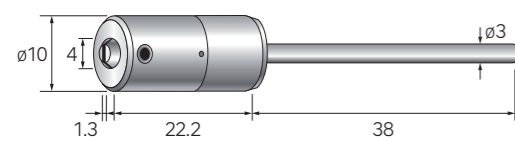

Code No.  
**62506**

Maximum clampable thickness 1 x width 10 mm

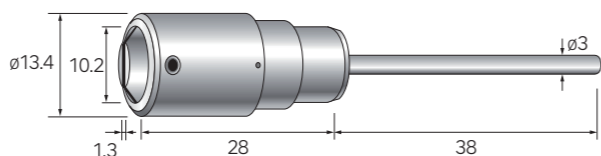

Code No.  
**62508**

Maximum clampable thickness 1 x width 6 mm

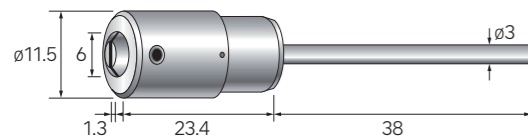

Code No.  
**62507**

Grindstone Holder  
Maximum clampable thickness 3 x width 6 mm

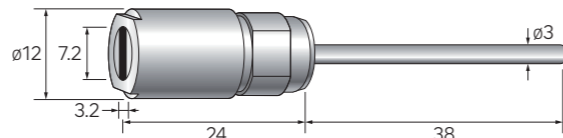

Code No.  
**62509**

Maximum clampable thickness 1 x width 6 mm

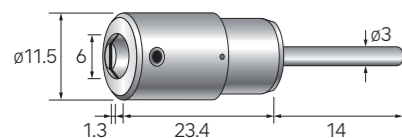

Code No.  
**62510**

2 pcs./pack

### Ceramic Fiber Grindstone

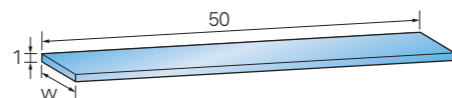
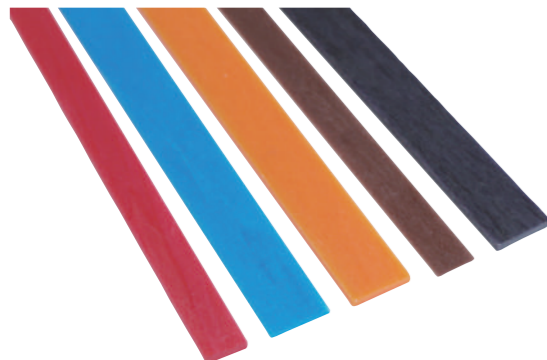

Grit Size	Color	W=4 mm	W=6 mm	W=10 mm
		Code No.	Code No.	Code No.
# 120	Violet	60511	60516	60521
# 220	Brown	60512	60517	60522
# 400	Orange	60513	60518	60523
# 800	Blue	60514	60519	60524
# 1200	Red	60515	60520	60525

1 pc./pack

### Flat Tip Holder

- A variety of polishing tips can be attached to MINI-LUSTER for efficient finish polishing.
- In addition to the polishing tips listed below, a wide range of cut polishing sheets (diamond film, felt sheets, etc.) can be used.
- The compact holder can be mounted on the pencil type MINI-LUSTER in a well balanced manner and is easy to use.

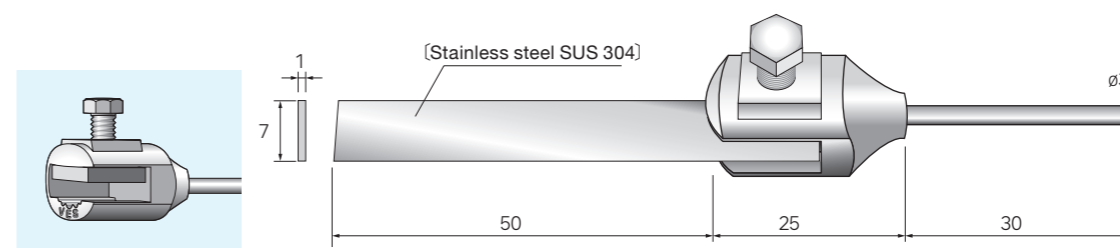

Code No.  
**62982**

100 pcs./pack

### Sandpaper

Please attach to a flat tip holder or rectangular pad holder.

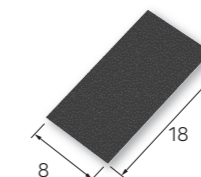

Adhesive Back	
Grit Size	Code No.
# 120	62552
# 320	62555
# 600	62557
# 1000	62559

1 pc./pack

### Tool Holder with Spring

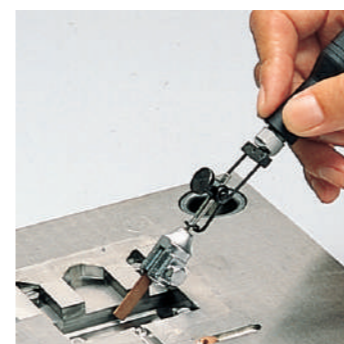

<Features>

- This is a utility holder that allows files and various tools to fit the abrasive tool to the work surface by the spring damper function.
- The damper function absorbs all the vertical movement (flapping and bouncing) of the abrasive tool during reciprocating motion, enabling ideal reciprocating motion.
- This makes it possible to apply the grinding tool flatly to the work surface, resulting in highly efficient, even and smooth surfaces.
- Diamond files, various files, ceramic fiber grindstone ( $\phi 3$  mm), various lapping sticks, various holders, etc. can be installed and used.

\*Holdable shank diameter is  $\phi 1$  to  $\phi 3.3$  mm.

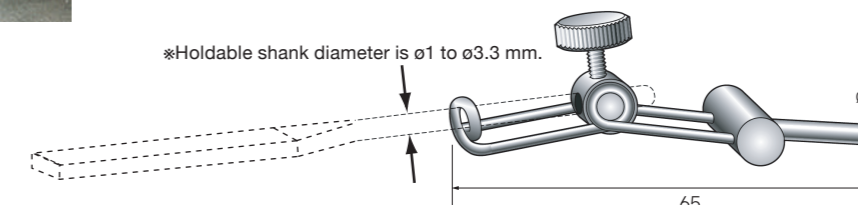

Code No.  
**62751**

# 62801 ~

SHANK DIAMETER

SHANK  $\phi$ 3.0

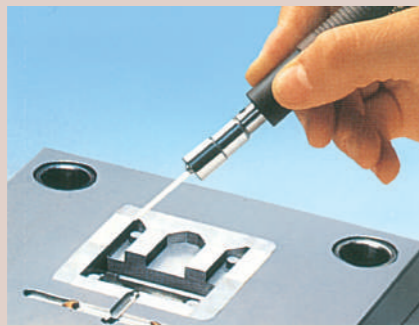

## Pencil Type Reciprocating Grinder (Electric / Pneumatic) Exclusive Tools for Polisher "MINI-LUSTER"

Designed to be easy to use, taking advantage of the features of the lightweight pencil type. The line-up of NAKANISHI's original tools is ideal for delicate and precise abrasive finishing.

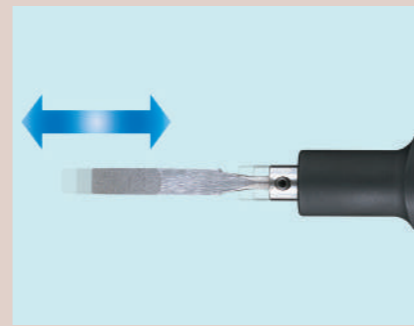

# ~62883

Pencil Type (reciprocating) Tools for MINI-LUSTER

### Electroplated Diamond File



#### <Features>

- Diamond abrasive grains are electroplated to the file surface (electroplated coating).
- The amount of protruding diamond abrasive grains is large, and the cutting performance is excellent.
- We use carefully selected diamond abrasive grains and electroplate them particularly strongly for machine finishing, so they have excellent durability.
- It is suitable for finishing of high-hardness metals such as mold steel, heat treated metal, cemented carbide, and ceramics, polishing and finishing of various molds, and deburring and correction of machine parts.

SHANK  $\phi$ 3.0 1 pc./pack Electroplated Diamond File

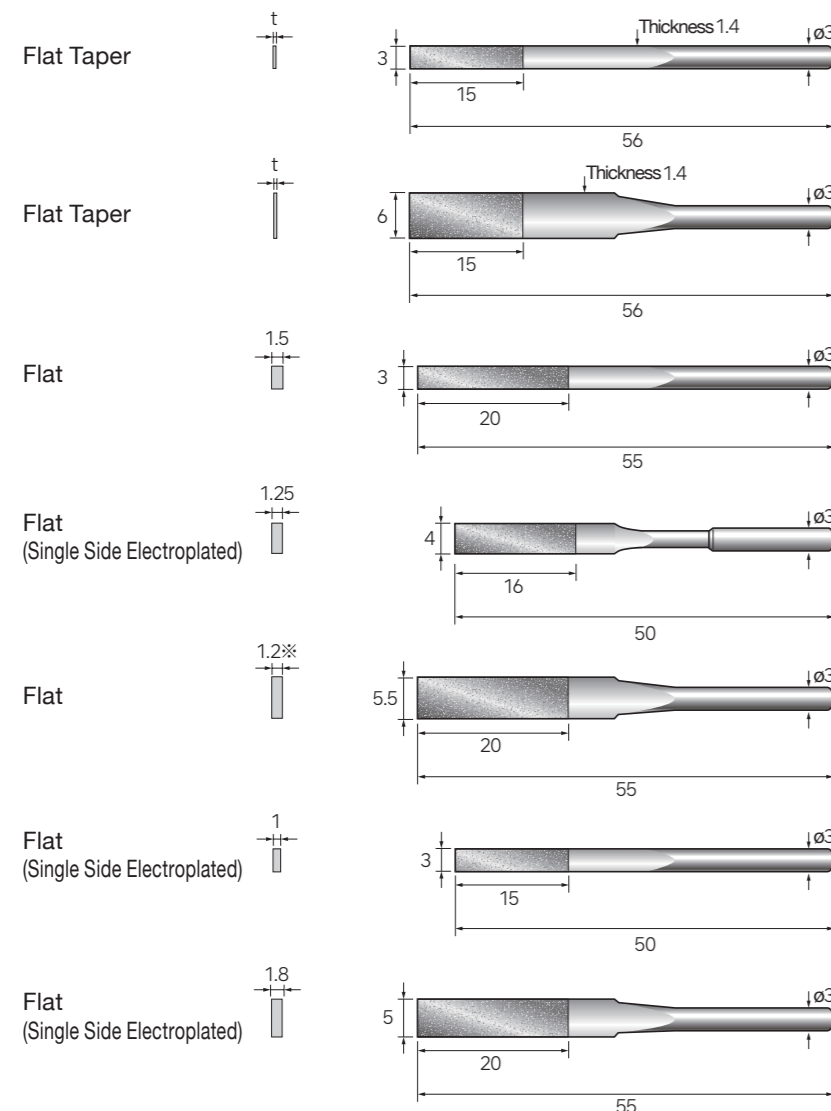

Thickness (t)	Grit Size	Code No.
0.5	#200	62801
0.4	#400	62802
0.35	#600	62803

0.5	#200	62805
0.4	#400	62806
0.35	#600	62807

#150	62811
#200	62812
#400	62813

#100	62814
------	-------

#150	62815
#200	62816
#400	62817

※ Thickness of 62815 is 1.4 mm.

#150	62821
#200	62822
#400	62823

#150	62825
#200	62826
#400	62827

SHANK  $\phi$ 3.0 1 pc./pack Electroplated Diamond File

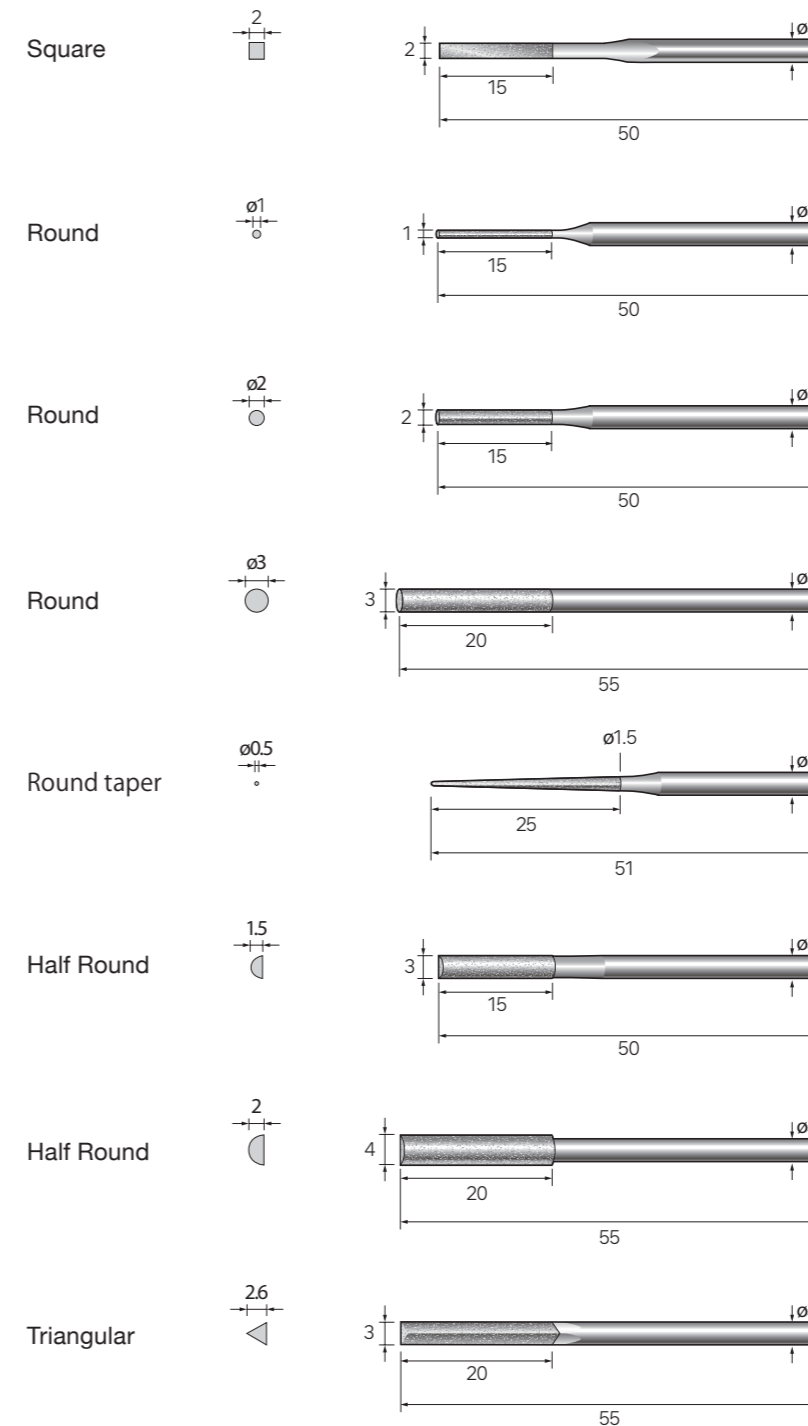

Grit Size	Code No.
#150	62831
#200	62832
#400	62833

#100	62840
#150	62841
#200	62842
#400	62843

#150	62845
#200	62846
#400	62847

#150	62851
#200	62852
#400	62853

#150	62855
#200	62856
#400	62857

#150	62865
#200	62866
#400	62867

#150	62871
#200	62872
#400	62873

#150	62881
#200	62882
#400	62883

▲ For safety reasons, always wear protective equipment such as safety glasses. Use at or below the indicated maximum allowable speed.

(51123~)

SHANK DIAMETER

SHANK  $\phi$ 3.0

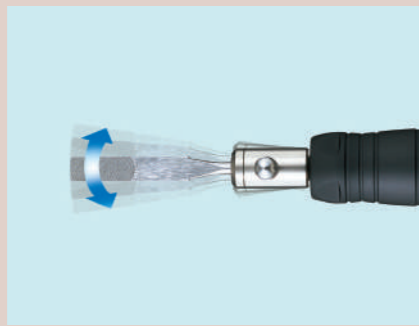

### Pencil Type Swing Polisher (Electric / Pneumatic) Exclusive Tools for "SWING-LUSTER"

The left-right horizontal swinging file swings around narrow areas (ribs), corners, grooves (runners), etc., which cannot be polished with a reciprocating file, to achieve speedy polishing.

(~62827)

Pencil Type (swing) Tools for "SWING-LUSTER"



### Electroplated Diamond File



#### <Features>

- Diamond abrasive grains are electroplated to the file surface (electroplated coating).
- The amount of protruding diamond abrasive grains is large, and the cutting performance is excellent.
- We use carefully selected diamond abrasive grains and electroplate them particularly strongly for machine finishing, so they have excellent durability.
- It is suitable for finishing of high-hardness metals such as mold steel, heat treated metal, cemented carbide, and ceramics, polishing and finishing of various molds, and deburring and correction of machine parts.

SHANK  $\phi$ 3.0 1 pc./pack Electroplated Diamond File

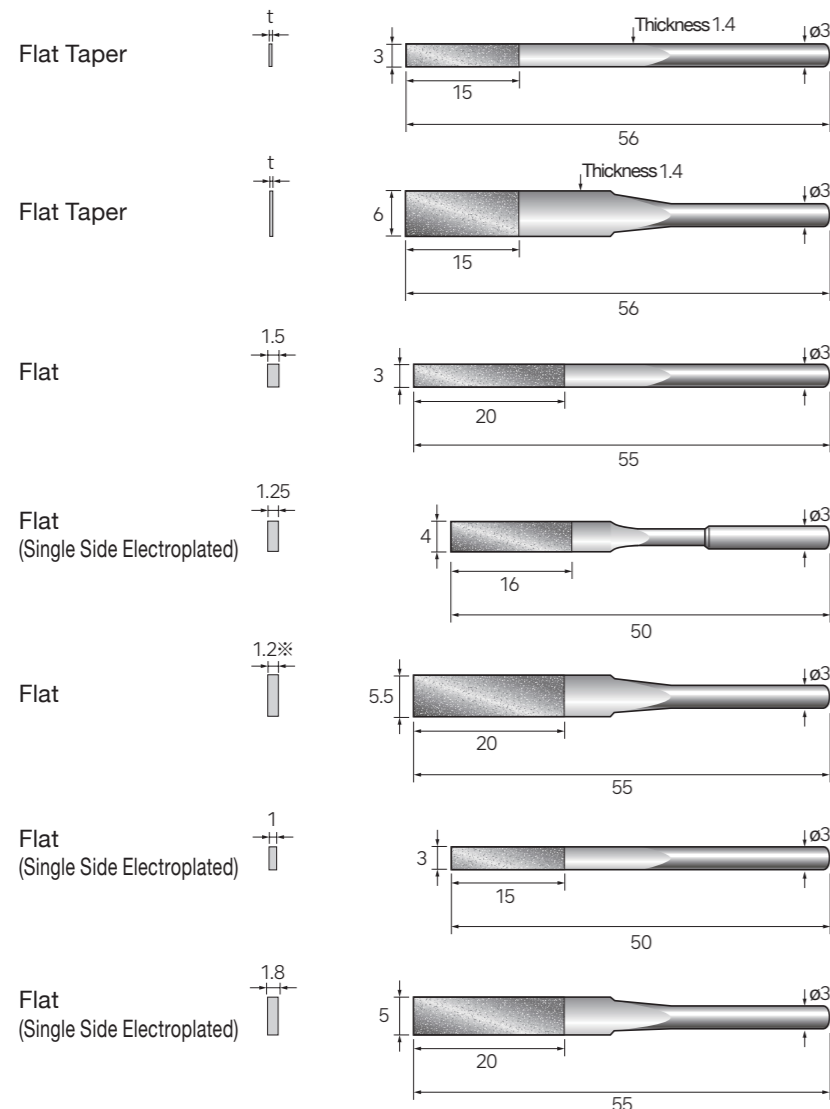

Thickness (t)	Grit Size	Code No.
0.5	#200	62801
0.4	#400	62802
0.35	#600	62803

0.5	#200	62805
0.4	#400	62806
0.35	#600	62807

#150	62811
#200	62812
#400	62813

#100	62814
------	-------

#150	62815
#200	62816
#400	62817

※ Thickness of 62815 is 1.4 mm.

#150	62821
#200	62822
#400	62823

#150	62825
#200	62826
#400	62827

2 pcs./pack

### Flat type 50 mm

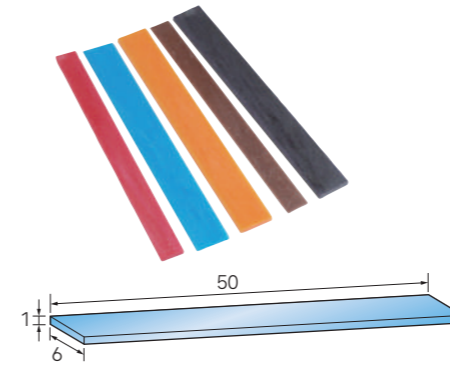

### Ceramic Fiber Grindstone Tip

Thickness 1 mm x width 6 mm		
Grit Size	Color	Code No.
# 120	Violet	60516
# 220	Brown	60517
# 400	Orange	60518
# 800	Blue	60519
# 1200	Red	60520

### Round bar type 50 mm

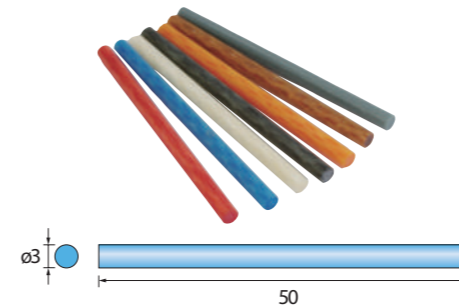

$\phi$ 3 mm		
Grit Size	Color	Code No.
# 220	Gray	60551
# 300	Mazenta	60552
# 400	Orange	60553
# 600	Black	60554
# 800	Blue	60555
# 1000	White	60556
# 1200	Red	60557

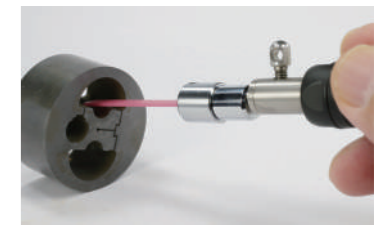

With 6 mm wide flat tip



With  $\phi$ 3 mm round bar

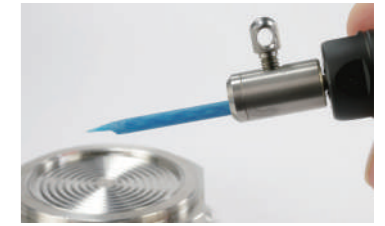

With sharpened tip of round bar

SHANK  $\phi$ 3.0 1 pc./pack

### Ceramic Fiber Holder

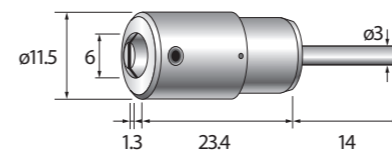

Max. clampable thickness 1 mm x width 6 mm

Code No.

62510

SHANK  $\phi$ 3.0 1 pc./pack

### Ceramic Fiber Brush

The grindstone is now in brush form.



Brush diameter	Brush length	Overall length	Finishing (Pink)	Middle Finishing (Red)	Rough Finishing (Blue)
$\phi$ 2	15	52*	51123	51133	51141
$\phi$ 2.5	15	52*	51124	51134	51142

※Blue's overall length is 50 mm.

▲ For safety reasons, always wear protective equipment such as safety glasses. Use at or below the indicated maximum allowable speed.

# 64101~

## Angle Type Grinder (Electric / Pneumatic) Exclusive Tools for "Angle Type"

# ~64274

SHANK DIAMETER

NAKANISHI Angle Grinders are available with a wide range of tools for a variety of machining operations, from cutting to grinding, polishing and lapping.

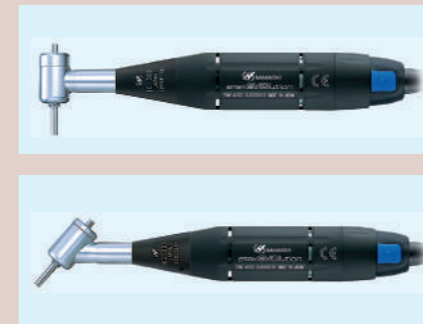
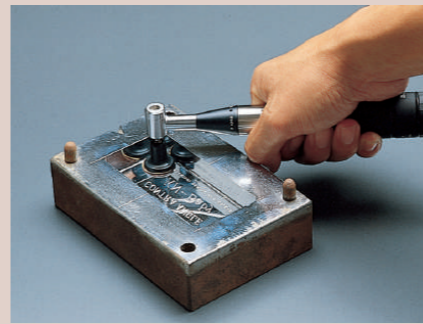

Angle Type



### Special Rubber Pads for Abrasive and Felt Discs

- It is used by attaching various types of polishing discs.
- The elasticity of the rubber makes it ideal for finishing flat and curved surfaces.

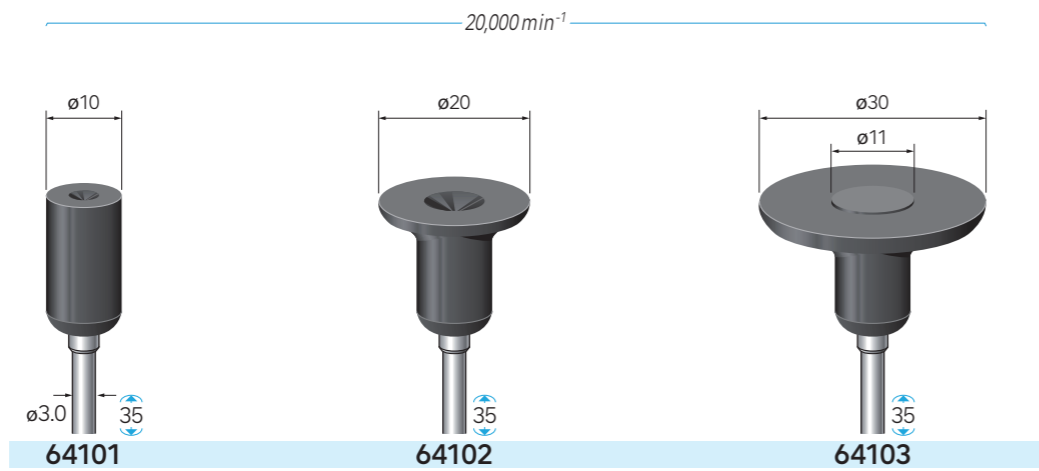

### Sandpaper Discs (paper base type)

- Suitable for metal, woodwork, painted surfaces and putty polishing
- Use in dry conditions



		Adhesive Back		
Grit Size		Ø11	Ø21	Ø31
# 80	64201	64211	64221	
# 120	64202	64212	64222	
# 180	64203	64213	64223	
# 240	64204	64214	64224	
# 320	64205	64215	64225	
# 400	64206	64216	64226	
# 600	64207	64217	64227	



### Sandpaper Discs (fabric base type)

- Ideal for metalworking
- Excellent durability
- Use in dry conditions

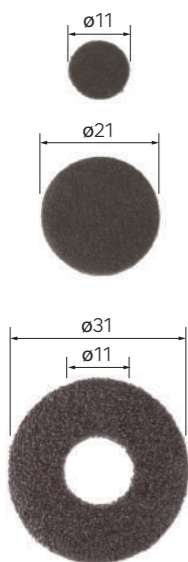

		Adhesive Back		
Grit Size		Ø11	Ø21	Ø31
# 60	64111	64121	64141	
# 80	64112	64122	64142	
# 120	64113	64123	64143	
# 180	64114	64124	64144	
# 240	64115	64125	64145	
# 320	64116	64126	64146	
# 400	64117	64127	64147	
# 600	64118	64128	64148	



### Zirconia Disks

- These discs are specially coated with zirconia abrasive grains to provide excellent cutting performance and durability for difficult-to-machine materials.
- Ideal for machining metals such as aluminium, stainless steel, copper alloys and brass, which are prone to clogging.



		Adhesive Back		
Grit Size		Ø11	Ø21	Ø31
# 60	64251	64261	64271	
# 80	64252	64262	64272	
# 120	64253	64263	64273	
# 150	64254	64264	64274	

# 64331 ~

## Angle Type Grinder (Electric / Pneumatic) Exclusive Tools for "Angle Type"

SHANK DIAMETER

NAKANISHI Angle Grinders are available with a wide range of tools for a variety of machining operations, from cutting to grinding, polishing and lapping.



# ~64432

Angle Type

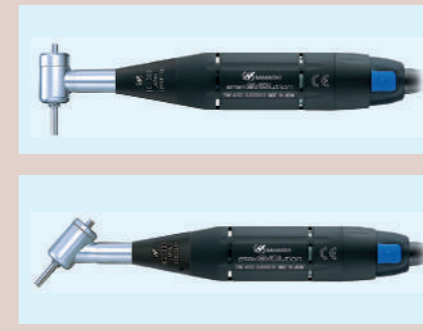

20 pcs./pack

### Felt Discs

- Ideal for use in combination with various abrasives (diamond compound, polishing compound) for finish polishing.
- Made from 100% high quality sheep's wool, with moderate elasticity and sufficient durability for repeated polishing operations.
- High wool density ensures that abrasives and abrasive grains are held in place and the surface is polished.

Adhesive Back

Product name	ø11	ø21	ø31
Felt Discs (1 mm thick) Soft	<b>64331</b>	<b>64332</b>	<b>64333</b>
Felt Discs (2 mm thick) Soft	<b>64335</b>	<b>64336</b>	<b>64337</b>

\* Sheeted types are available.

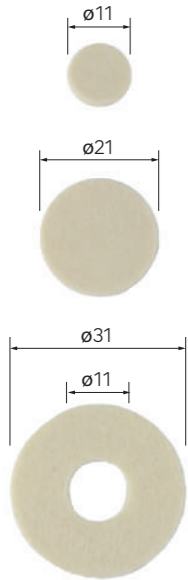

SHANK Ø3.0 5 pcs./pack

### Rubber grinding wheel disc with shaft (Integrated rubber pad)

- The newly developed special rubber holds the abrasive grains with the right amount of hardness and boasts exceptional polishing ability.
- The grinding wheel part is integrally moulded into the rubber pad for superior workability.
- Highly efficient finishing of flat and curved surfaces with a soft touch.

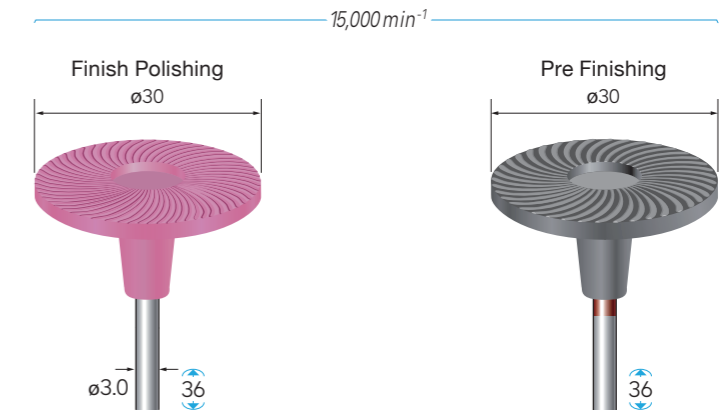

#### Finish Polishing

Grit Size	Color	WA abrasive grains	GC abrasive grains
# 80	Pink	<b>64411</b>	—
# 80	Purple	—	<b>64421</b>
# 120	Blue	<b>64412</b>	<b>64422</b>
# 180	Yellow	<b>64413</b>	—
# 180	Green	—	<b>64423</b>
# 220	Green	<b>64414</b>	<b>64424</b>
# 320	Purple	<b>64415</b>	<b>64425</b>
# 500	Orange	<b>64416</b>	—
# 500	Brown	—	<b>64426</b>

#### Pre Finishing (Excellent grindability)

Grit Size	Color	WA abrasive grains
# 80	Black(Red line)	<b>64431</b>
# 120	Black(Blue line)	<b>64432</b>



## Angle Type Grinder (Electric / Pneumatic) Exclusive Tools for "Angle Type"

NAKANISHI Angle Grinders are available with a wide range of tools for a variety of machining operations, from cutting to grinding, polishing and lapping.

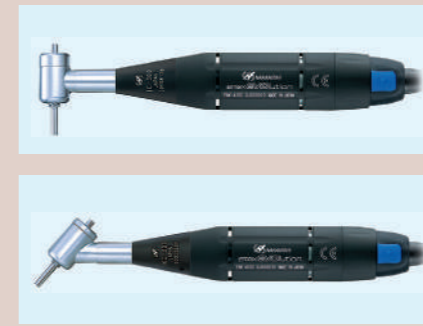

Angle Type

1 pc./pack

### Diamond Discs (Full electroplated surface)

The base material is an ultra-thin copper alloy, with diamond abrasive grains electroplated over the entire surface.

- The metal base material has good electrodeposition plating conditions and adheres diamond abrasive grains uniformly and most firmly.
- Very good sharpness and durability.

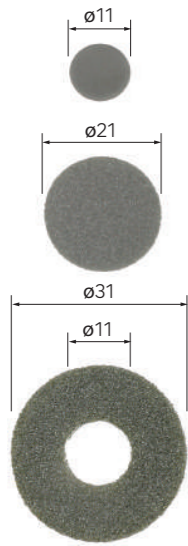

Adhesive Back

Grit Size	ø11	ø21	ø31
# 100	64451	64461	64471
# 140	64452	64462	64472
# 200	64453	64463	64473
# 280	64454	64464	64474
# 400	64455	64465	64475
# 600	64456	64466	64476
# 800	64457	64467	64477
# 1000	64458	64468	64478

\* Sheeted types are available.

3 pcs./pack

### Resin Bond Diamond Discs

Diamond abrasive grains are mixed with resin bond and coated on the resin base material.

- The resin component provides a uniform and stable finished surface and a soft grinding feel.
- ※ This resin bond type requires dressing only for the first use.  
The cutting edges of the abrasive grains are exposed by lightly shaving the surface with a grindstone or diamond file.



Adhesive Back

Grit Size	ø11	ø21	ø31
# 80	64531	64541	64551
# 120	64532	64542	64552
# 180	64533	64543	64553
# 240	64534	64544	64554
# 400	64535	64545	64555
# 800	64537	64547	64557
# 1000	64538	64548	64558
# 2000	64539	64549	64559

1 pc./pack

### Diamond Discs (Dot electroplated type for wet applications)

Nickel alloy pellets with diamond electrodeposition are strongly bonded to the Resin base material.

- The dot pattern is characterized by its strong grinding performance.
- Dot spaces allow chips and grinding fluid to flow smoothly.
- The resin base material is made of a fiber-filled resin that excels in flexibility and toughness.

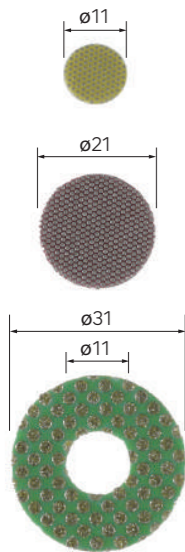

Adhesive Back

Grit Size	Color	ø11	ø21	ø31
# 60	Green	64501	64511	64521
# 120	Black	64502	64512	64522
# 200	Red	64503	64513	64523
# 400	Yellow	64504	64514	64524
# 800	Gray	64505	64515	64525

\* Sheeted types are available.

# 11131~

SHANK DIAMETER

SHANK  $\phi 1.6$

MINI Angle Type



## Angle Type Grinder (Electric / Pneumatic) Exclusive Tools for "MINI ANGLE Type"

NAKANISHI Angle Grinders are available with a wide range of tools for a variety of machining operations, from cutting to grinding, polishing and lapping.



## Compact Handy Belt Sander (Electric / Pneumatic) Exclusive Tools for "FINE BELT SANDER"

Powerful belt grinding power.  
High-quality special belt for processing as desired.  
The precise, lightweight, and compact NAKANISHI Belt Sander functions at 100%.

# ~65027

Fine Belt Sander

### Diamond Burs for Deep Hole Chamfering

SHANK  $\phi 1.6$  1 pc./pack Diamond Burs for Deep Hole Chamfering

- Ideal for machining hardened steel, cemented carbide, ceramics, etc.

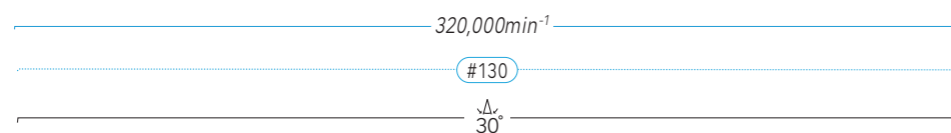
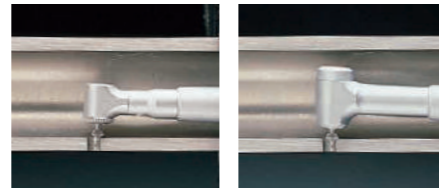

Diamond abrasive grains

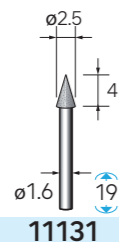

11131

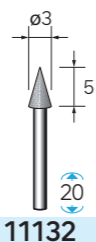

11132

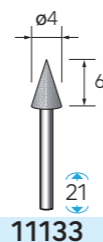

11133

SHANK  $\phi 1.6$  1 pc./pack Diamond Burs for Deep Hole Chamfering

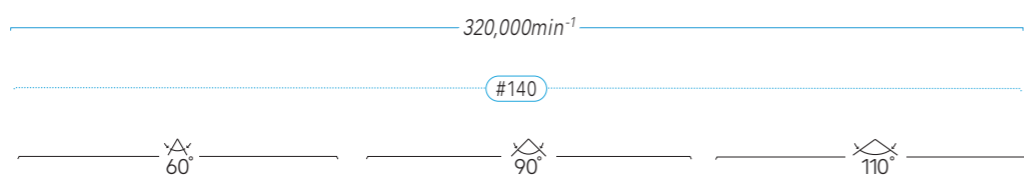

Diamond abrasive grains

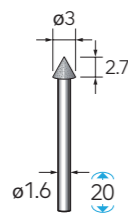

11151

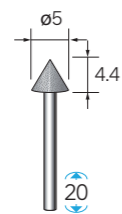

11152

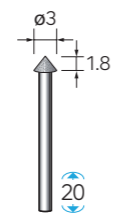

11153

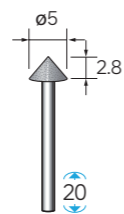

11154

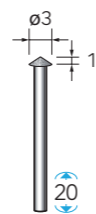

11155

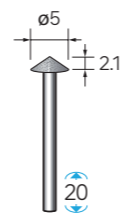

11156

Tools of  $\phi 1.6$  mm shank

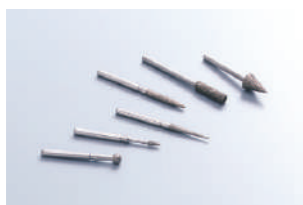

Diamond Burs



Carbide Burs

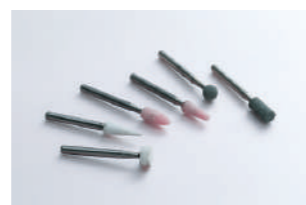

Mounted Abrasive Points



Abrasive Rubber Points

### Sand Belt

30 pcs./pack Circumference 300 mm



- High quality Sanding Belt with excellent grindability and durability.
- Highly efficient grinding with a soft touch and less grain dropout even at high rim speeds.

● Assorted set for Pre Finishing (● mark)  
4 Grit sizes (10 pcs. each)  
Total 40 pcs. per pack

No.64931

● Assorted set for Finishing (● mark)  
4 Grit sizes (10 pcs. each)  
Total 40 pcs. per pack

No.64932

For metal processing

Grit Size	W=4 mm			W=6 mm			W=8 mm		
	Code No.	Code No.	Code No.	Code No.	Code No.	Code No.	Code No.	Code No.	
# 80	64901	64911	64921	64901	64911	64921	64901	64911	64921
# 120	64902	64912	64922	64902	64912	64922	64902	64912	64922
# 180	64903	64913	64923	64903	64913	64923	64903	64913	64923
# 240	64904	64914	64924	64904	64914	64924	64904	64914	64924
# 320	64905	64915	64925	64905	64915	64925	64905	64915	64925
# 400	64906	64916	64926	64906	64916	64926	64906	64916	64926
# 600	—	—	64927	—	—	64927	—	—	64927
# 800	—	—	64928	—	—	64928	—	—	64928

### Zirconia Belt

30 pcs./pack Circumference 300 mm



- Ideal for machining metals such as aluminium, stainless steel, copper alloys and brass, which are prone to clogging.
- These belts are specially coated with zirconia abrasive grains to provide excellent durability for difficult-to-grind materials.

● Assorted set 8 mm width  
All 3 Grit sizes (10 pcs. each)  
Total 30 pcs.

No.64975

Grit Size	Code No.
# 80	64971
# 100	64972
# 120	64973

### Diamond Belt

3 pcs./pack Hard type (circumference 300 mm)



- Excellent cutting performance enables high productivity and cost reduction.
- Excellent wear resistance and durability, and stable finish machined surfaces can be maintained.
- Suitable for highly efficient machining of carbide, hardened steel, mold steel, special steel, ceramics, FRP, carbon fiber, glass, stone, and difficult-to-machine materials.

● Assorted set 8 mm width  
All 5 Grit sizes (1 pc. each)  
Total 5 pcs.

No.65019

Hard type

Grit Size	Code No.	Grit Size	Code No.
# 80	65011	# 320	65015
# 120	65012	# 600	65017
# 240	65014		

3 pcs./pack Soft type (circumference 300 mm)



● Assorted set 8 mm width  
All 8 Grit sizes (1 pc. each)  
Total 8 pcs.

No.65030

Soft type

Grit Size	Code No.	Grit Size	Code No.
# 120	65021	# 400	65028
# 180	65022	# 600	65025
# 240	65023	# 800	65026
# 320	65024	# 1000	65027