

FELT BOBS

SHANK $\phi 2.34, \phi 3.0$

5 pcs./pack Cotton Bobs

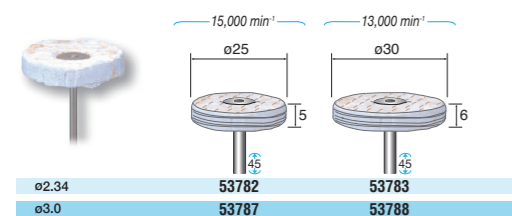

3 pcs./pack

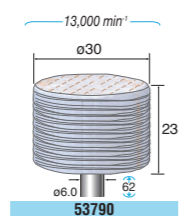

5 pcs./pack Dark Brown Cotton Bobs

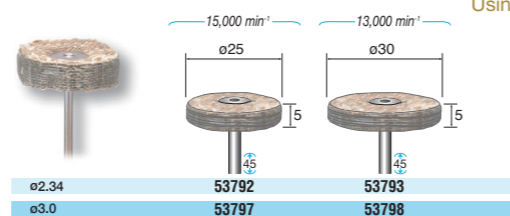

For metal semi-finishing. Using polishing materials.

SHANK $\phi 2.34, \phi 3.0$

5 pcs./pack Sisal Bobs

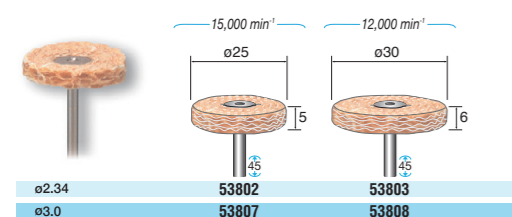

3 pcs./pack

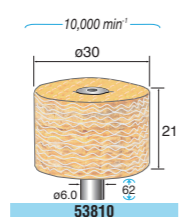

SHANK $\phi 3.0$

7 pcs./pack Polishing Piled Bobs Assorted Set

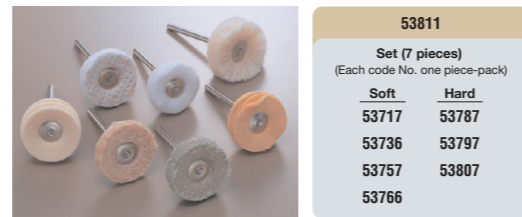

2 pcs./pack Polishing Compound (Solid Type)

For Metals	Alumina for metal pre-finishing (white rouge)	55341	◆ Aluminum, stainless steel, brass, chrome, etc.
	Tripoli for metal pre-finishing (red rouge)	55342	◆ Iron, aluminum, etc.
	Chrome oxide for metal finishing (blue rouge)	55343	◆ Precious metals, aluminum, stainless steel, brass, copper alloys, etc.
For Resins	For resin pre-finishing (white rouge)	55345	◆ For synthetic resins and coated surfaces
	For resin finishing (white rouge)	55346	◆ For synthetic resins and acrylics for coated surfaces

SHANK $\phi 1.3$

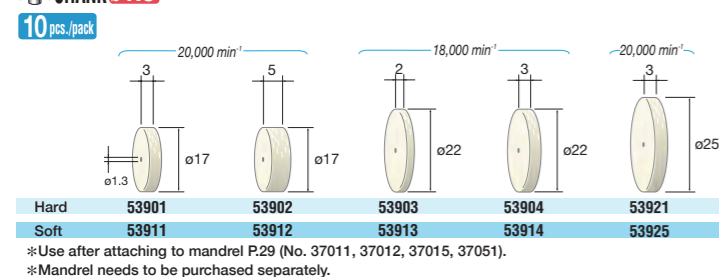

SHANK $\phi 3.0$

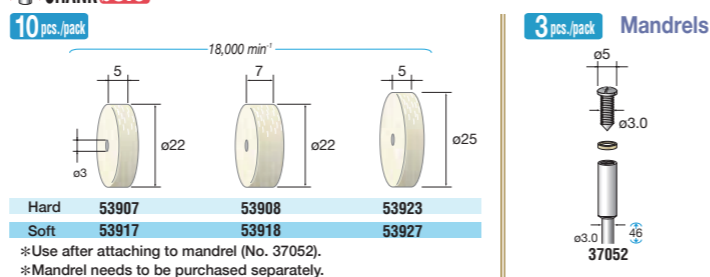

SHANK $\phi 1.3$

10 pcs./pack Knife Edge Type

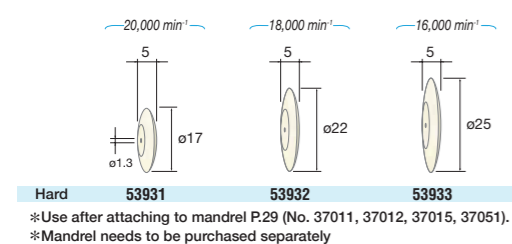

SHANK $\phi 2.34$

16 pcs./pack Polishing Piled Bobs Assorted Set



SHANK $\phi 3.0$

16 pcs./pack Polishing Piled Bobs Assorted Set



ABRASIVE COMPOUNDS & POLISHING TOOLS

1 pc./pack Diamond Compounds

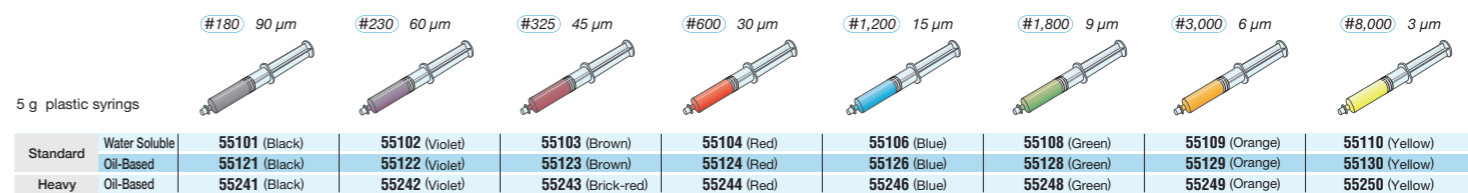

The color in the illustration is the standard type.
* The micron grades indicate median range of grain diameters. * We recommend weak solutions for grinding, polishing, etc.

1 pc./pack Diamond Compounds

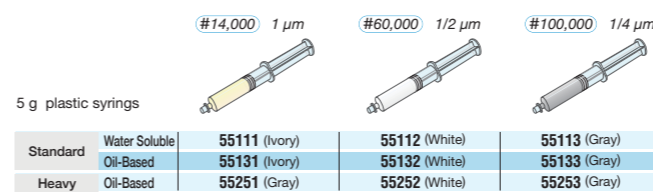

The color in the illustration is the standard type.
* The micron grades indicate median range of grain diameters.
* We recommend weak solutions for grinding, polishing, etc.

1 pc./pack Diamond Micron Powder

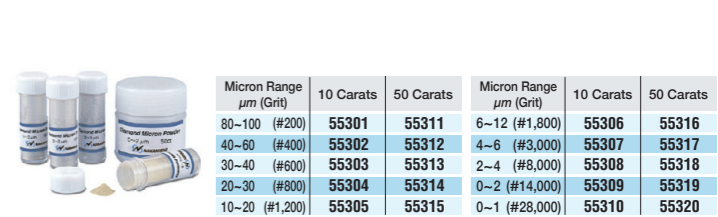

1 pc./pack Diamond Compound, Weak Solution



2 pcs./pack Polishing Compound (Solid Type)

For Metals	Alumina for metal pre-finishing (white rouge)	55341	◆ Aluminum, stainless steel, brass, chrome, etc.
	Tripoli for metal pre-finishing (red rouge)	55342	◆ Iron, aluminum, etc.
	Chrome oxide for metal finishing (blue rouge)	55343	◆ Precious metals, aluminum, stainless steel, brass, copper alloys, etc.
For Resins	For resin pre-finishing (white rouge)	55345	◆ For synthetic resins and coated surfaces
	For resin finishing (white rouge)	55346	◆ For synthetic resins and acrylics for coated surfaces

10 pcs./pack Wood Lapping Sticks (Total Length 150 mm)

◆ Wood lapping sticks retain abrasive compounds very well and are ideal for very fine polishing.

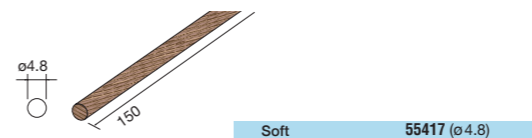

1 pc./pack Diamond Ceramic Fiber Grindstone (Total Length 100 mm)

Grit	Color	55471	55481	55485	55491
#200	Black	55471	55481	55485	55491
#400	Gray	55472	55482	55486	55492
#600	Green	55473	55483	55487	55493

1 pc./pack Ceramic Fiber Grindstone (Total Length 100 mm)

Grit	Color	55514	55524	55534	55554	55574	55584	55594	55604
#180	Ivory	55514	55524	55534	55554	55574	55584	55594	55604
#300	Brown	55515	55525	55535	55555	55575	55585	55595	55605
#400	Orange	55516	55526	55536	55556	55576	55586	55596	55606
#600	Black	55517	55527	55537	55557	55577	55587	55597	55607
#800	Blue	55518	55528	55538	55558	55578	55588	55598	55608
#1000	White	55519	55529	55539	55559	55579	55589	55599	55609
#1200	Pink	55520	55530	55540	55560	55580	55590	55600	55610

ABRASIVE COMPOUNDS & POLISHING TOOLS

1 pc./pack Ceramic Fiber Grindstone (Total Length 100 mm)

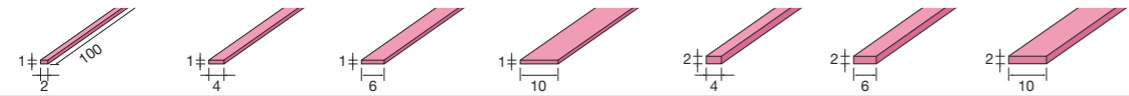

Grit	Color	55614	55624	55654	55684	55724	55744	55764
#180	Ivory	55614	55624	55654	55684	55724	55744	55764
#300	Brown	55615	55625	55655	55685	55725	55745	55765
#400	Orange	55616	55626	55656	55686	55726	55746	55766
#600	Black	55617	55627	55657	55687	55727	55747	55767
#800	Blue	55618	55628	55658	55688	55728	55748	55768
#1000	White	55619	55629	55659	55689	55729	55749	55769
#1200	Pink	55620	55630	55660	55690	55730	55750	55770

2 pcs./pack Special Hand Holder For Ceramic Fiber Grindstones

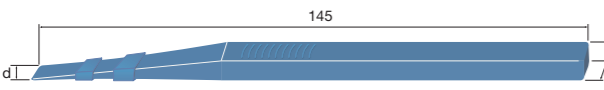

Flat (hold thickness 0.5~2 mm) Weight: 13 g

d	55461
For 2 mm width	55461
For 4 mm width	55462
For 6 mm width	55463
For 10 mm width	55464

4 Types (for 2, 4, 6 and 10 mm width) 55465

Abrasive Stone Sticks with high quality performance. They are highly effective for polishing.



1 pc./pack Rounded Hand Holder (Pin Vice)

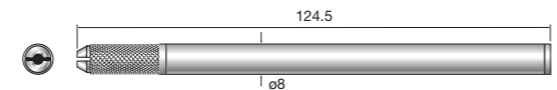

Weight: 22 g

• Attachable shank diameter is $\phi 2.7\text{--}3.0$ mm

$\phi 3$ mm **57631**

6 pcs./pack WA Abrasive Fiber Grindstone

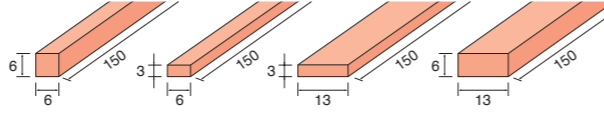

Grit	56156	56161	56166
#150	56156	56161	56166
#220	56122	56157	56162
#320	56123	56158	56163
#400	56124	56159	56164
#600	56125	56160	56165

6 pcs./pack WA Abrasive Fiber Grindstone

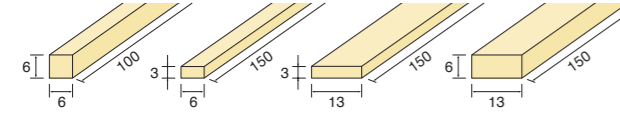

Grit	56231	56241	56245
#120	56231	56241	56245
#180	56217	56232	56246
#220	56218	56233	56247
#320	56219	56234	56248

6 pcs./pack WA Abrasive Fiber Grindstone

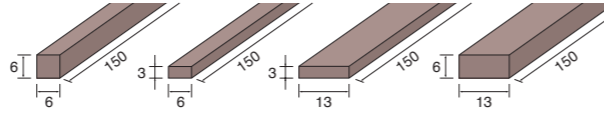

Grit	56341	56361	56371	56381
#100	56341	56361	56371	56381
#120	56342	56362	56372	56382
#180	56343	56363	56373	56383
#320	56345	56365	56375	56385
#600	56346	56366	56376	56386

6 pcs./pack GC/Sic Abrasive Fiber Grindstone

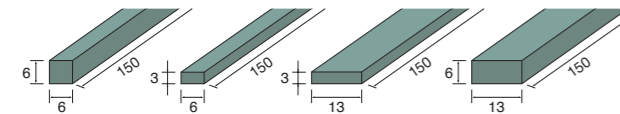

Grit	56417	56432	56437	56442
#240	56417	56432	56437	56442
#320	56418	56433	56438	56443
#400	56419	56434	56439	56444
#600	56420	56435	56440	56445

1 pc./pack Electroplated Diamond Sheet (Dot-Pattern Electroplated Type)

• Strongly bonded diamond-electroplated nickel alloy sheets.

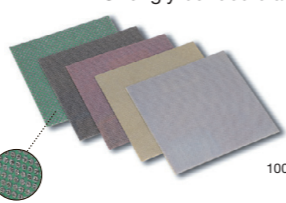

Grit	Grain Diameter	Color	56701
# 60	250 μ	Green	56701
# 120	125 μ	Black	56702
# 200	74 μ	Red	56703
# 400	40 μ	Yellow	56704
# 800	20 μ	Gray	56705

Adhesive Back

1 pc./pack Electroplated Diamond Sheet (Fully Electroplated Type)

• Ultra-thin copper alloy is used for base material. Diamond abrasive is electroplated on the full sheet.

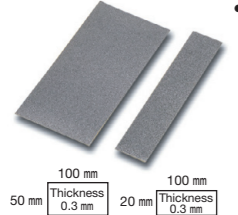

Grit	Size (mm)	56731	56741	Grit	Size (mm)	56736	56746
# 120	100 x 20	56731	56741	# 600	100 x 20	56736	56746
# 150	100 x 50	56732	56742	# 800	100 x 50	56737	56747
# 200	100 x 50	56733	56743	# 1,200	100 x 50	56738	56748
# 300	100 x 50	56734	56744	# 1,800	100 x 50	56739	56749
# 400	100 x 50	56735	56745				

Adhesive Back

ABRASIVE COMPOUNDS & POLISHING TOOLS

1 pc./pack Diamond Lapping Film (Film Coated Type)

• Fine grain diamond is coated on a strong polyester film.



Grit	Grain Diameter	Color	56802
# 400	40 μ	Ivory	56802
# 800	25 μ	Ivory	56804
# 1,000	15 μ	Ivory	56805
# 1,500	12 μ	Ivory	56806
# 3,000	6 μ	Ivory	56807

Adhesive Back

1 pc./pack Felt Sheet

• Ideal for fine finishing with various abrasive compounds.



Thickness	56901
1 mm	56901
2 mm	56902
3 mm	56903

Adhesive Back

1 pc./pack Abrasive Embedded Felt Sheet

• Chrome oxide (green rouge) is embedded into the felt sheet.

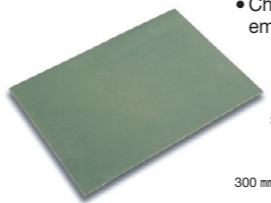

Thickness	56911
1 mm	56911

5 pcs./pack Lapping Film Sheet

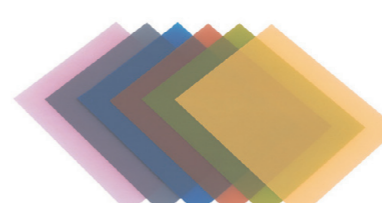

Grit	Grain Diameter	Color	56961
# 320	50 μ	Pink	56961
# 400	40 μ	Ivory	56962
# 600	30 μ	Green	56963
# 800	20 μ	Blue	56964
# 1,000	15 μ	Purple	56965
# 1,200	12 μ	Gley	56966
# 1,500	10 μ	Yellow Ocher	56967
# 3,000	5 μ	Yellow	56968
# 6,000	2 μ	Light Blue	56969
# 10,000	1 μ	Yellow	56970

Adhesive Back

Diamond files for precise finishing. Highly durable, they retain sharpness even after long use.

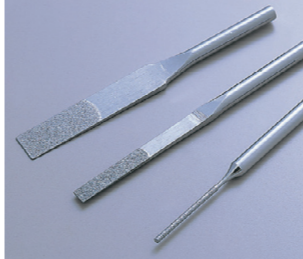

1 pc./pack SHANK $\phi 3.0$ Diamond Files (Flat Taper)

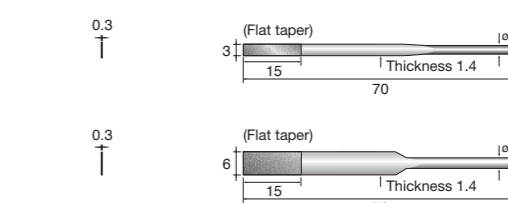

Grit	62301
# 200	62301
# 400	62302
# 600	62303

Grit	62305
# 200	62305
# 400	62306
# 600	62307

1 pc./pack SHANK $\phi 3.0$ Diamond Files (Flat, Half-Round, Round, Angular)

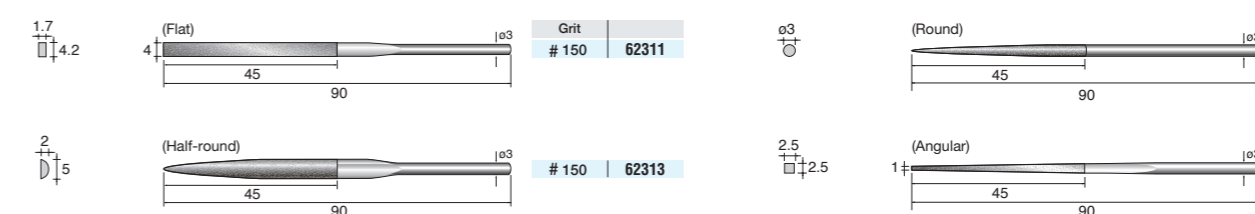

Grit	62311
# 150	62311

Grit	62315
# 150	62315

Grit	62313
# 150	62313

Grit	62317
# 150	62317

1 pc./pack SHANK $\phi 3.0$ Diamond Files (Flat Taper, Flat)

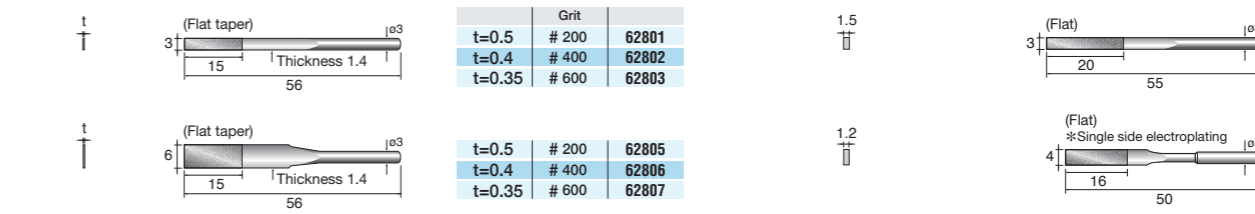

Grit	62801
t=0.5 # 200	62801
t=0.4 # 400	62802
t=0.35 # 600	62803

Grit	62805
t=0.5 # 200	62805
t=0.4 # 400	62806
t=0.35 # 600	62807

Grit	62811
# 150	62811
# 200	62812
# 400	62813

Grit	62814
# 100	62814

1 pc./pack SHANK $\phi 3.0$ Diamond Files (Flat, Angular)

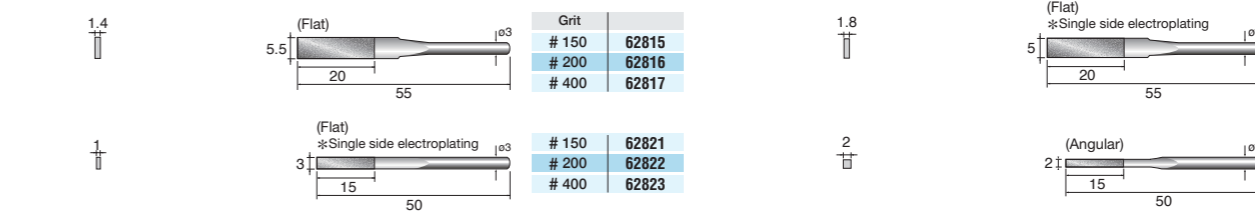

Grit	62815
# 150	62815
# 200	62816
# 400	62817

Grit	62821
# 150	62821
# 200	62822
# 400	62823

Grit	62825
# 150	62825
# 200	62826
# 400	62827

Grit	62831
# 150	62831
# 200	62832
# 400	62833

Diamond / CBN
Carbide Cutters
Specialty Tools
Mounted Points
Rubberized Abrasives
Flap Wheels
Polishing Brushes
Felt Bobs
Abrasive Compounds & Polishing Tools
NSK Exclusive Tools

Diamond / CBN
Carbide Cutters
Specialty Tools
Mounted Points
Rubberized Abrasives
Flap Wheels
Polishing Brushes
Felt Bobs
Abrasive Compounds & Polishing Tools
NSK Exclusive Tools

ABRASIVE COMPOUNDS & POLISHING TOOLS

SHANK $\phi 3.0$
1 pc./pack **Diamond Files (Round, Round taper)**

$\phi 1$	(Round)	Grit	
		# 100	62840
		# 150	62841
		# 200	62842
$\phi 2$	(Round)	Grit	
		# 150	62845
		# 200	62846
		# 400	62847

$\phi 3$	(Round)	Grit	
		# 150	62851
		# 200	62852
		# 400	62853
$\phi 0.5$	(Round Taper)	Grit	
		# 150	62855
		# 200	62856
		# 400	62857

SHANK $\phi 3.0$
1 pc./pack **Diamond Files (Half-Round, Triangular)**

$\phi 1.5$	(Half-round)	Grit	
		# 150	62865
		# 200	62866
$\phi 2$	(Half-round)	Grit	
		# 150	62871
		# 200	62872
$\phi 4$	(Half-round)	Grit	
		# 200	62872
		# 400	62873

$\phi 2.6$	(Triangular)	Grit	
		# 150	62881
		# 200	62882
		# 400	62883

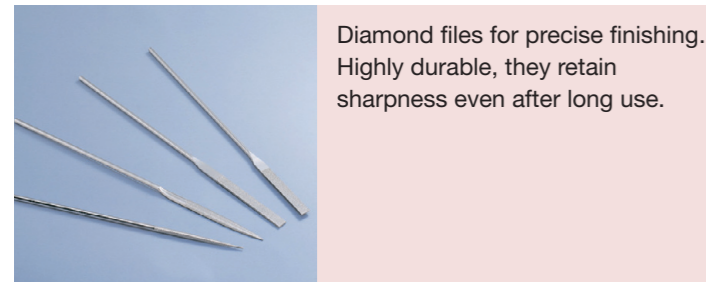

Diamond files for precise finishing. Highly durable, they retain sharpness even after long use.

SHANK $\phi 3.0$
1 pc./pack **Diamond Files (Flat Taper)**

$\phi 0.6$	(Flat taper)	Thickness 1.7	Grit	
			# 200	57101
			# 400	57102
$\phi 0.6$	(Flat taper)	Thickness 1.7	Grit	
			# 200	57104
			# 400	57105
$\phi 0.6$	(Flat taper)	Thickness 1.7	Grit	
			# 400	57105
			# 600	57106

SHANK $\phi 3.0$
1 pc./pack **Diamond Files (Flat Taper, Thin Flat, Flat)**

$\phi 0.6$	(Flat taper)	Thickness 1.7	Grit	
			# 200	57107
			# 400	57108
$\phi 0.6$	(Flat taper)	Thickness 1.7	Grit	
			# 400	57109
			# 600	57109
$\phi 0.5$	(Thin flat)		Grit	
			# 150	57110
			# 200	57111
$\phi 0.5$	(Thin flat)		Grit	
			# 200	57111
			# 400	57112

$\phi 0.8$	(Thin flat)	Grit	
		# 150	57113
		# 200	57114
$\phi 0.8$	(Thin flat)	Grit	
		# 200	57114
		# 400	57115
$\phi 1.4$	(Flat)	Grit	
		# 120	57116
		# 200	57117
$\phi 1.4$	(Flat)	Grit	
		# 200	57117
		# 400	57118

SHANK $\phi 1.0, \phi 2.0, \phi 3.0, \phi 3.4$
1 pc./pack **Diamond Files (Round)**

$\phi 1$	(Round)	Grit	
		# 200	57131
		# 400	57132
$\phi 2$	(Round)	Grit	
		# 200	57133
		# 400	57134

$\phi 3$	(Round)	Grit	
		# 120	57135
		# 200	57136
$\phi 3$	(Round)	Grit	
		# 200	57136
		# 400	57137
$\phi 3.5$	(Round)	Grit	
		# 120	57138
		# 200	57139

SHANK $\phi 3.0, \phi 3.4$
1 pc./pack **Diamond Files (Half-Round)**

$\phi 2$	(Half-round)	Grit	
		# 120	57141
		# 200	57142
$\phi 2$	(Half-round)	Grit	
		# 120	57144
		# 200	57145

SHANK $\phi 3.0, \phi 3.4$
1 pc./pack **Diamond Files (Angular)**

$\phi 2.5$	(Angular)	Grit	
		# 120	57151
		# 200	57152
$\phi 3$	(Angular)	Grit	
		# 200	57154

ABRASIVE COMPOUNDS & POLISHING TOOLS

SHANK $\phi 3.0, \phi 3.4$
1 pc./pack **Diamond Files (Triangular, Elliptical, Blade)**

$\phi 3.5$	(Triangular)	Grit	
		# 120	57155
$\phi 3.5$	(Triangular)	Grit	
		# 200	57156
$\phi 4$	(Triangular)	Grit	
		# 100	57157
$\phi 4$	(Triangular)	Grit	
		# 200	57158

$\phi 2$	(Elliptical)	Grit	
		# 120	57160
$\phi 2$	(Elliptical)	Grit	
		# 200	57161
$\phi 1.7$	(Blade)	Grit	
		# 120	57162
$\phi 1.7$	(Blade)	Grit	
		# 200	57163

SHANK $\phi 3.0$
1 pc./pack **Diamond Files (Sickle Type)**
(Flat, Round, Half-Round, Angular, Triangular)

$\phi 6$	(Flat)	Grit	
		# 150	57171
$\phi 3$	(Round)	Grit	
		# 150	57173

$\phi 1.5$	(Half-round)	Grit	
		# 150	57175
$\phi 2.5$	(Angular)	Grit	
		# 150	57177
$\phi 3.5$	(Triangular)	Grit	
		# 150	57179

SHANK $\phi 3.0, \phi 3.5$
3 pcs./pack **Precision Finishing Files (Flat, Round, Angular, Triangular, Half-Round)**

Total length The length of file	140mm		180mm
	70mm	90mm	Standard
1.3(1.5)	Standard	Fine	Standard
5.1(6)	57301	57311	57321
3(3.5)	57302	57312	57322
2.5(2.7)	57303	57313	57323

Total length The length of file	140mm		180mm
	70mm	Fine	Standard
3.3(4.1)	57304	57314	57324
2	57305	57315	57325

- 5 files-pack set
- Standard (total length 140mm) set (No.57301-No.57305 : 1 pc. each) 57309
- Fine (total length 140mm) set (No.57311-No.57315 : 1 pc. each) 57319
- Standard (total length 180mm) set (No.57321-No.57325 : 1 pc. each) 57329

SHANK $\phi 3.0$
3 pcs./pack **Rasps for plastics and wood working (Flat, Round, Angular, Triangular, Half-Round)**

$\phi 2.2$	(Flat)	57401
	(Round)	57402
	(Angular)	57403

$\phi 3.8$	(Triangular)	57404
	(Half-round)	57405

- 5 files-pack set
- Rasps set for plastics and wood working for plastics and wood working (No.57401-No.57405 : 1 pc. each) 57410

SHANK $\phi 3.0$
1 pc./pack **Special Grip Handle**
• Attachable shank diameter is $\phi 2-4$ mm



SHANK $\phi 3.0$
1 pc./pack **Diamond Hand Dresser**
• Light weight, electroplated diamond dresser. Ideally suited to a wide variety of applications.

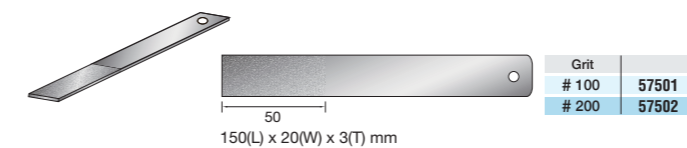

SHANK $\phi 3.0$
1 pc./pack **Diamond Block Dresser**
• Can be molded for purpose use, by turning a work with axis, or by vibrating and pushing a stick abrasive material.

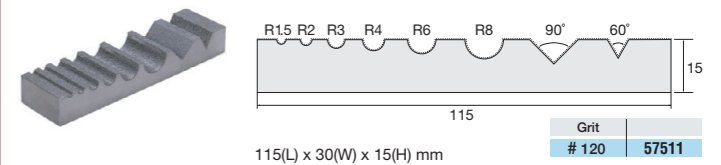

Diamond / CBN
Carbide Cutters
Specialty Tools
Mounted Points
Rubberized Abrasives
Flap Wheels
Polishing Brushes
Felt Bobs
Abrasive Compounds & Polishing Tools
NSK Exclusive Tools

Diamond / CBN

Carbide Cutters

Specialty Tools

Mounted Points

Rubberized Abrasives

Flap Wheels

Polishing Brushes

Felt Bobs

Abrasive Compounds & Polishing Tools

NSK Exclusive Tools

Diamond / CBN

Carbide Cutters

Specialty Tools

Mounted Points

Rubberized Abrasives

Flap Wheels

Polishing Brushes

Felt Bobs

Abrasive Compounds & Polishing Tools

NSK Exclusive Tools

Diamond / CBN

Carbide Cutters

Specialty Tools

Mounted Points

Rubberized Abrasives

Flap Wheels

Polishing Brushes

Felt Bobs

Abrasive Compounds & Polishing Tools

NSK Exclusive Tools

Diamond / CBN

Carbide Cutters

Specialty Tools

Mounted Points

Rubberized Abrasives

Flap Wheels

Polishing Brushes

Felt Bobs

Abrasive Compounds & Polishing Tools

NSK Exclusive Tools

Diamond / CBN

Carbide Cutters

Specialty Tools

Mounted Points

Rubberized Abrasives

Flap Wheels

Polishing Brushes

Felt Bobs

Abrasive Compounds & Polishing Tools

NSK Exclusive Tools

Diamond / CBN

Carbide Cutters

Specialty Tools

Mounted Points

Rubberized Abrasives

Flap Wheels

Polishing Brushes

Felt Bobs

Abrasive Compounds & Polishing Tools

NSK Exclusive Tools

Diamond / CBN

Carbide Cutters

Specialty Tools

Mounted Points

Rubberized Abrasives

Flap Wheels

Polishing Brushes

Felt Bobs

Abrasive Compounds & Polishing Tools

NSK Exclusive Tools

Diamond / CBN

Carbide Cutters

Specialty Tools

Mounted

ABRASIVE COMPOUNDS & POLISHING TOOLS

1 pc./pack Grindstone Dresser
 • Used for dressing diamond / CBN wheels, metal or resin bond.



Handy Type	Size	WA		GC	
		#	#	#	#
Stick Type	Flat Plate Type 75(W) x 25(D) x 8(H) mm	57521 (#80)	57526 (#80)		
	Mini Type 50(W) x 7(D) x 7(H) mm	57531 (#200)	57536 (#360)		
	100(W) x 20(D) x 15(H) mm	57541 (#200)	57546 (#360)		

1 pc./pack Natural Diamond Single Stone Dresser
 • Used for dressing or shaping standard grindstones.



* Shank diameter : ϕ 11mm
 Length : 100mm

No. of Carats	Recommended Grindstone Outer Diameter	
1/4 (0.25ct)	ϕ 75mm	57551
1/2 (0.5ct)	ϕ 150~200mm	57552
3/4 (0.75ct)	ϕ 255~300mm	57553
1ct	ϕ 300~355mm	57554

1 pc./pack Tooling Block Dresser
 • Dresser with electroplated diamonds on a block metal surface.

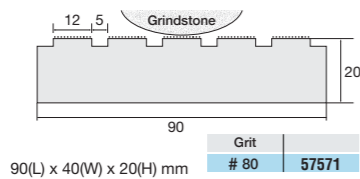
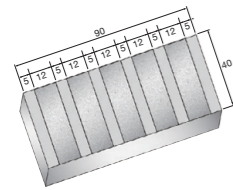

1 pc./pack Imprint Dresser For Truing
 • Used to adjust the grinding surface of diamond, CBN foil and standard grindstones.

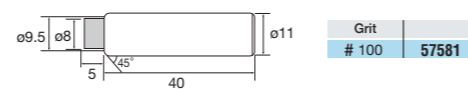

NAKANISHI's EXCLUSIVE TOOLS

Exclusive Tools of Ultrasonic Polisher "SHEENUS NEO"



Special electroplated diamond files of Nakanishi's ultrasonic polisher "SHEENUS NEO". Ideal for fine burr removal and rough finishing.

1 pc./pack Electroplated Diamond File

Shape	Thickness	Grit	
Flat taper	0.4	# 200	60101
		# 320	60102
		# 600	60103
Flat	1*	# 200	60105
		# 320	60106
		# 600	60107
Flat bent	1	# 200	60111
		# 320	60112
		# 600	60113
Column with the rounded edge	1	# 200	60151
		# 320	60152
		# 600	60153
Column with the rounded edge	2	# 200	60155
		# 320	60156
		# 600	60157
Round taper (cone-shaped)	3	# 200	60181
		# 320	60182
		# 600	60183

*60107 is thickness 0.8mm.

Shape	Thickness	Grit	
Triangular taper (Triangular pyramid)	3	# 200	60185
		# 320	60186
		# 600	60187
Oval taper	2	# 200	60191
		# 320	60192
		# 600	60193
Flat long	1	# 200	60115
		# 320	60116
		# 600	60117
Flat long taper	5	# 200	60231
		# 320	60232
		# 600	60233
Flat long taper	8	# 200	60235
		# 320	60236
		# 600	60237

2 pcs./pack Ceramic Fiber Grindstone (Total Length 50 mm)

• Alumina fiber abrasive with the strength and the flexibility for rough or fine finishing.

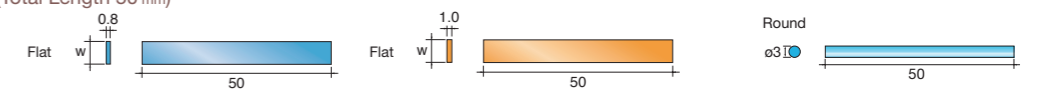

Grit	Color	W = 4 mm	W = 6 mm	Grit	Color	ϕ 3 mm
# 180	Ivory	60701	60711	# 180	Ivory	63101
# 300	Brown	60702	60712	# 300	Brown	63102
# 400	Orange	60703	60713	# 400	Orange	63103
# 600	Black	60704	60714	# 600	Black	63104
# 800	Blue	60705	60715	# 800	Blue	63105
# 1,000	White	60706	60716	# 1,000	White	63106
# 1,200	Pink	60707	60717	# 1,200	Pink	63107

5 pcs./pack Brass Lapping Tip (Total Length 40 mm)

• Lapping tools for finishing using diamond or abrasive compounds.

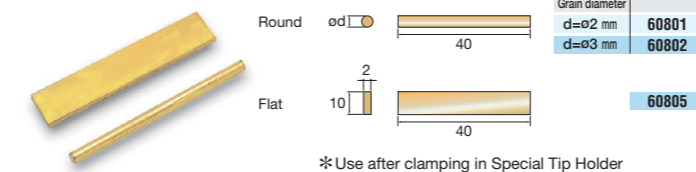

10 pcs./pack Wood Lapping Tip (Total Length 40 mm)

• Lapping tools for finishing using diamond or abrasive compounds.

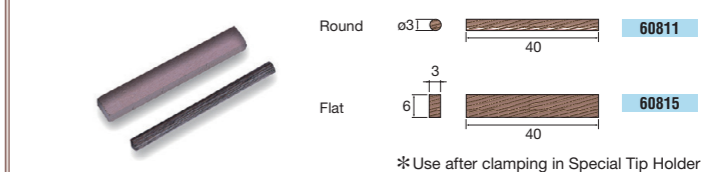

2 pcs./pack Special Tip Holder • Choose by tip size and shape.

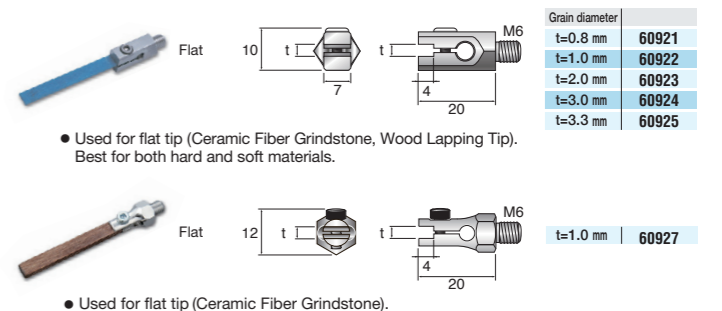
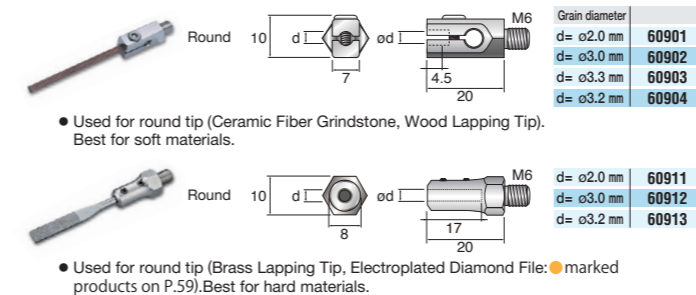

Diamond / CBN, Carbide Cutters, Specialty Tools, Mounted Points, Rubberized Abrasives, Flap Wheels, Polishing Brushes, Felt Bobs, Abrasive Compounds & Polishing Tools, NSK Exclusive Tools

Diamond / CBN

Carbide Cutters

Specialty Tools

Mounted Points

Rubberized Abrasives

Flap Wheels

Polishing Brushes

Felt Bobs

Abrasive Compounds & Polishing Tools

NSK Exclusive Tools

Diamond / CBN

Carbide Cutters

Specialty Tools

Mounted Points

Rubberized Abrasives

Flap Wheels

Polishing Brushes

Felt Bobs

Abrasive Compounds & Polishing Tools

NSK Exclusive Tools

Diamond / CBN

Carbide Cutters

Specialty Tools

Mounted Points

Rubberized Abrasives

Flap Wheels

Polishing Brushes

Felt Bobs

Abrasive Compounds & Polishing Tools

NSK Exclusive Tools

Diamond / CBN

Carbide Cutters

Specialty Tools

Mounted Points

Rubberized Abrasives

Flap Wheels

Polishing Brushes

Felt Bobs

Abrasive Compounds & Polishing Tools

NSK Exclusive Tools

Diamond / CBN

Carbide Cutters

Specialty Tools

Mounted Points

Rubberized Abrasives

Flap Wheels

Polishing Brushes

Felt Bobs

Abrasive Compounds & Polishing Tools

NSK Exclusive Tools

Diamond / CBN

Carbide Cutters

Specialty Tools

Mounted Points

Rubberized Abrasives

Flap Wheels

Polishing Brushes

Felt Bobs

Abrasive Compounds & Polishing Tools

NSK Exclusive Tools

Diamond / CBN

Carbide Cutters

Specialty Tools

Mounted Points

Rubberized Abrasives

Flap Wheels

Polishing Brushes

Felt Bobs

Abrasive Compounds & Polishing Tools

NSK Exclusive Tools

Diamond / CBN

Carbide Cutters

Specialty Tools

Mounted Points

Rubberized Abrasives

Flap Wheels

Polishing Brushes

Felt Bobs

Abrasive Compounds & Polishing Tools

NSK Exclusive Tools

Diamond / CBN

Carbide Cutters

Specialty Tools

Mounted Points

Rubberized Abrasives

Flap Wheels

Polishing Brushes

Felt Bobs

Abrasive Compounds & Polishing Tools

NSK Exclusive Tools

Diamond / CBN

Carbide Cutters

Specialty Tools

Mounted Points

Rubberized Abrasives

Flap Wheels

Polishing Brushes

Felt Bobs

Abrasive Compounds & Polishing Tools

NSK Exclusive Tools

Diamond / CBN

Carbide Cutters

Specialty Tools

Mounted Points

Rubberized Abrasives

Flap Wheels

Polishing Brushes

Felt Bobs

Abrasive Compounds & Polishing Tools

NSK Exclusive Tools

Diamond / CBN

Carbide Cutters

Specialty Tools

Mounted Points

Rubberized Abrasives

Flap Wheels

Polishing Brushes

Felt Bobs