

**ABRASIVE COMPOUNDS & POLISHING TOOLS**

**1 pc./pack Grindstone Dresser**  
 • Used for dressing diamond / CBN wheels, metal or resin bond.



Handy Type	Size	WA		GC	
		#	#	#	#
Stick Type	Flat Plate Type 75(W) x 25(D) x 8(H) mm	57521 (#80)	57526 (#80)		
	Mini Type 50(W) x 7(D) x 7(H) mm	57531 (#200)	57536 (#360)		
	100(W) x 20(D) x 15(H) mm	57541 (#200)	57546 (#360)		

**1 pc./pack Natural Diamond Single Stone Dresser**  
 • Used for dressing or shaping standard grindstones.



\* Shank diameter :  $\phi$ 11mm  
 Length : 100mm

No. of Carats	Recommended Grindstone Outer Diameter	
1/4 (0.25ct)	$\phi$ 75mm	57551
1/2 (0.5ct)	$\phi$ 150-200mm	57552
3/4 (0.75ct)	$\phi$ 255-300mm	57553
1ct	$\phi$ 300-355mm	57554

**1 pc./pack Tooling Block Dresser**  
 • Dresser with electroplated diamonds on a block metal surface.

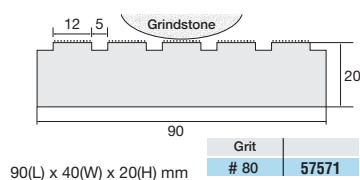
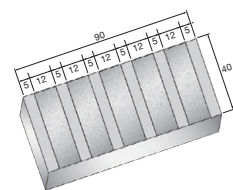

**1 pc./pack Imprint Dresser For Truing**  
 • Used to adjust the grinding surface of diamond, CBN foil and standard grindstones.

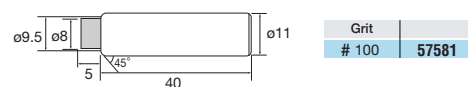

**NAKANISHI's EXCLUSIVE TOOLS**

**Exclusive Tools of Ultrasonic Polisher "SHEENUS NEO"**



Special electroplated diamond files of Nakanishi's ultrasonic polisher "SHEENUS NEO". Ideal for fine burr removal and rough finishing.

**1 pc./pack Electroplated Diamond File**

Shape	Thickness	Grit	
Flat taper	0.4	# 200	60101
		# 320	60102
		# 600	60103
Flat	1*	# 200	60105
		# 320	60106
		# 600	60107
Flat bent	1	# 200	60111
		# 320	60112
		# 600	60113
Column with the rounded edge	1	# 200	60151
		# 320	60152
		# 600	60153
Column with the rounded edge	2	# 200	60155
		# 320	60156
		# 600	60157
Round taper (cone-shaped)	3	# 200	60181
		# 320	60182
		# 600	60183

\*60107 is thickness 0.8mm.

Shape	Thickness	Grit	
Triangular taper (Triangular pyramid)	3	# 200	60185
		# 320	60186
		# 600	60187
Oval taper	2	# 200	60191
		# 320	60192
		# 600	60193
Flat long	1	# 200	60115
		# 320	60116
		# 600	60117
Flat long taper	1	# 200	60231
		# 320	60232
		# 600	60233
Flat long taper	1	# 200	60235
		# 320	60236
		# 600	60237

**2 pcs./pack Ceramic Fiber Grindstone (Total Length 50 mm)**

• Alumina fiber abrasive with the strength and the flexibility for rough or fine finishing.

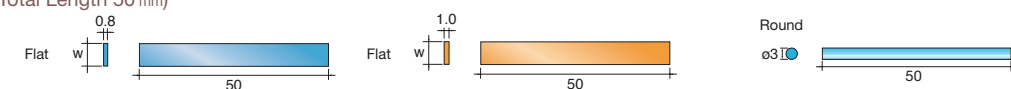

Grit	Color	W = 4 mm	W = 6 mm	Grit	Color	$\phi$ 3 mm
# 180	Ivory	60701	60711	# 180	Ivory	63101
# 300	Brown	60702	60712	# 300	Brown	63102
# 400	Orange	60703	60713	# 400	Orange	63103
# 600	Black	60704	60714	# 600	Black	63104
# 800	Blue	60705	60715	# 800	Blue	63105
# 1,000	White	60706	60716	# 1,000	White	63106
# 1,200	Pink	60707	60717	# 1,200	Pink	63107

**5 pcs./pack Brass Lapping Tip (Total Length 40 mm)**

• Lapping tools for finishing using diamond or abrasive compounds.

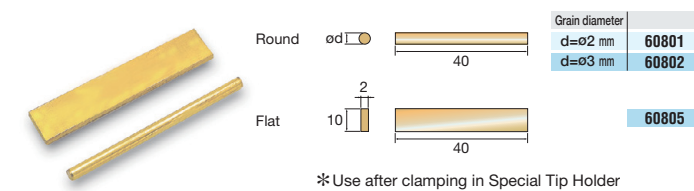

**10 pcs./pack Wood Lapping Tip (Total Length 40 mm)**

• Lapping tools for finishing using diamond or abrasive compounds.

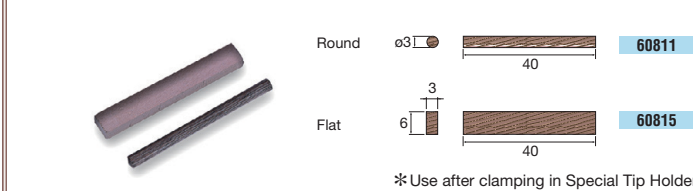

**2 pcs./pack Special Tip Holder** • Choose by tip size and shape.

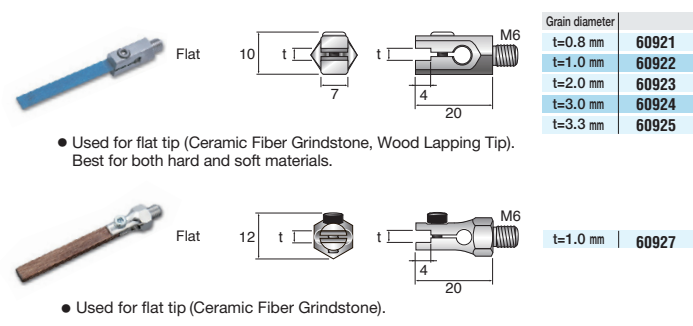
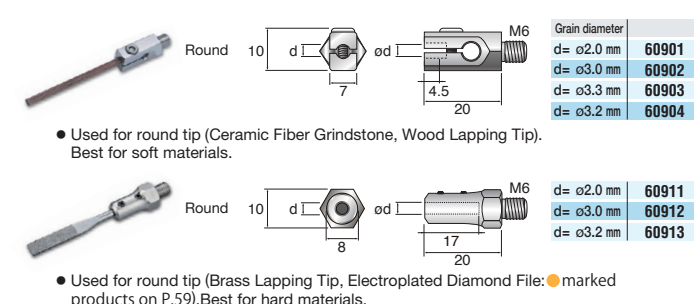

Diamond / CBN  
Carbide Cutters  
Specialty Tools  
Mounted Points  
Rubberized Abrasives  
Flap Wheels  
Polishing Brushes  
Felt Bobs  
Abrasive Compounds & Polishing Tools  
NSK Exclusive Tools

Diamond / CBN  
Carbide Cutters  
Specialty Tools  
Mounted Points  
Rubberized Abrasives  
Flap Wheels  
Polishing Brushes  
Felt Bobs  
Abrasive Compounds & Polishing Tools  
NSK Exclusive Tools

**NAKANISHI's EXCLUSIVE TOOLS**

**2 pcs./pack M4 Screw Joint Adaptor**

- Connection adaptor for attaching M4 screw tool to SHEENUS handpiece (SHEENUS ID thread is M6).

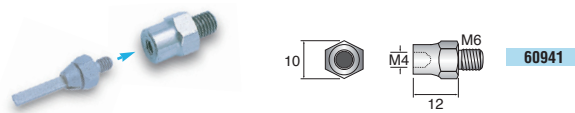

**Exclusive Tools of Electromotive Polisher "LUSTER", "MINI-LUSTER", "SWING-LUSTER"**



**LUSTER**

Best for finishing large open work areas.

- Marked tools can be used for Sheenus neo with the Tip Holder. (60912)

**SHANK ø3.0**

**1 pc./pack Electroplated Diamond File**

Flat taper Thickness 1.4 # 200 62301 # 400 62302 # 600 62303	Half-round # 150 62313
Flat taper Thickness 1.4 # 200 62305 # 400 62306 # 600 62307	Round # 150 62315
Flat # 150 62311	Angular # 150 62317

**1 pc./pack Diamond File Flat Type**

- \* Use with stone holder No.62502.
- \* File part is flat taper.

# 150 t=0.7~1.3mm 62351	# 150 t=0.7~1.3mm 62361
# 200 t=0.6~1.2mm 62352	# 200 t=0.6~1.2mm 62362
# 400 t=0.5~1.0mm 62353	# 400 t=0.5~1.0mm 62363

**SHANK ø3.0, ø3.5**

**3 pcs./pack Precision Finishing Files (Flat, Round, Angular, Triangular, Half-Round)**

Total length The length of file	140mm		180mm	
	Standard	Fine	Standard	Fine
1.3(1.5) (Flat)	57301	57311	57321	
3(3.5) (Round)	57302	57312	57322	
2.5(2.7) (Angular)	57303	57313	57323	
3.3(4.1) (Triangular)	57304	57314	57324	
2 (Half-round)	57305	57315	57325	

5 files-pack set

- Standard (total length 140mm) set (No.57301~No.57305 : 1pc. each) ..... 57309
- Fine (total length 140mm) set (No.57311~No.57315 : 1pc. each) ..... 57319
- Standard (total length 180mm) set (No.57321~No.57325 : 1pc. each) ..... 57329

**SHANK ø3.0**

**3 pcs./pack Rasps for plastics and wood working (Flat, Round, Angular, Triangular, Half-Round)**

2.2 (Flat) 57401	3.8 (Triangular) 57404
3.8 (Round) 57402	2.3 (Half-round) 57405
3.3 (Angular) 57403	

5 files-pack set

- Rasps set for plastics and wood working for plastics and woodworking (No.57401~No.57405 : 1pc. each) ..... 57410

**NAKANISHI's EXCLUSIVE TOOLS**

**1 pc./pack Stone Holder**



**2 pcs./pack Ceramic Fiber Grindstone (Total Length 50 mm)**

- Alumina fiber abrasive with the strength and the flexibility for rough or fine finishing.



Flat	Flat	Round
W 0.8	W 1.0	ø3
50	50	50
Grit	Grit	Grit
# 180 Ivory 60701	# 180 Ivory 60721	# 180 Ivory 63101
# 300 Brown 60702	# 300 Brown 60722	# 300 Red 63102
# 400 Orange 60703	# 400 Orange 60723	# 400 Orange 63103
# 600 Black 60704	# 600 Black 60724	# 600 Black 63104
# 800 Blue 60705	# 800 Blue 60725	# 800 Blue 63105
# 1,000 White 60706	# 1,000 White 60726	# 1,000 White 63106
# 1,200 Pink 60707	# 1,200 Pink 60727	# 1,200 Pink 63107

**1 pc./pack Ceramic Fiber Grindstone Holder • Grindstone Holder**

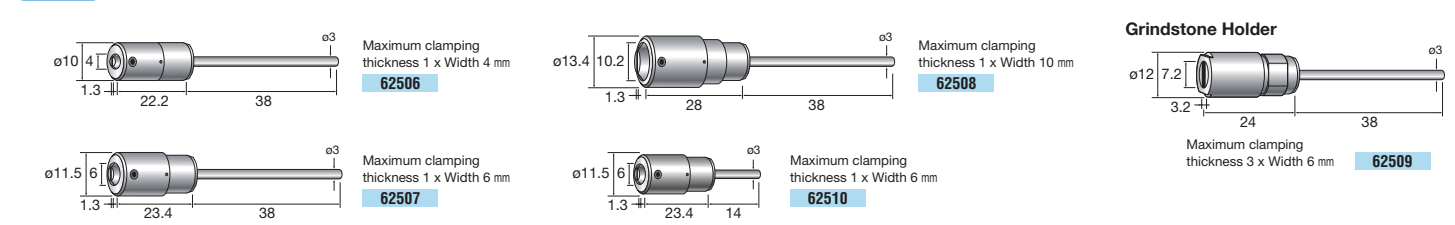

**1 pc./pack Flat Holder • Tip for use with abrasive sheets.**

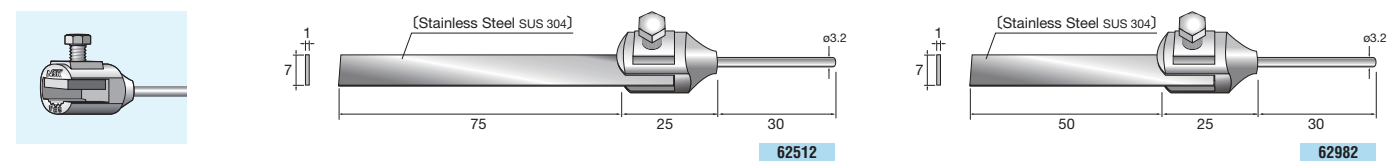

**1 pc./pack Angular Pad Holder**

- Holder for use with abrasive tips for polishing flat surfaces.

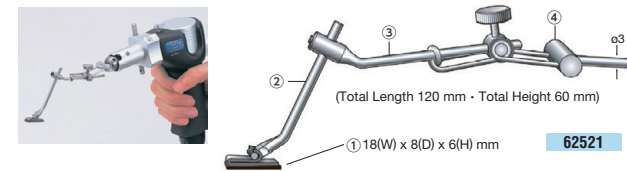

**Abrasive Tip (For Flat Holder and Angular Pad Holder)**

**100 pcs./pack Sand Paper Tip**

Grit	# 120	# 600
①	62525	62557
②	62526	62559
③	62527	62560
④	62751	

Adhesive Back

**3 pcs./pack Wood Tip Holder**

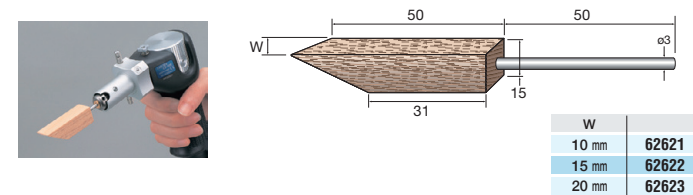

**1 pc./pack Spring Holder**

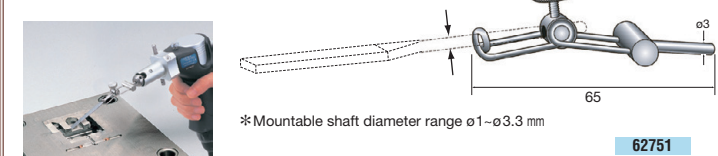



**NAKANISHI's EXCLUSIVE TOOLS**

**SHANK  $\phi$ 3.0**  
1 pc./pack Electroplated Diamond File

Flat taper		Thickness 1.4	t	Grit		Angular		Grit	
			0.5 mm	# 200	62801			# 150	62831
			0.4 mm	# 400	62802			# 200	62832
			0.35 mm	# 600	62803			# 400	62833
Flat taper		Thickness 1.4	0.5 mm	# 200	62805	Round		# 100	62840
			0.4 mm	# 400	62806			# 150	62841
			0.35 mm	# 600	62807			# 200	62842
								# 400	62843
Flat						Round		# 150	62845
								# 200	62846
								# 400	62847
Flat (Single side electroplating)						Round		# 150	62851
								# 200	62852
								# 400	62853
Flat						Round taper		# 150	62855
								# 200	62856
								# 400	62857
Flat (Single side electroplating)						Half-round		# 150	62865
								# 200	62866
								# 400	62867
Flat (Single side electroplating)						Half-round		# 150	62871
								# 200	62872
								# 400	62873
Flat (Single side electroplating)						Triangular		# 150	62881
								# 200	62882
								# 400	62883

**Exclusive Tools of "60° & 90° ANGLE"**

Special tools for Nakanishi Micro-grinder "Angle Attachment". Highly efficient for grinding, polishing, finishing, etc.

**SHANK  $\phi$ 3.0**  
5 pcs./pack Special Rubber Pad For Abrasive and Felt Disks

20,000 min<sup>-1</sup>

64101, 64102, 64103

**100 pcs./pack Sand Paper Disk**

**Cloth Type**  
• For Metals ... Both for dry and wet finishing (Adhesive is resistant to water and oil)

Grit	$\phi$ 11	$\phi$ 21	$\phi$ 31
# 60	64111	64121	64141
# 80	64112	64122	64142
# 120	64113	64123	64143
# 180	64114	64124	64144
# 240	64115	64125	64145
# 320	64116	64126	64146
# 400	64117	64127	64147
# 600	64118	64128	64148
# 800	64119	64129	64149
# 1,000	64120	64130	64150

Adhesive Back

**Paper Type**  
• For Metals ... Both for dry and wet finishing (Adhesive is resistant to water and oil)

Grit	$\phi$ 11	$\phi$ 21	$\phi$ 31
# 80	64131	64151	64171
# 120	64132	64152	64172
# 180	64133	64153	64173
# 240	64134	64154	64174
# 320	64135	64155	64175
# 400	64136	64156	64176
# 600	64137	64157	64177
# 800	64138	64158	64178
# 1,000	64139	64159	64179
# 1,500	64140	64160	64180

Adhesive Back

**Paper Type**  
• Dry type ... For Metal, Woodwork, Paint, Putty polishing, Dry use

Grit	$\phi$ 11	$\phi$ 21	$\phi$ 31
# 80	64201	64211	64221
# 120	64202	64212	64222
# 180	64203	64213	64223
# 240	64204	64214	64224
# 320	64205	64215	64225
# 400	64206	64216	64226
# 600	64207	64217	64227

Adhesive Back

**NAKANISHI's EXCLUSIVE TOOLS**

**100 pcs./pack Zirconium Disk**  
• Best for finishing aluminum, stainless steel, copper alloy, brass, etc.

Grit	$\phi$ 11	$\phi$ 21	$\phi$ 31
# 60	64251	64261	64271
# 80	64252	64262	64272
# 120	64253	64263	64273
# 150	64254	64264	64274

Adhesive Back

**20 pcs./pack Fiber Disk**  
• Soft finishing can be done on flat & curved surfaces, due to superior flexibility.

Grit	Color	$\phi$ 11	$\phi$ 21	$\phi$ 31
# 120	Brown	64281	64291	64301
# 240	Violet	64282	64292	64302
# 320	Red Brown	64283	64293	64303
# 600	Dark Blue	64284	64294	64304
# 800	Gray	64285	64295	64305
# 1,000	Orange	64286	64296	64306

\*Thickness 3 mm Adhesive Back

**20 pcs./pack Felt Disk**  
• Ideal for finishing using abrasives and diamond compounds.

Description	$\phi$ 11	$\phi$ 21	$\phi$ 31
Soft Type Felt Disk (1mm thickness)	64331	64332	64333
Soft Type Felt Disk (2mm thickness)	64335	64336	64337

Adhesive Back

**20 pcs./pack Felt Disk Chromium Oxide (Blue Rouge) Embedded Type.**  
• Useful for speedy finishing because of Chromium Oxide (Blue Rouge) Embedded.

Description	$\phi$ 11	$\phi$ 21	$\phi$ 31
Felt Disk Chromium Oxide (Blue Rouge) Embedded Type. (2mm thickness)	64341	64342	64343

Adhesive Back

**20 pcs./pack Rubber Points Disk**  
• Best for coarse finishing, pre-finishing with great polishing power.

Grit	Color	$\phi$ 20	$\phi$ 30
# 60	Brown	64391	64401
# 80	Red	64392	64402
# 120	Dark Green	64393	64403
# 180	Olive	64394	64404
# 220	Green	64395	64405
# 320	Brown	64396	64406

\*Thickness 3mm. Adhere to special rubber pads and use. Adhesive Back.

**SHANK  $\phi$ 3.0**  
5 pcs./pack Mounted Rubber Disks (Rubber Pad Integration)

• Moderately hard abrasive grain have great polishing ability.

15,000 min<sup>-1</sup>

Grit	Color	WA	GC
# 80	Pink	64411	—
# 80	Purple	—	64421
# 120	Blue	64412	64422
# 180	Yellow	64413	—
# 180	Green	—	64423
# 220	Green	64414	64424
# 320	Purple	64415	64425
# 500	Orange	64416	—
# 500	Brown	—	64426

For preliminary finishing (Fast grinding)

Grit	Color	WA
# 80	Black (Red Line)	64431
# 120	Black (Blue Line)	64432

**1 pc./pack Diamond Disk (Fully Electroplated Type)**  
• Superior in sharpness and durability.

Grit	$\phi$ 11	$\phi$ 21	$\phi$ 31
# 100	64451	64461	64471
# 140	64452	64462	64472
# 200	64453	64463	64473
# 280	64454	64464	64474
# 400	64455	64465	64475
# 600	64456	64466	64476
# 800	64457	64467	64477
# 1,000	64458	64468	64478

Adhesive Back

**1 pc./pack Diamond Disk (Dot Electroplated Type, Wet Type)**  
• Electroplated nickel-alloy pellet is strongly adhered to resin base.

Grit	Color	$\phi$ 11	$\phi$ 21	$\phi$ 31
# 60	Green	64501	64511	64521
# 120	Black	64502	64512	64522
# 200	Red	64503	64513	64523
# 400	Yellow	64504	64514	64524
# 800	Gray	64505	64515	64525

Adhesive Back

**NAKANISHI's EXCLUSIVE TOOLS**

**3 pcs./pack Resin Bond Diamond Disk Star Pattern**

Star Pattern	Grit	o11	o21	o31
	# 80	64531	64541	64551
	# 120	64532	64542	64552
	# 180	64533	64543	64553
	# 240	64534	64544	64554
	# 400	64535	64545	64555
	# 600	64536	64546	64556
	# 800	64537	64547	64557
	# 1,000	64538	64548	64558
	# 2,000	64539	64549	64559

Adhesive Back

\*Patterns may be changed without notice

**3 pcs./pack Lapping Film Disk Diamond Abrasive**

Diamond Film (Diamond)	Grit	Color	o11	o21	o31
	# 400	Ivory	64601	64606	64611
	# 800	Ivory	64602	64607	64612
	# 1,500	Ivory	64603	64608	64613
	# 3,000	Ivory	64604	64609	64614

Adhesive Back

**50 pcs./pack Lapping Film Disk WA Abrasive**

Arandom Film (WA)	Grit	Color	o11	o21	o31
	# 320	Pink	64621	64626	64631
	# 600	Green	64622	64627	64632
	# 1,000	Orange	64623	64628	64633
	# 1,500	Olive	64624	64629	64634
	# 3,000	Violet	64625	64630	64635

Adhesive Back

**SHANK o3.0 1 pc./pack Electroplated Diamond File**

• Plastic and brass lapping rings for use with abrasive and diamond compounds.

**10 pcs./pack Replacement Plastic Ring**

64713 64717

**5 pcs./pack Replacement Brass Ring**

64723 64727

**1 pc./pack Replacement Holder**

64731 64732

**Exclusive Tools of "90° MINI ANGLE TYPE ATTACHMENT"**

Steel cutters for radius grinding of deep cross holes for "Mini-Angle attachment". Ideal for radius grinding of holes or removing burrs from cross jigs, precision parts and inside surfaces of pipes.

MINI ANGLE TYPE E-max Evolution (Very Small Head)

MINI ANGLE TYPE E-max Evolution

**SHANK o1.6 1 pc./pack Steel Cutters For Deep Cross Hole Finishing**

64801 64802

**SHANK o1.6 1 pc./pack Diamond Coated Burs For Deep Cross Hole Finishing**

11131 11132 11133

**5 pcs./pack Diamond and CBN Coated Burs For Deep Cross Hole Finishing**

Diamond 11151 11152 11153 11154 11155 11156  
 CBN 11161 11162 11163 11164 11165 11166

**NAKANISHI's EXCLUSIVE TOOLS**

**Exclusive Tools of "IMPULSE"**

Special tools for Nakanishi Micro-grinder "IMPULSE". Excellent for grinding or polishing flat surfaces, edges with Nakanishi's high-power air grinder.

90° ANGLE IMPULSE · NA90-230

60° ANGLE IMPULSE · NA45-230

**5 pcs./pack Special Rubber Pad for Disk Abrasives**

64821 64822

**12 pcs./pack Cup Wheel**

Grit	Grade Hardness	o20	o30
# 36	Standard	64830	64835
# 46	Hard	64831	64836
# 80	Standard	64832	64837
# 80	Hard	—	64838

**5 pcs./pack Polishing Sander**

• Abrasive Disk for high speed rotation is made from overlapping abrasive cloths.

Grit	
# 80	64842
# 120	64844
# 180	64846
# 240	64847
# 400	64849

• Convenient Assorted set for trial polishing  
 All grain size (5 types x each 1 pc.)  
 Total 5 pcs.-pack ..... 64850

**10 pcs./pack Rubber Cup Wheel**

• Rubber Cup Wheel with high elasticity for grinding & polishing.

Grit	Color	
# 60	Brown	64851
# 80	Red	64852
# 120	Blue	64853
# 180	Olive	64854
# 220	Green	64855
# 320	Brown	64856

• Convenient Assorted set for trial polishing  
 All grain size (6 types x each 2 pcs.)  
 Total 12 pcs.-pack ..... 64859

**Exclusive Tools of "FINE BELT SANDER"**

FINE BELT SANDER E-max Evolution

**30 pcs./pack Abrasive Belts**

• High Quality Abrasive Belts are superior in grinding & durability.

For Grinding or Polishing of Metals (Length 300 mm)				For Woodwork (Length 300 mm)	
Grit	W = 4 mm	W = 6 mm	W = 8 mm	Grit	8 mm Width
# 80	64901	64911	64921	# 80	64941
# 120	64902	64912	64922	# 120	64942
# 180	64903	64913	64923	# 240	64943
# 240	64904	64914	64924		
# 320	64905	64915	64925		
# 400	64906	64916	64926		
# 600	—	—	64927		
# 800	—	—	64928		

• Assorted set for preliminary finishing (● Mark)  
 Grain size (4 types x each 10 pcs.), W = 8 mm  
 Total 40 pcs.-pack ..... 64931

• Assorted set for finishing (● Mark)  
 Grain size (4 types x each 10 pcs.), W = 8 mm  
 Total 40 pcs.-pack ..... 64932

• Assorted set for woodwork  
 All grain size (3 types x each 10 pcs.)  
 Total 30 pcs.-pack ..... 64955

Diamond / CBN  
Carbide Cutters  
Specialty Tools  
Mounted Points  
Rubberized Abrasives  
Flap Wheels  
Polishing Brushes  
Felt Bobs  
Abrasive Compounds & Polishing Tools  
NSK Exclusive Tools

Diamond / CBN  
Carbide Cutters  
Specialty Tools  
Mounted Points  
Rubberized Abrasives  
Flap Wheels  
Polishing Brushes  
Felt Bobs  
Abrasive Compounds & Polishing Tools  
NSK Exclusive Tools



**NAKANISHI's EXCLUSIVE TOOLS**

**3 pcs./pack Diamond Belt**

• For grinding and polishing of Carbide, Hardened steel, Steel, Special steels, Ceramic, FRP, etc.



**Hard Type** (Length 300 mm)

Grit	8mm Width
# 80	65011
# 120	65012
# 240	65014
# 320	65015
# 600	65017

• **Assorted set**  
All grain size (5 types x each 1 pc.)  
Total 5 pcs.-pack ..... **65019**



**Soft Type** (Length 300 mm)

Grit	8mm Width	Grit	8mm Width
# 120	65021	# 600	65025
# 180	65022	# 800	65026
# 240	65023	#1,000	65027
# 320	65024		
# 400	65028		

• **Assorted set**  
All grain size (8 types x each 1 pc.)  
Total 8 pcs.-pack ..... **65030**

**30 pcs./pack Silicone Belt**

• Best for polishing aluminum, stainless steel, brass



(Length 300 mm)

Grit	8mm Width
# 80	64971
# 100	64972
# 120	64973

• **Assorted set**  
All grain size (3 types x each 10 pcs.)  
Total 30 pcs.-pack ..... **64975**

# Protective Equipments

**Always use safety glasses, mask, face guard for your safety.**

## Safety Eyewear

1 pack  
1 pc.



### Glasses Type

• Frame : Plastic  
• Weight : 43 g

Code No.
<b>69101</b>



### Goggles Type

• Frame : Soft vinyl  
• Weight : 31 g

Code No.
<b>69102</b>

## Face Shield

1 pack  
1 pc.



### Curved surface Type

• Lens : Acrylic resin  
• Weight : 144 g

Code No.
<b>69105</b>



### Flat surface Type

• Lens : Acetate resin  
• Weight : 144 g

Code No.
<b>69106</b>

## Disposable Dust-proof Mask

1 pack  
5 pcs.



### Dust-proof mask

	Code No.
Head-mounted type	<b>69111</b>



### Dust-proof mask with exhaust valve

	Code No.
Head-mounted type	<b>69112</b>
Ear-mounted type	<b>69115</b>